



High Quality Surgical Instruments



Email: info@alfazeelatcorp.com

WhatsApp: +92 321 6150213

Website: www.alfazeelatcorp.com



Diagnostic



Percussion Hammers
 Perkussionshammer
 Martillos de Percusion

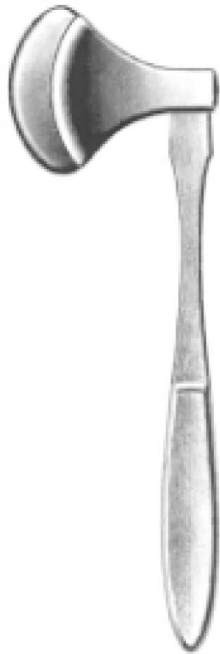

BERLINER
 40.0102.20
 20 cm

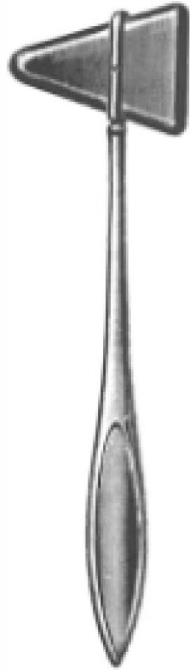

TAYLOR
 40.0106.20
 20 cm

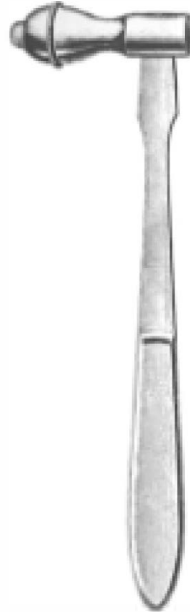

TRAUBE
 40.0110.17
 17 cm

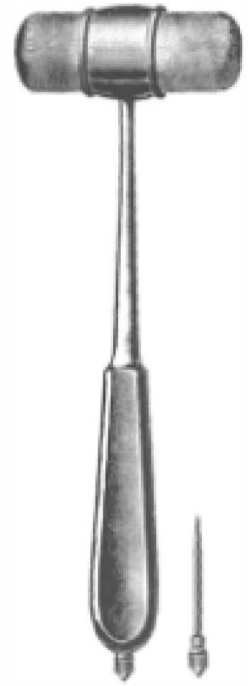

DEJERINE
 40.0114.21
 21 cm

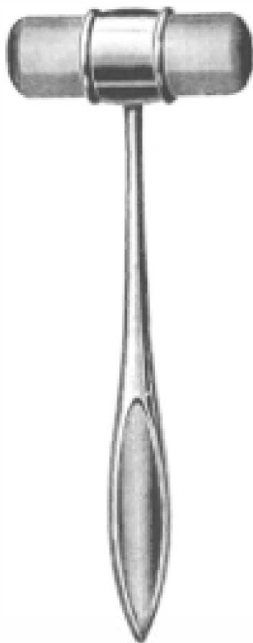

DEJERINE
 40.0118.20
 20 cm

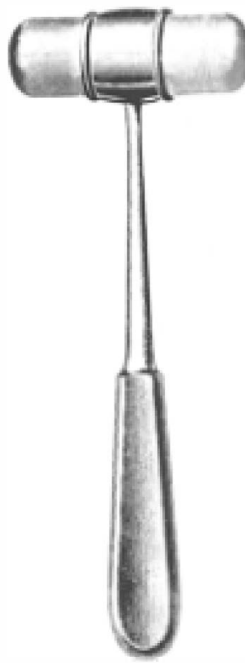

DEJERINE
 40.0122.20
 20 cm



TROEMNER
 40.0126.25
 25 cm

of aluminium
aus aluminium
de aluminio



PINARD
40.0130.15
15 cm

of wood
aus holz
de madera



PINARD
40.0134.14
14 cm



RABINER
40.0138.23
23 cm



EPSTEIN
40.0142.18
18 cm



BABINSKI
40.0146.22
22 cm



BABINSKI
40.0150.22
22 cm

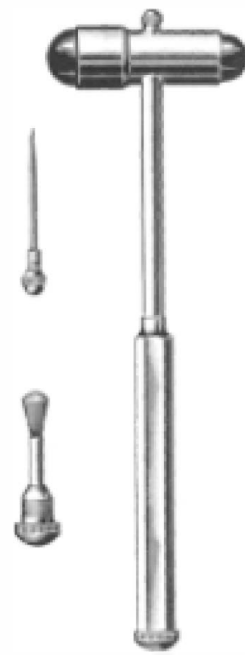

BUCK
40.0154.18
18 cm

Diagnostic Sets
Diagnostik-Bestecke
Juegos para diagnostico

40



OTOSCOPE SET
40-0170-00



BATTERY HANDLE
40-0174-01



OTOSCOPE HEAD
40-0178-02



CANNULA
40-0182-03
Ø 2 mm



CANNULA
40-0186-04
Ø 4 mm



ENT DIAGNOSTIC SET
 40-0190-00



BATTERY HANDLE
 40-0194-01



OTOSCOPE HEAD
 40-198-02



NASAL SPECULUM
 40-0202-03



OPHTHALMOSCOPE
 40-0206-04



TONGUE DEPRESSOR
 40-0210-05



LAMP SUPPORT
 40-0214-06



CANNULA
 40-0218-07
 Ø 4 mm



CANNULA
 40-0222-08
 Ø 2 mm



LARYNGEAL MIRROR
 40-0226-09



SPATULA HOLDER
 40-0230-10



Scalpels

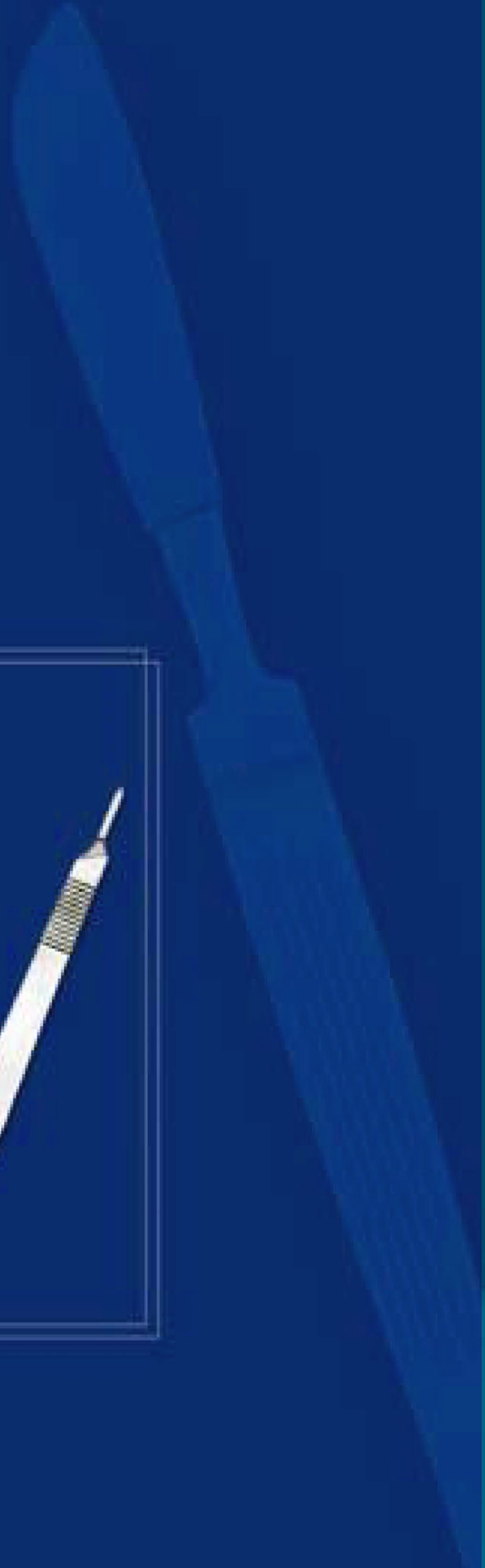

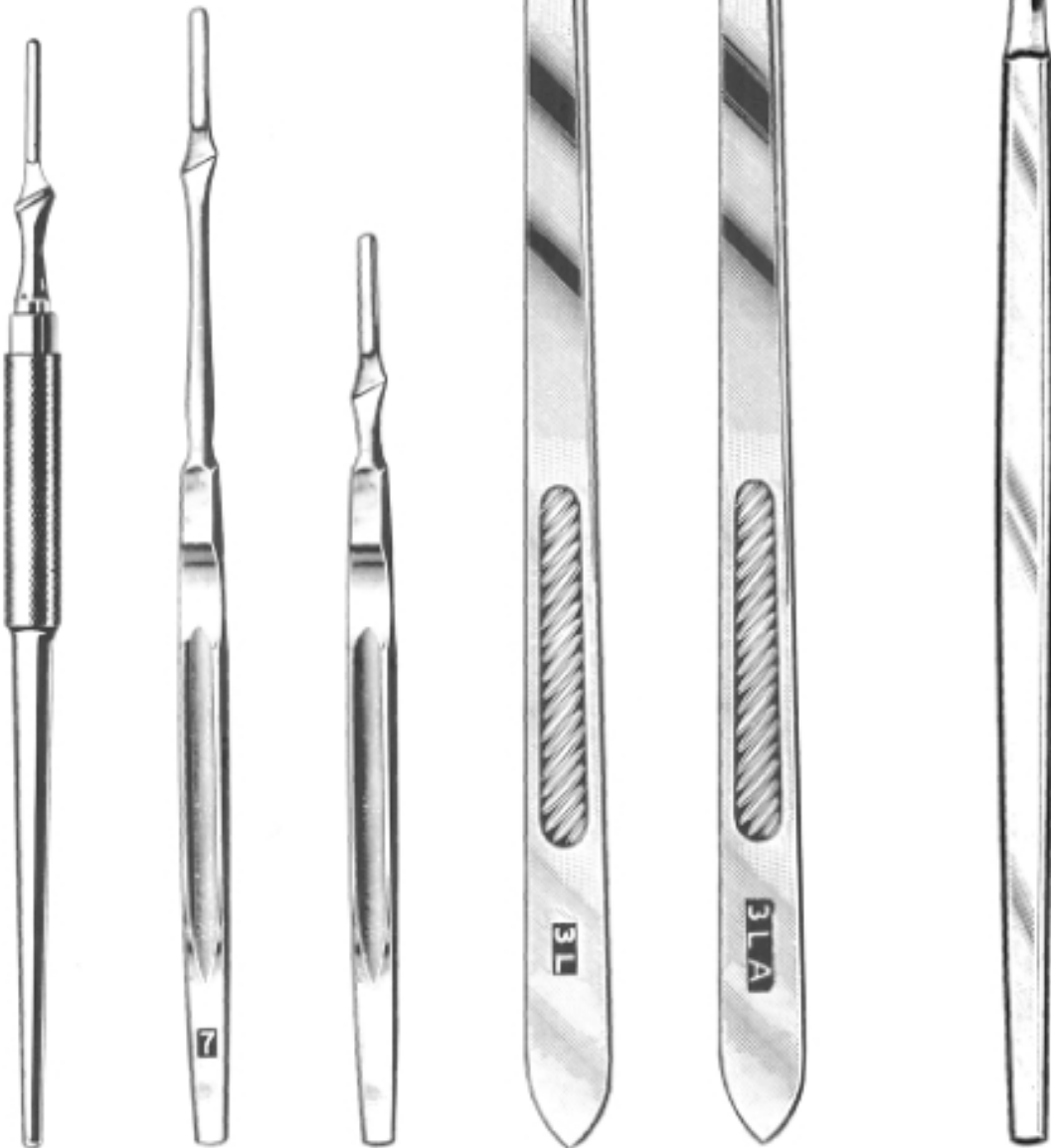

41.0102.16
16 cm

41.0106.07
no. 7

41.0110.07
no. 7k

41.0114.03
no. 3L
(25.058.00)

41.0115.03
no. 3LA

41.0118.22
22.5 cm

41

Scalpel Handles
Skalpelle - Griffe
Mangos de Bisturies



41.0122.08
(25,061.00)
no. 8



41.0130.09
no. 9



41.0134.03
(25,059.00)
no. 3



41.0138.04
(25,057.00)
no. 4

Scalpel Handles
 Skalpelle - Griffe
 Mangos de Bisturios

41



41.0142.22
 22.5 cm



41.0146.04
 no. 4L

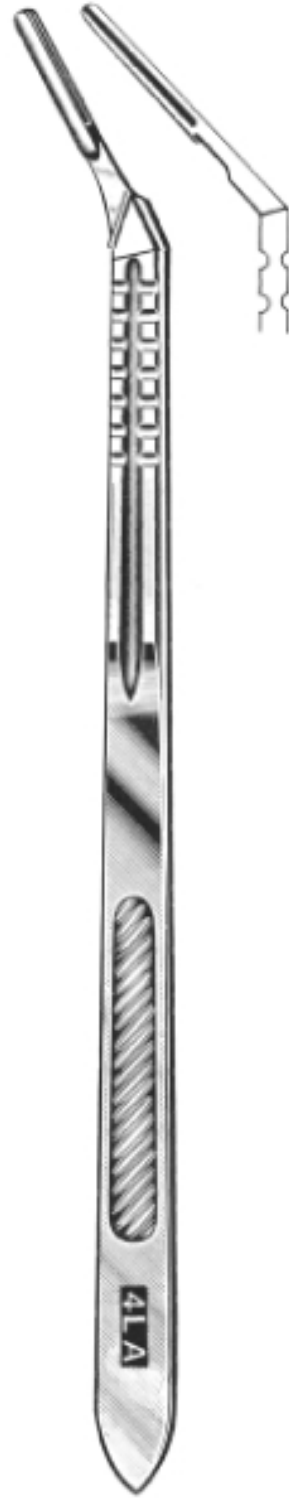

41.0145.04
 no. 4LA

41

Amputations Knives
Amputationsmesser
Cuchillos Para Amputacion



CATLIN
41.0150.23
23 cm
cutting length: 11cm
schnitt lange: 11cm
largo de corte: 11cm



COLLIN
41.0154.27 41.0158.36
27 cm 36 cm
cutting length: 15 cm cutting length: 22 cm
schnitt lange: 15 cm schnitt lange: 22 cm
largo de cone: 15 cm largo de corte: 22 cm



CATLIN
41.0162.16 41.0166.22
cutting length: 16 cm cutting length: 22 cm
schnitt lange: 16 cm schnitt lange: 22 cm
largo de corte: 16 cm largo de cone: 22 cm



41.0170.26 26 cm cutting length: 13 cm
41.0174.29 29 cm cutting length: 16 cm
41.0178.32 32 cm cutting length: 19 cm
41.0182.35 35 cm cutting length: 22 cm

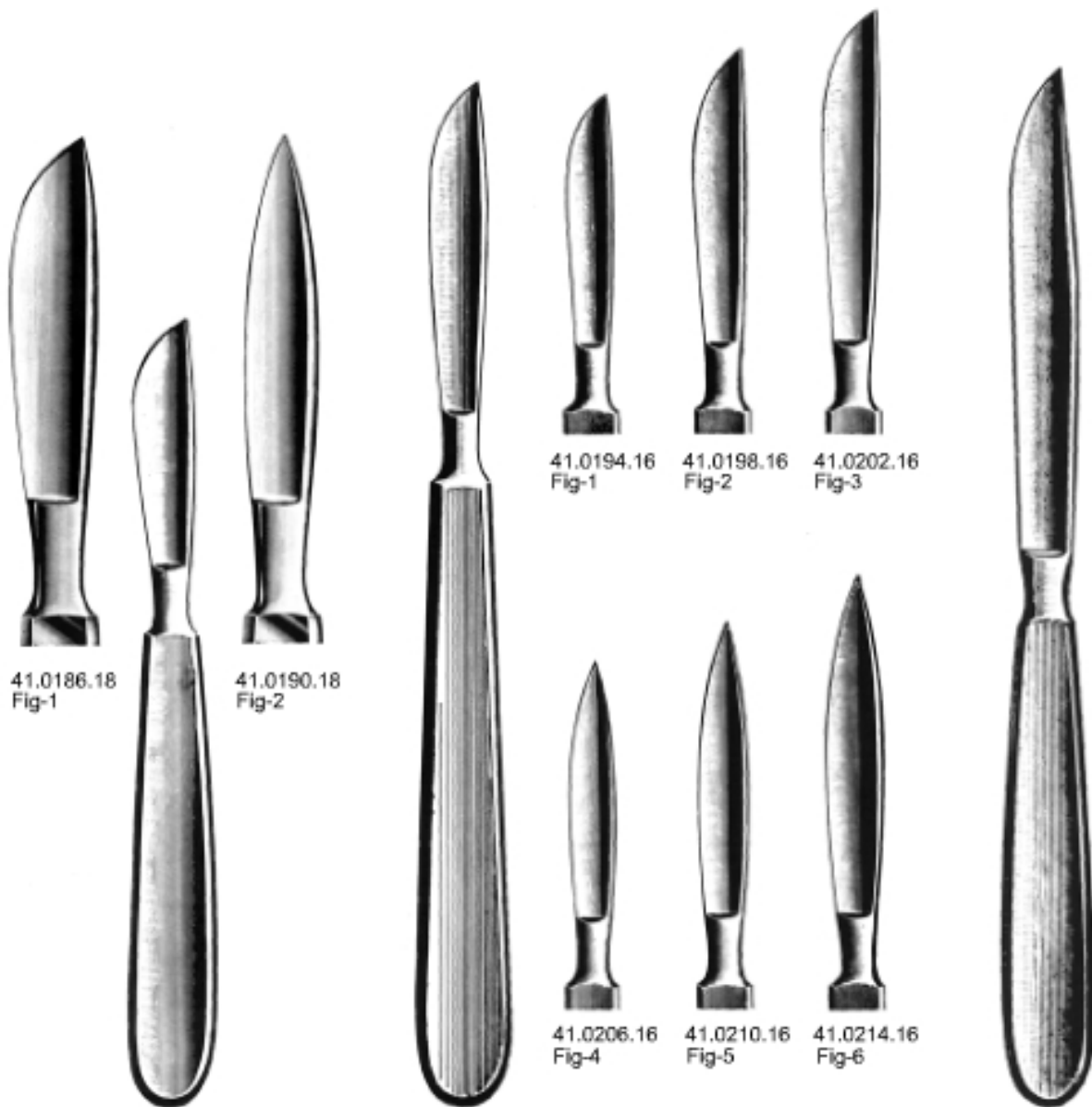

41.0186.18
Fig-1

41.0190.18
Fig-2

41.0194.16
Fig-1

41.0198.16
Fig-2

41.0202.16
Fig-3

41.0206.16
Fig-4

41.0210.16
Fig-5

41.0214.16
Fig-6

LANGENBECK
41.0186.18 - 41.0190.18
18 cm

COLLIN
41.0194.16 - 41.0214.16
16 cm

LISTON
41.0218.24
24 cm
cutting length: 10.5 cm
schnitt lange: 10.5 cm
largo de corte: 10.5 cm

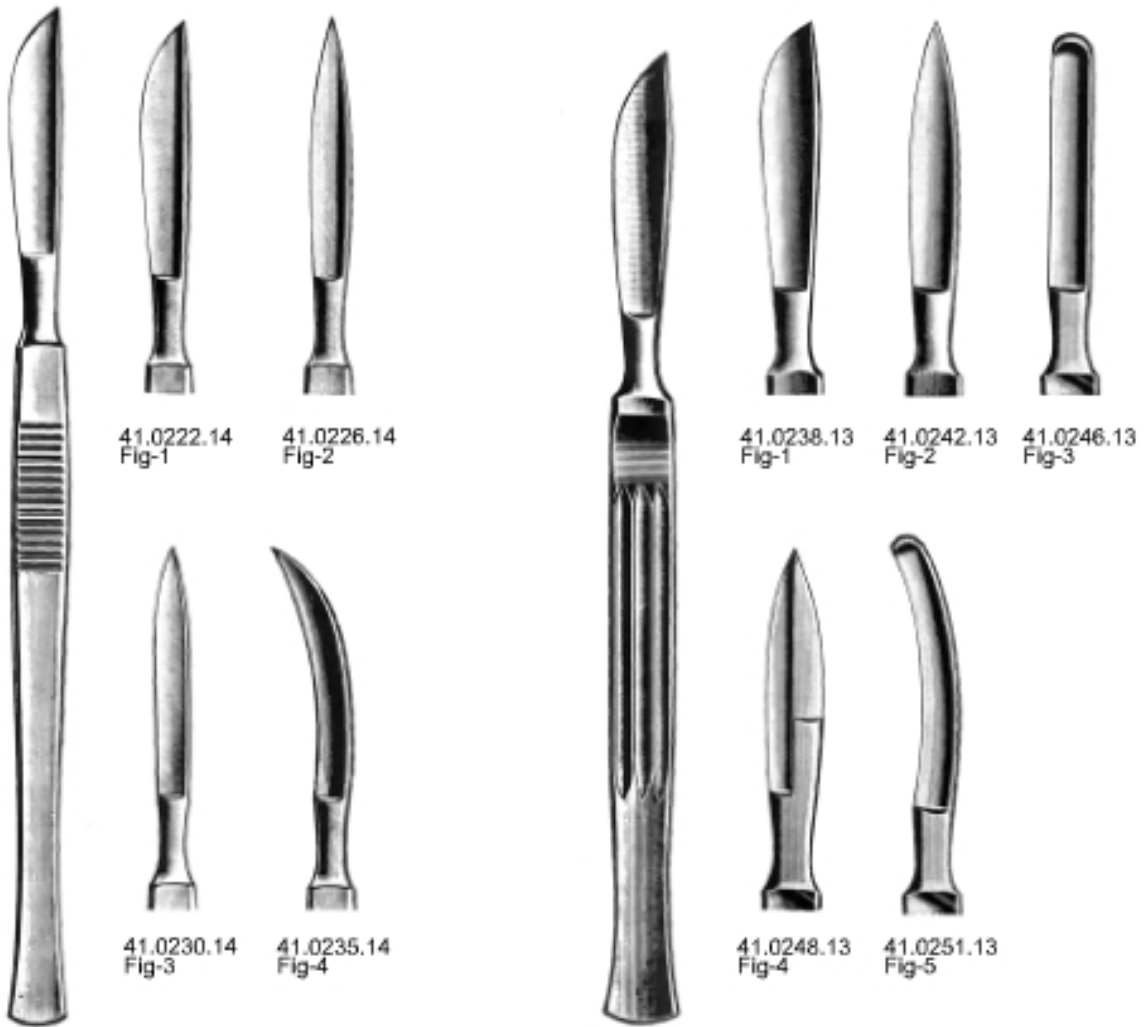

BERGMANN
41.0222.14 - 41.0235.14
14 cm

41.0238.13 - 41.0251.13
13.5 cm

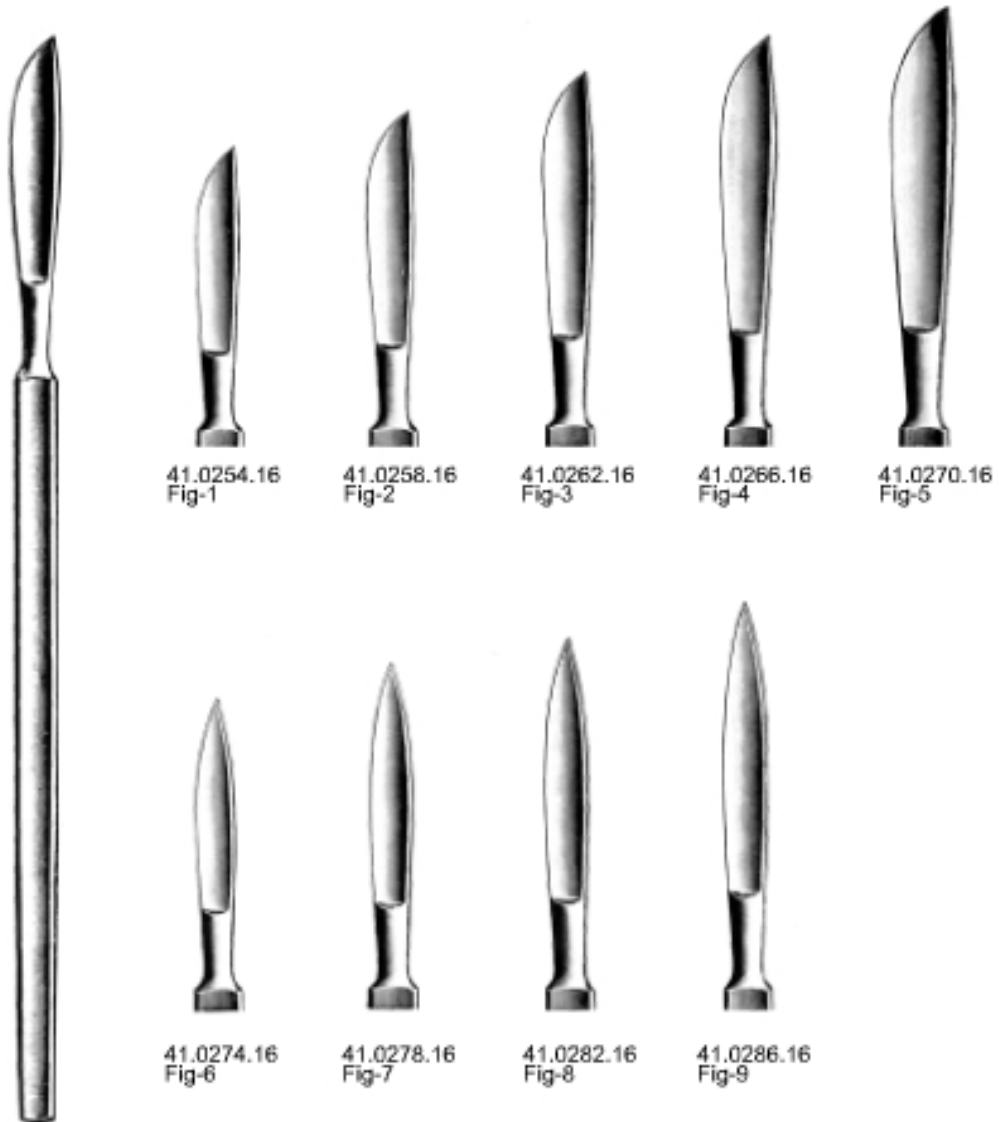

DIEFFENBACH
41.0254.16 - 41.0286.16
16 cm

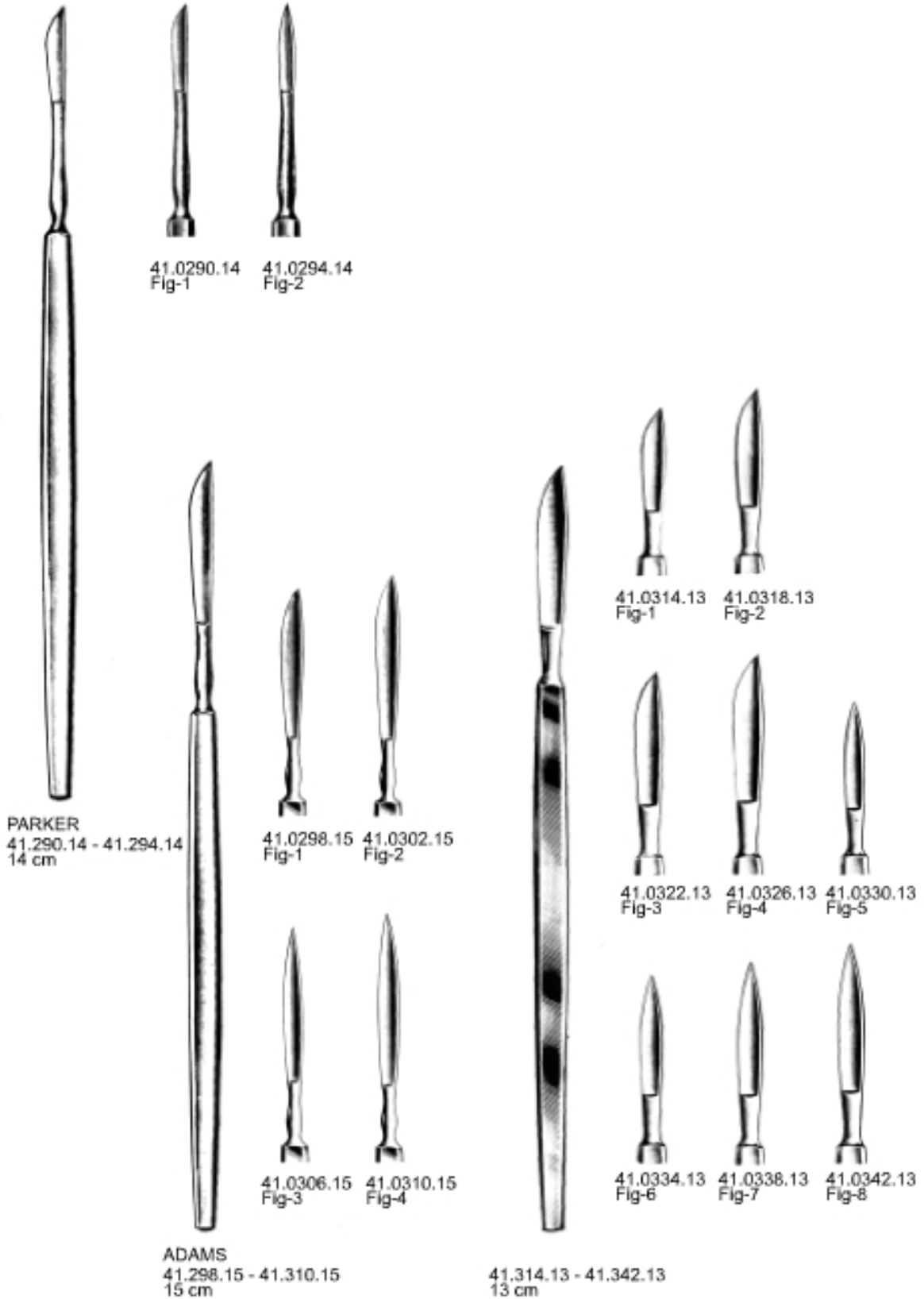



Sissors





42.0102.10 10.5 cm
42.0106.11 11 cm
42.0110.13 13 cm
42.0114.14 14.5 cm
42.0118.15 15 cm
42.0122.16 16.5 cm
42.0126.17 17.5 cm
42.0130.18 18.5 cm



42.0103.10 10.5 cm
42.0107.11 11.5 cm
42.0111.13 13 cm
42.0115.14 14.5 cm
42.0119.15 15 cm
42.0123.16 16.5 cm
42.0127.17 17.5 cm
42.0131.18 18.5 cm



42.0134.13 13 cm
42.0138.14 14.5 cm



42.0135.13 13 cm
42.0139.14 14.5 cm

Delicate Model - Schlankes Modell - Modelo Delgado



42.0142.10 10.5 cm
42.0146.11 11.5 cm
42.0150.13 13 cm
42.0154.14 14.5 cm
42.0158.15 15 cm
42.0162.16 16.5 cm
42.0166.18 18.5 cm



42.0143.10 10.5 cm
42.0147.11 11.5 cm
42.0151.13 13 cm
42.0155.14 14.5 cm
42.0159.15 15 cm
42.0163.16 16.5 cm
42.0167.18 18.5 cm



42.0170.10 10.5 cm
42.0174.11 11.5 cm
42.0178.13 13 cm
42.0182.14 14.5 cm
42.0186.15 15 cm
42.0190.16 16.5 cm
42.0194.17 17.5 cm
42.0198.18 18.5 cm



42.0171.10 10.5 cm
42.0175.11 11.5 cm
42.0179.13 13 cm
42.0183.14 14.5 cm
42.0187.15 15 cm
42.0191.16 16.5 cm
42.0195.17 17.5 cm
42.0199.18 18.5 cm

Operating Scissors
Chirurgische Scheren
Tijeras para cirugía



DOYEN
42.0202.17 - 42.0203.17
17 cm

42.0202.17

42.0203.17

Round Pattern
Rundes Modell
Modelo Redondo

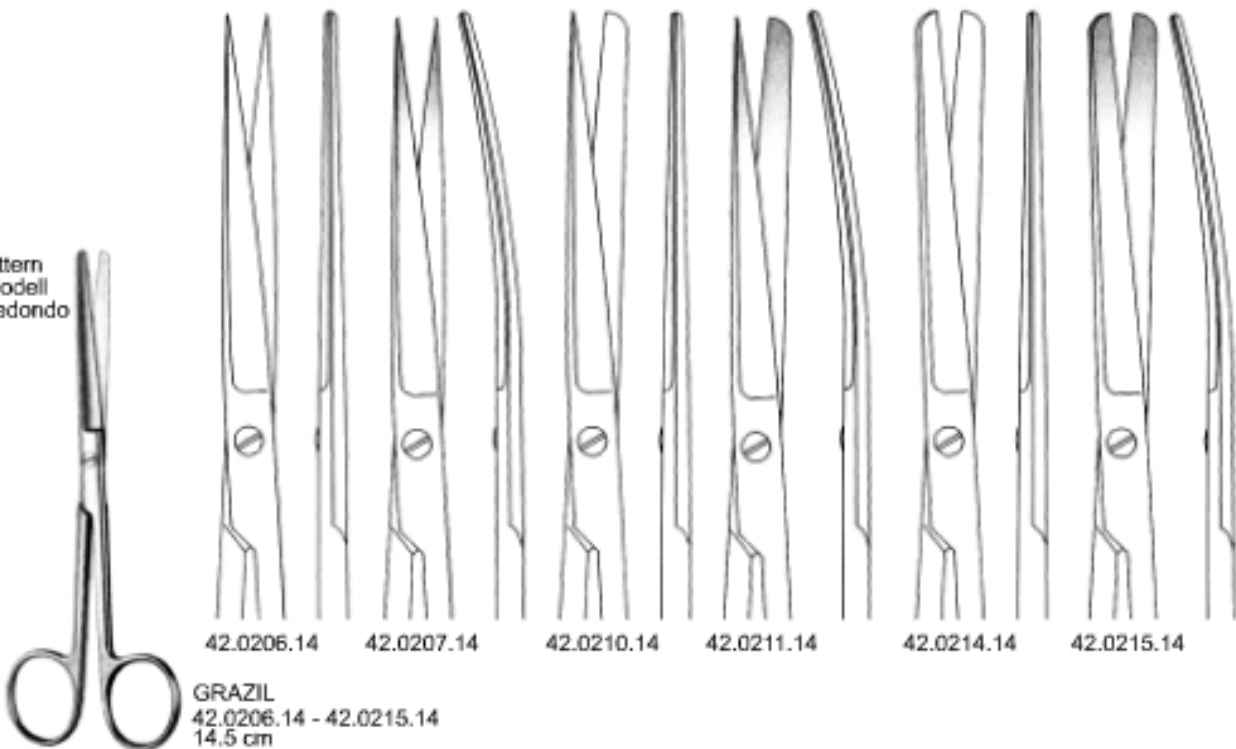

42.0206.14

42.0207.14

42.0210.14

42.0211.14

42.0214.14

42.0215.14

GRAZIL
42.0206.14 - 42.0215.14
14.5 cm

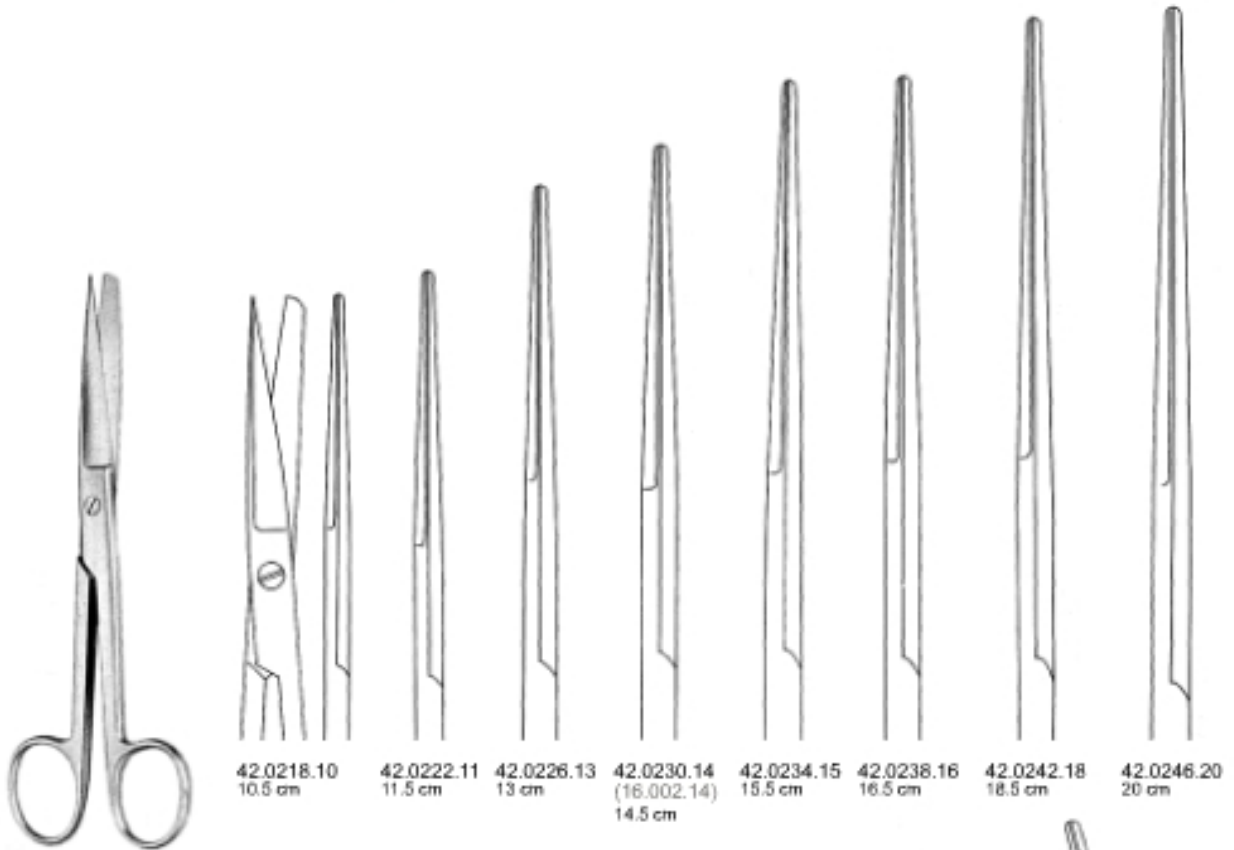

STANDARD
42.0218.10 - 42.0246.20

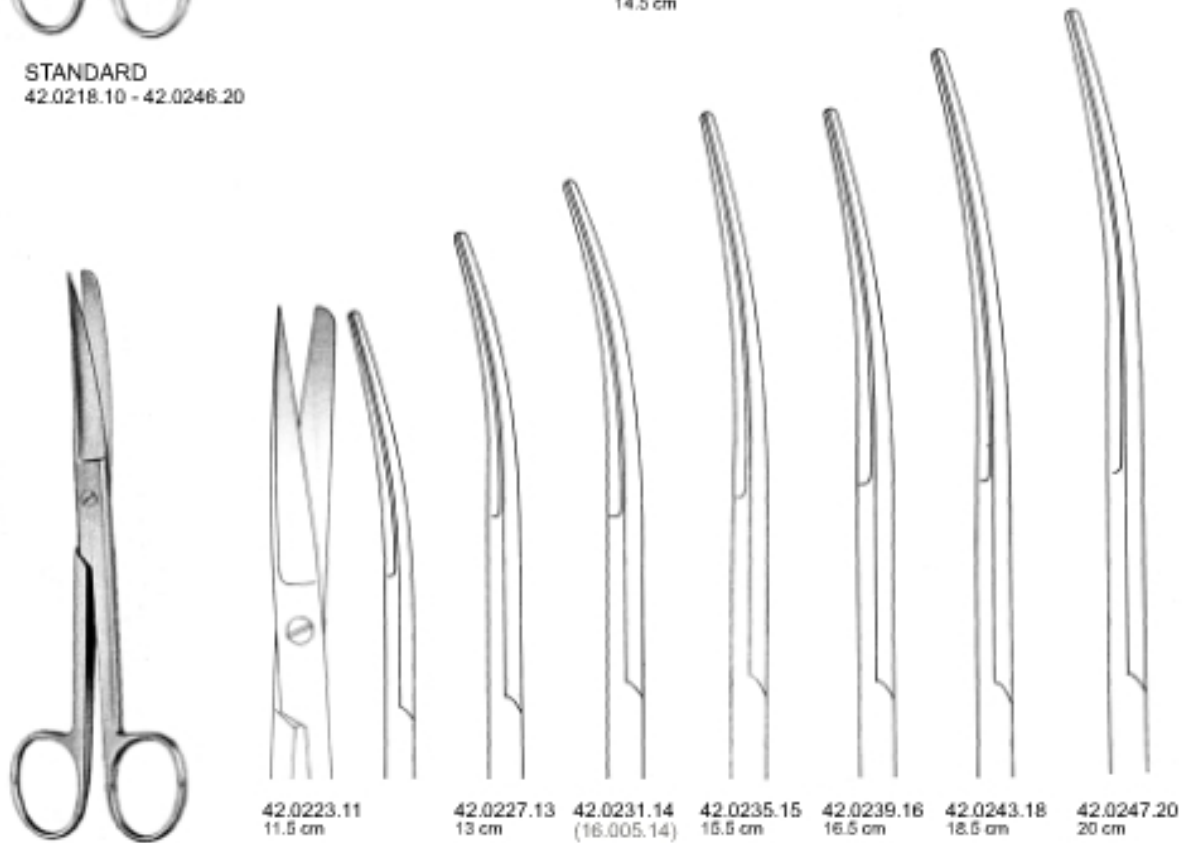

STANDARD
42.0223.11 - 42.0247.20

Operating Scissors
Chirurgische Scheren
Tijeras para cirugía

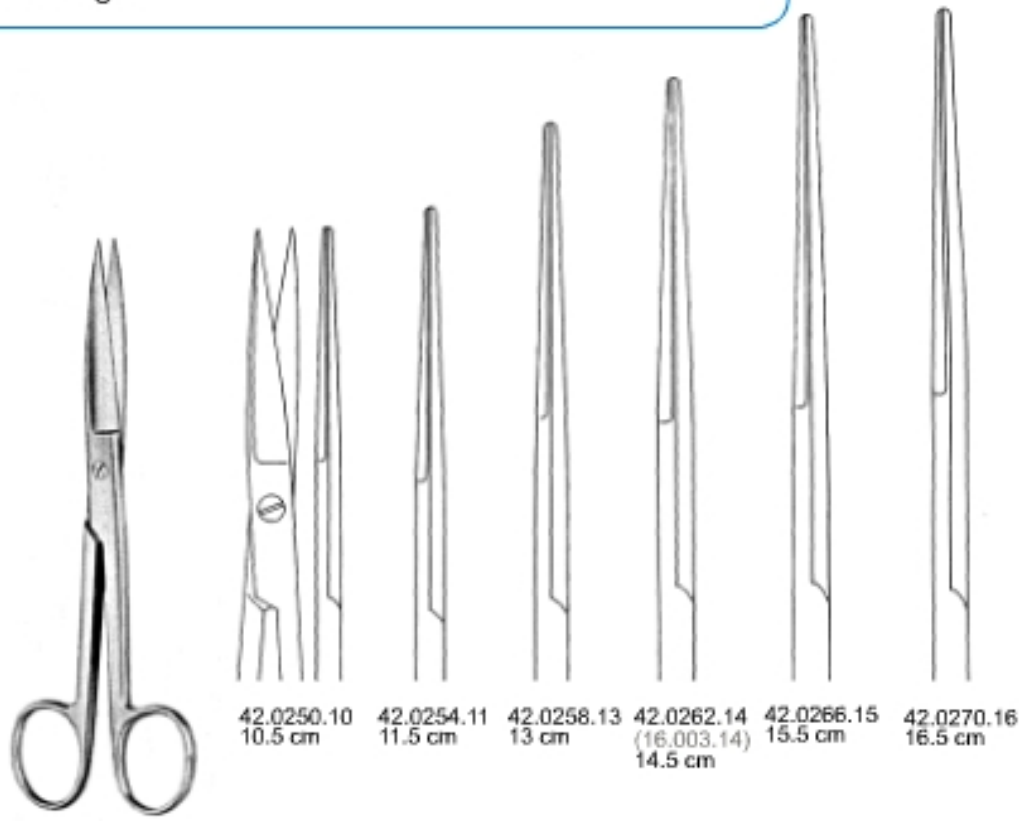

42.0250.10 10.5 cm	42.0254.11 11.5 cm	42.0258.13 13 cm	42.0262.14 (16.003.14) 14.5 cm	42.0266.15 15.5 cm	42.0270.16 16.5 cm
-----------------------	-----------------------	---------------------	--------------------------------------	-----------------------	-----------------------

STANDARD
42.0250.10 - 42.0270.16

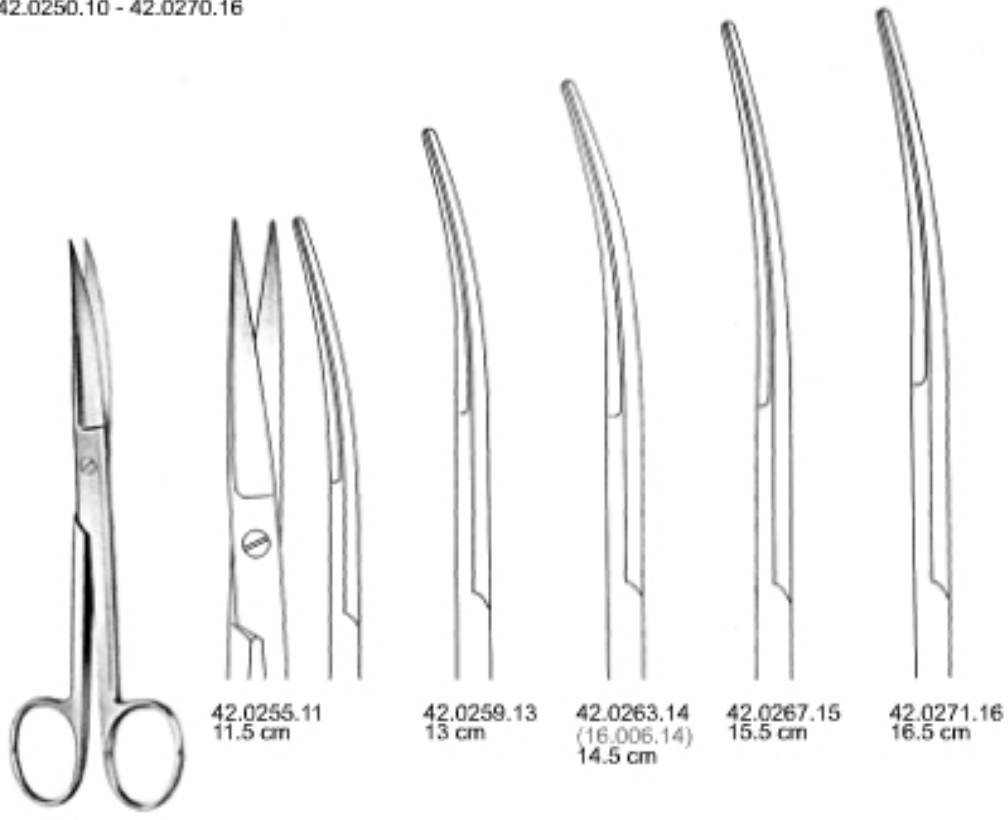

42.0255.11 11.5 cm	42.0259.13 13 cm	42.0263.14 (16.006.14) 14.5 cm	42.0267.15 15.5 cm	42.0271.16 16.5 cm
-----------------------	---------------------	--------------------------------------	-----------------------	-----------------------

STANDARD
42.0255.11 - 42.0271.16

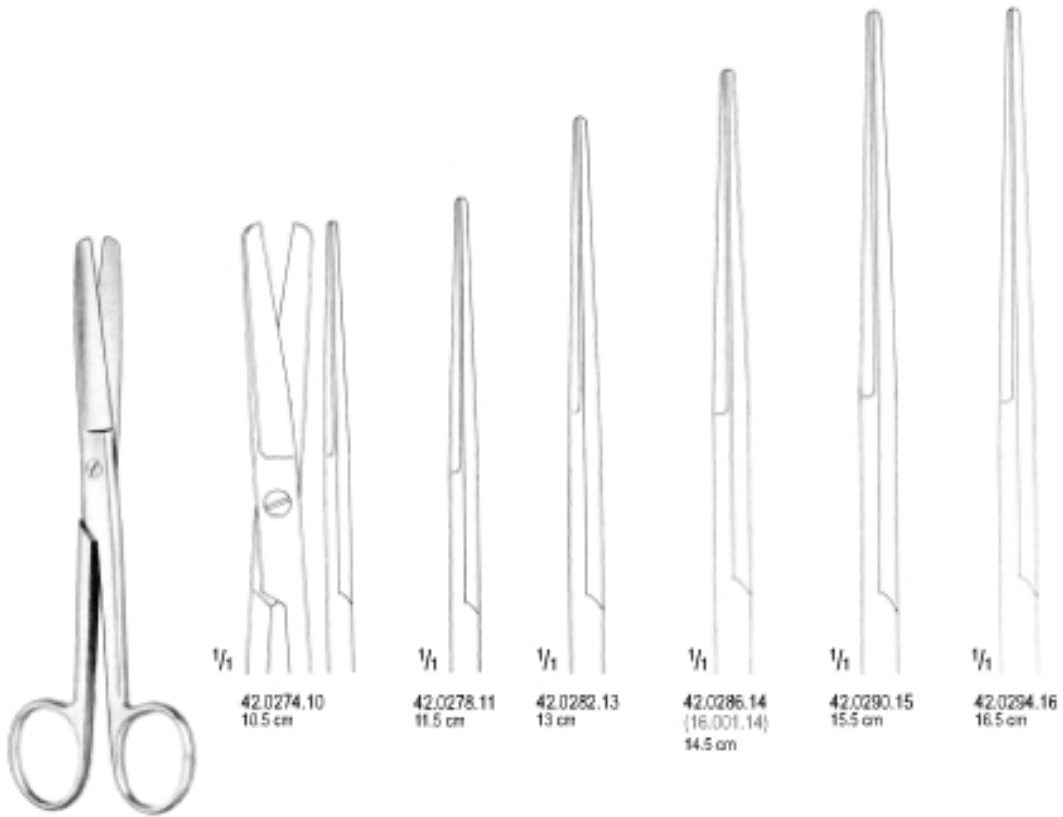

STANDARD
42.0274.10 - 42.0294.16



STANDARD
42.0279.11 - 42.0295.16

Operating Scissors
Chirurgische Scheren
Tijeras para cirugía

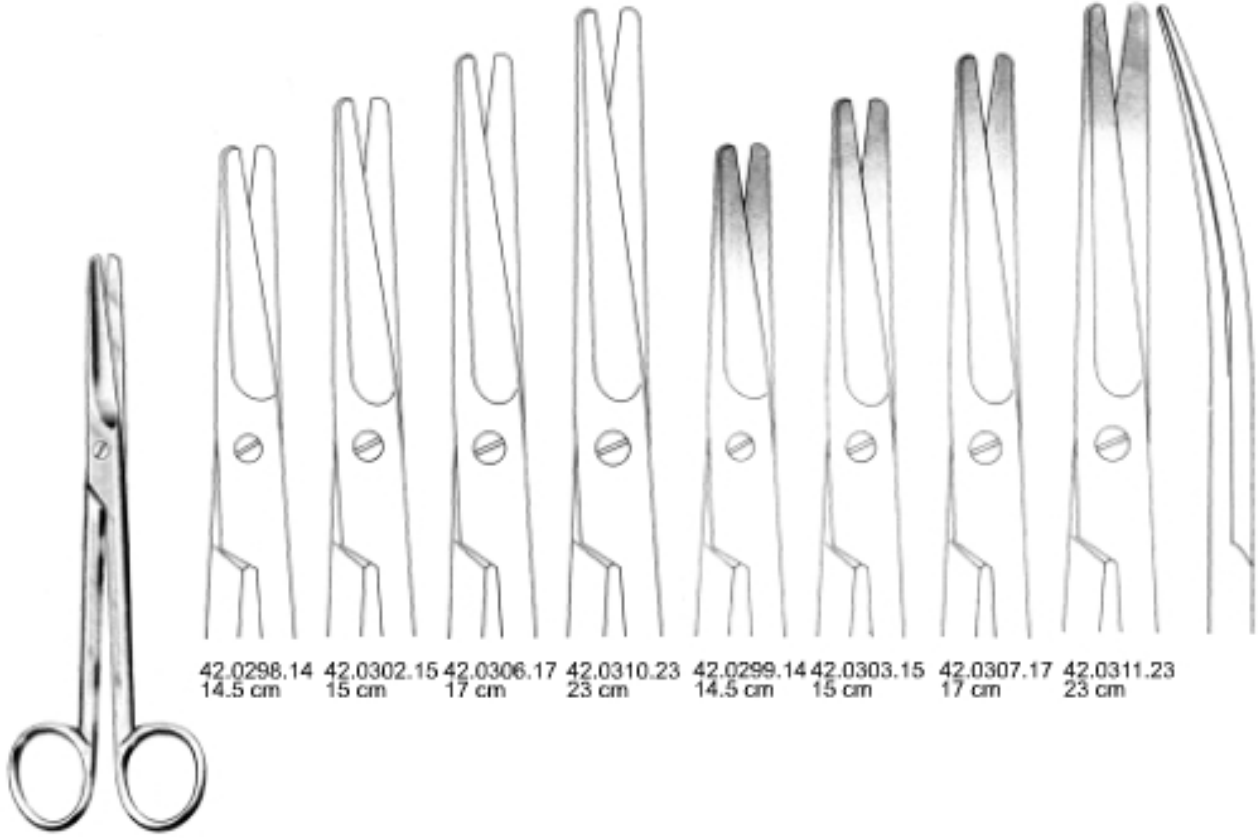

42.0298.14 14.5 cm 42.0302.15 15 cm 42.0306.17 17 cm 42.0310.23 23 cm 42.0299.14 14.5 cm 42.0303.15 15 cm 42.0307.17 17 cm 42.0311.23 23 cm

MAYO
42.0298.14 - 42.0311.23

Round Pattern
Rundes Modell
Modelo Redondo



42.0314.14 14 cm
42.0318.15 15 cm
42.0322.17 17 cm
42.0326.23 23 cm

MAYO
42.0314.14 - 42.0326.23

42.0315.14 14 cm
42.0319.15 15 cm
42.0323.17 17 cm
42.0327.23 23 cm

MAYO
42.0315.14 - 42.0327.23

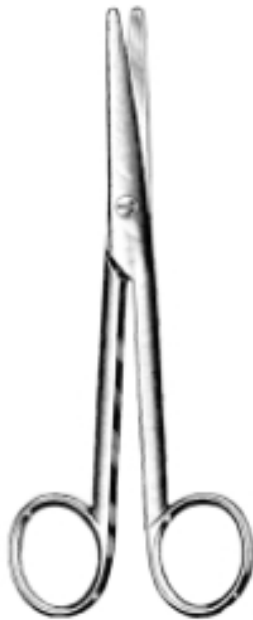

MAYO-STILLE
42.0330.15 - 42.0335.17



42.0330.15
15 cm



42.0334.17
17 cm



42.0331.15
15 cm



42.0335.17
17 cm



MAYO-STILLE
42.0338.16 - 42.0347.21



42.0338.16
16 cm



42.0342.19
19 cm



42.0346.21
21 cm



42.0339.16
16 cm



42.0343.19
19 cm



42.0347.21
21 cm

Operating Scissors
Chirurgische Scheren
Tijeras para cirugía

42



MAYO-HARRINGTON
42.350.22 - 42.0355.30



42.0350.22
22.5 cm



42.0351.22
22.5 cm



42.0355.30
30 cm

Round Pattern
Rundes Modell
Modelo Redondo



MAYO-HARRINGTON
42.0358.20 20 cm
42.0362.23 23 cm

Round Pattern
Rundes Modell
Modelo Redondo



MAYO-HARRINGTON
42.0359.20 20 cm
42.0363.23 23 cm

Round Pattern
Rundes Modell
Modelo Redondo



JÖRGENSEN
42.0367.23
23 cm



MAYO-NOBLE
42.0370.14 14 cm
42.0374.17 17 cm



MAYO-NOBLE
42.0371.14 14 cm
42.0375.17 17 cm



LISTER
42.0379.14 14 cm
42.0383.18 18 cm
42.0387.20 20 cm



INCISIONS
42.0390.13 - 42.394.14



42.0390.13
13 cm



42.0394.14
14 cm

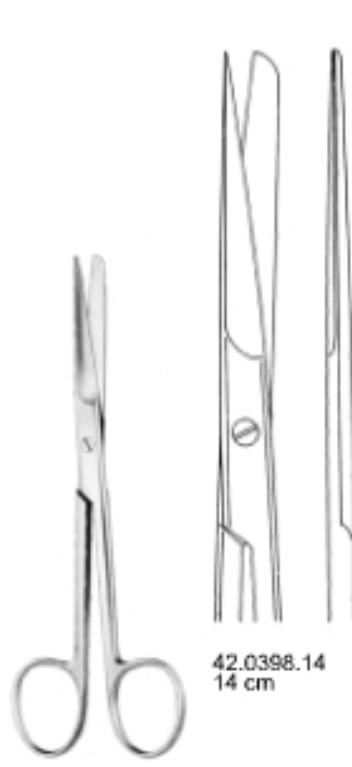

DEAVER
42.0396.14 - 42.399.14
14 cm



42.0396.14
14 cm



42.0399.14
14 cm

Dissecting Scissors
 Präparierscheren
 Tijeras para preparaciones



METZENBAUM
 42.0402.11-42.0403.11
 11.5 cm



42.0402.11
 (16.062.11)



42.0403.11
 (16.063.11)



METZENBAUM
 42.0406.15 - 42.0407.15
 15 cm



42.0406.15
 (16.065.15)



42.0407.15
 (16.065.15)



METZENBAUM
 42.0410.14 - 42.0419.14
 14.5 cm



42.0410.14
 (16.066.14)



42.0414.14
 (16.067.14)



42.0418.14
 (16.068.14)



42.0411.14
 (16.069.14)



42.0415.14
 (16.070.14)



42.0419.14
 (16.071.14)



METZENBAUM
42.0422.1818 cm
42.0426.2020 cm



METZENBAUM
42.0423.1818 cm
42.0427.2020 cm



METZENBAUM(LAHEY)
42.0430.14
14 cm



METZENBAUM(LAHEY)
42.0431.14
14 cm



METZENBAUM-FINO
42.0434.14
14.5 cm



METZENBAUM-FINO
42.0435.14
14.5 cm



METZENBAUM-FINO
42.0438.14
14.5 cm



METZENBAUM-FINO
42.0439.14
14.5 cm

Dissecting Scissors
Präparierscheren
Tijeras para preparaciones

42

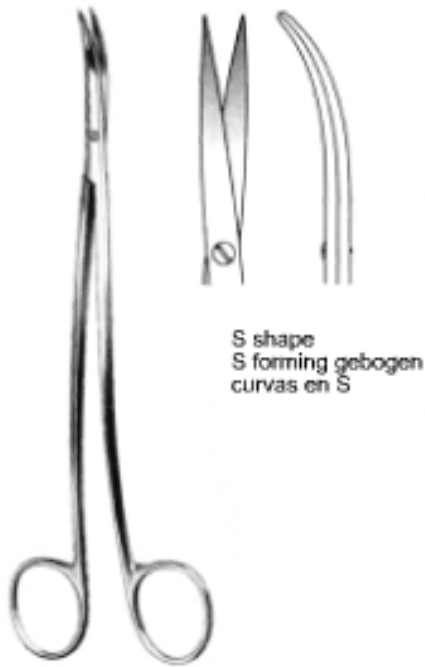

S shape
S forming gebogen
curvas en S

METZENBAUM-FINO
42.0443.18 18 cm
42.0447.20 20 cm
42.0451.23 23 cm



METZENBAUM-FINO
42.0455.18 18 cm
42.0459.20 20 cm
42.0463.23 23 cm

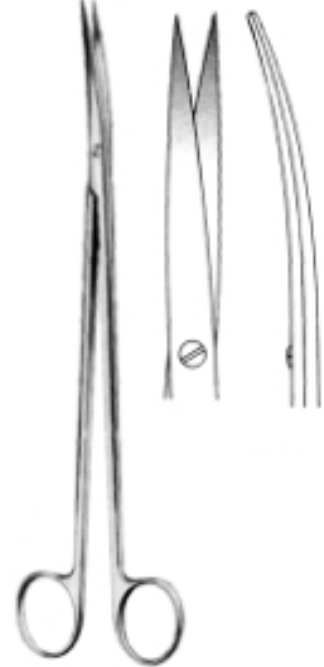

METZENBAUM-FINO
42.0467.18 18 cm
42.0471.20 20 cm
42.0475.23 23 cm

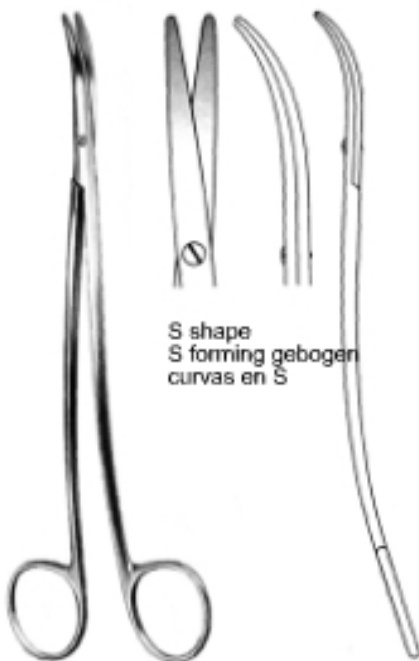

S shape
S forming gebogen
curvas en S

METZENBAUM-FINO
42.0479.18 18 cm
42.0483.20 20 cm
42.0487.23 23 cm



METZENBAUM-FINO
42.0490.18 18 cm
42.0494.20 20 cm
42.0498.23 23 cm



METZENBAUM-FINO
42.0502.18 18 cm
42.0506.20 20 cm
42.0510.23 23 cm

42

Dissecting Scissors
Präparierscheren
Tijeras para preparaciones



LEXER
42.514.16 - 42.0519.21



42.0514.16
16 cm



42.0515.16
16 cm



42.0518.21
21 cm



42.0519.21
21 cm



LEXER-FINO
42.0522.16
16 cm



LEXER-FINO
42.0523.16
16 cm



Dissecting Scissors
 Präparierscheren
 Tijeras para preparaciones



STEVENS
 42.00524.11-42.0525.11
 11 cm
 blunt - stumpf - romo



SANVENERO
 42.0528.14 - 42.0529.14
 14 cm

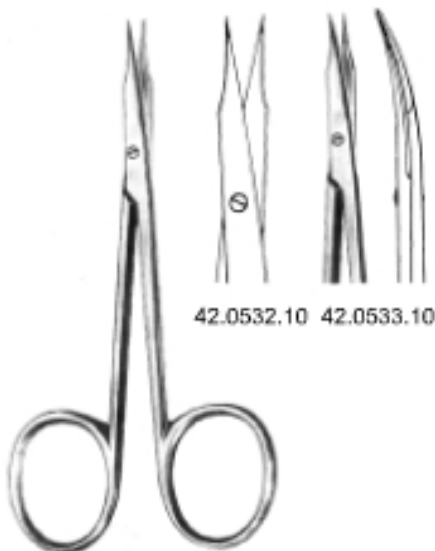

STEVENS
 42.0532.10 - 42.0533.10
 10.5 cm
 sharp - scharf - agudo

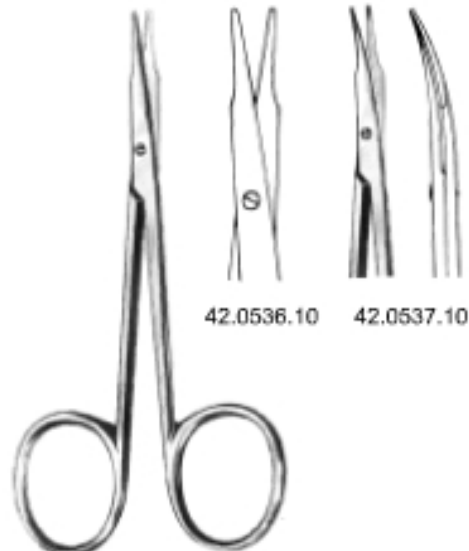

STEVENS
 42.0536.10 - 42.0537.10
 10.5 cm
 blunt - stumpf - romo

42

Dissecting Scissors
Präparierscheren
Tijeras para preparaciones



42.0558.18
18 cm



42.0562.20
20 cm



42.0566.23
23 cm



42.0570.25
25 cm



42.0574.28
28 cm



42.0578.30
30 cm

METZENBAUM-NELSON
42.0558.18 - 42.0578.30



42.0559.18
18 cm



42.0563.20
20 cm



42.0567.23
23 cm



42.0571.25
25 cm



42.0575.28
28 cm



42.0579.30
30 cm

METZENBAUM-NELSON
42.0559.18 - 42.0579.30

Dissecting Scissors
 Präparierscheren
 Tijeras para preparaciones



METZENBAUM-NELSON
 42.0582.18 - 42.0602.30



42.0582.18
 18 cm



42.0586.20
 20 cm



42.0590.23
 23 cm



42.0594.25
 25 cm



42.0598.28
 28 cm



42.0602.30
 30 cm



METZENBAUM-NELSON
 42.0583.18 - 42.0603.30



42.0583.18
 18 cm



42.0587.20
 20 cm



42.0591.23
 23 cm



42.0595.25
 25 cm



42.0599.28
 28 cm



42.0603.30
 30 cm

42

Dissecting Scissors
Präparierscheren
Tijeras para preparaciones

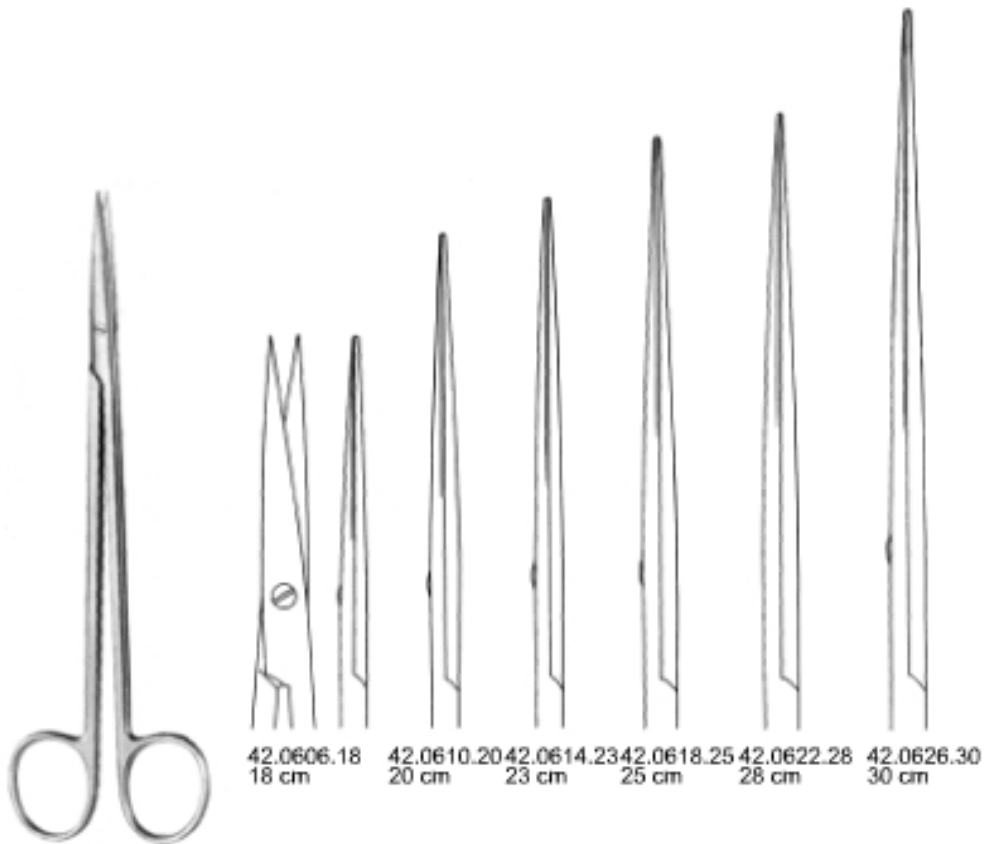

METZENBAUM-NELSON
42.0606.18 - 42.0626.30



METZENBAUM-NELSON
42.0607.18 - 42.0627.30

▶ 036

Dissecting Scissors
 Präparierscheren
 Tijeras para preparaciones

42



SIMS
 42.0632.20 - 42.0637.23



42.0632.20
 20 cm



42.0633.20
 20 cm



42.0636.23
 23 cm



42.0637.23
 23 cm

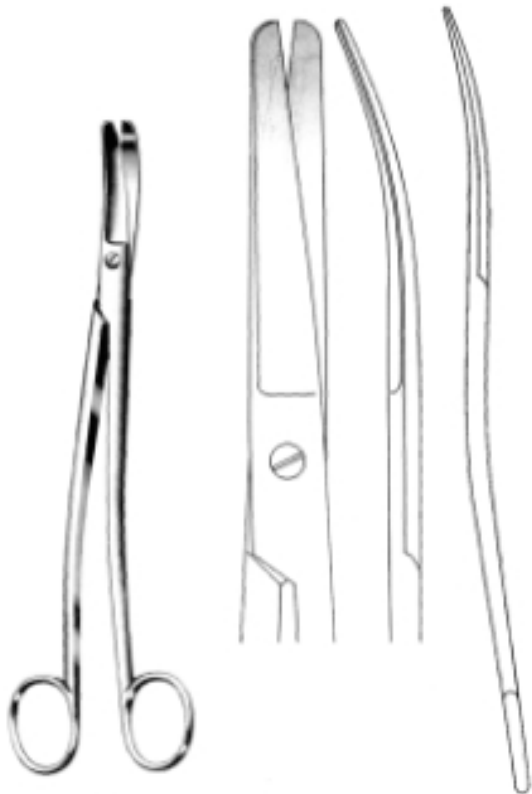

SIEBOLD
 42.0641.24
 24 cm



NERVE
 42.0644.15 - 42.0645.15
 15 cm



42.0644.15



42.0645.15



42.0648.14

42.0649.14

DISSECTING SCISSOR
with outside cutting edge
42.0648.14 - 42.0649.14
14.5 cm

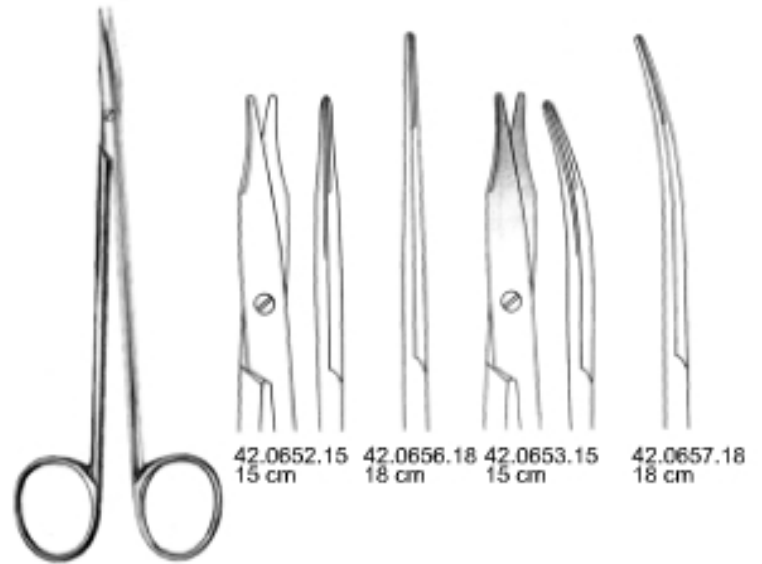

42.0652.15
15 cm

42.0656.18
18 cm

42.0653.15
15 cm

42.0657.18
18 cm

REYNOLDS
42.0652.15 - 42.0657.18

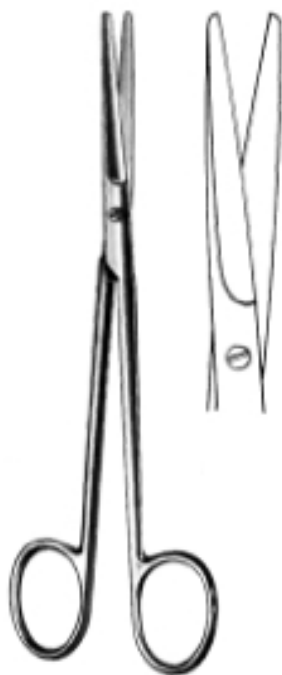

MIXER
42.0660.15
15 cm



MIXER
42.0661.15
15 cm



FOMON
42.0665.14
13.5 cm

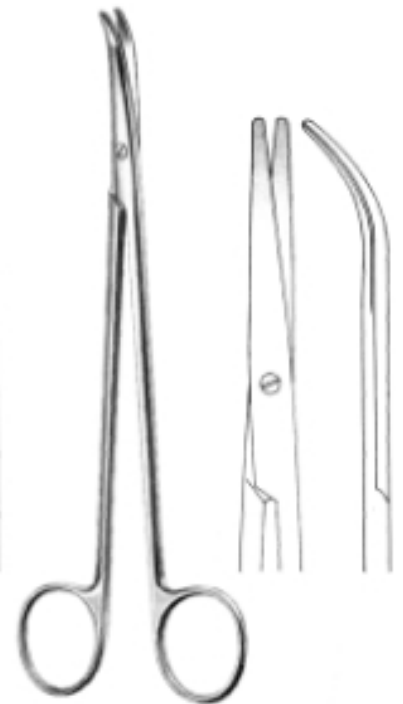

THOREK
42.0669.19
19 cm

Dissecting Scissors
 Präparierscheren
 Tijeras para preparaciones

42



GOLDMAN FOX
 42.0672.13
 13 cm
 (16.302.13)
 1 blade saw edge
 1 schneide gezahnt
 1 hoja dentada



GOLDMAN FOX
 42.0673.13
 13 cm
 (16.303.13)
 1 blade saw edge
 1 schneide gezahnt
 1 hoja dentada



QUINBY
 42.0676.13
 13 cm



QUINBY
 42.0677.13
 13 cm



LOCKLIN
 42.0681.16
 16 cm
 (16.180.16)



IRIS-MICRO
42.0700.09
09 cm



IRIS-MICRO
42.0701.09
09 cm



IRIS-SELECT
42.0704.10
10.5 cm



IRIS-SELECT
42.0705.10
10.5 cm

Dissecting Scissors
Präparierscheren
Tijeras para preparaciones

42



42.0713.10
10.5 cm



42.0717.12
12 cm



42.0720.12
12 cm



42.0721.12
12 cm

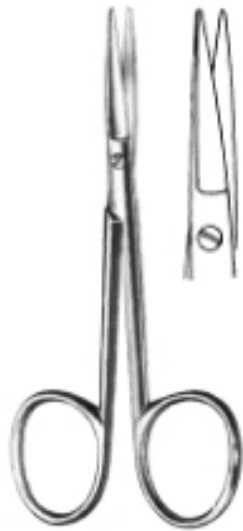

42.0724.10
10.5 cm



42.0725.10
10 cm

42.0729.12
12 cm

42.0725.10 - 42.0729.12



42.0733.12
12 cm

Dissecting Scissors
 Präparierscheren
 Tijeras para preparaciones

42



42.0736.11
11.5 cm

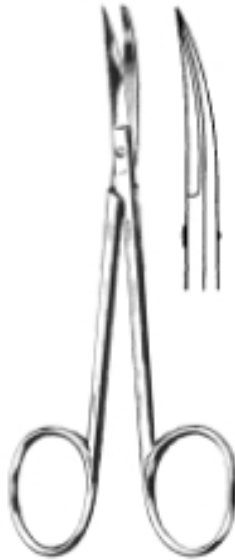

42.0737.11
11.5 cm

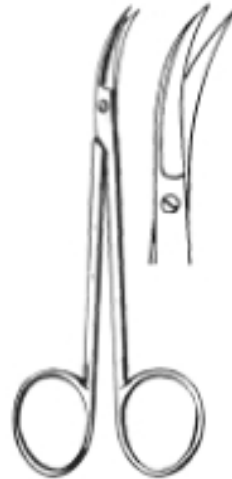

WALKER
42.0741.10
10 cm

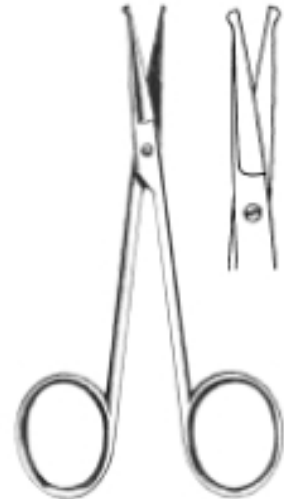

42.0744.10
10.5 cm



42.0748.12
12 cm



42.0749.12
12 cm



GRAEFE
42.0753.10
10.5 cm



42.0757.11
11.5 cm



42.0760.10
10.5 cm



42.0761.10
10.5 cm



42.0764.09 9 cm
42.0768.10 10.5 cm
42.0772.11 11.5 cm
42.0776.12 12.5 cm



42.0765.09 9 cm
42.0769.10 10.5 cm
42.0773.11 11.5 cm
42.0777.12 12.5 cm



42.0780.09 9 cm
42.0784.10 10.5 cm



42.0781.09 9 cm
42.0785.10 10.5 cm



42.0788.11
11 cm



42.0789.11
11 cm

Dissecting Scissors
 Präparierscheren
 Tijeras para preparaciones

42



WAGNER
 42.0792.12
 12 cm



WAGNER
 42.0793.12
 12 cm



WAGNER
 42.0796.12
 12 cm



WAGNER
 42.0797.12
 12 cm



WAGNER
 42.0800.12
 12 cm



WAGNER
 42.0801.12
 12 cm



JOSEPH
42.0804.14 - 42.0805.14
14 cm



KILNER
42.0808.12 - 42.809.15



REYNOLDS (JAMESSON)
42.0812.1212 cmsharp-scharf-agudo
42.0816.1414 cmsharp-scharf-agudo



REYNOLDS (JAMESSON)
42.0813.12 12 cmblunt-stumpf-romo
42.0817.14 14 cmblunt-stumpf-romo

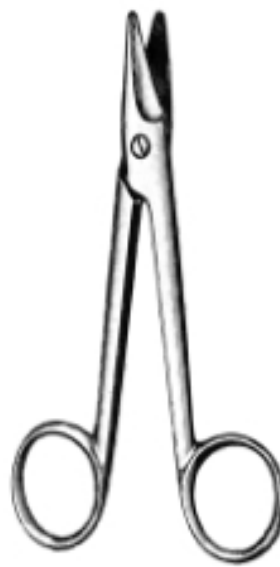

SISTRUNK
42.0822.14
14 cm

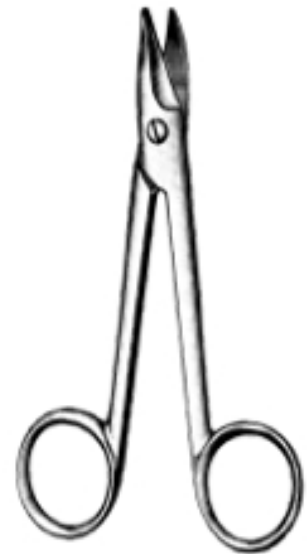

SISTRUNK (curved-gebogen-curved)
42.0823.14
14 cm

Dissecting Scissors
 Präparierscheren
 Tijeras para preparaciones

42



DE MARTEL
 42.0826.18
 18 cm
 blunt-stumpf-romo



DE MARTEL
 42.0827.18
 18 cm
 blunt-stumpf-romo



DE MARTEL
 42.0830.18
 18 cm
 sharp-scharf-agudo



DE MARTEL
 42.0831.18
 18 cm
 sharp-scharf-agudo



42.0832.13 13 cm
 42.0836.14 14.5 cm



42.0833.13 13 cm
 42.0837.14 14.5 cm



42.0840.13 13 cm
 42.0844.14 14.5 cm



42.0841.13 13 cm
 42.0845.14 14.5 cm

42

Dissecting Scissors
Präparierscheren
Tijeras para preparaciones

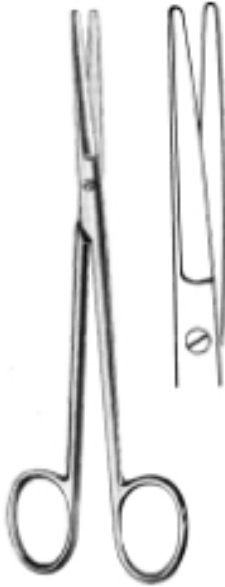

WERTHEIM
42.0846.14
14.5 cm



WERTHEIM
42.0847.14
14.5 cm



WERTHEIM
42.0848.2020 cm
42.0852.2323 cm



KNAPP sharp-scharf-agudo
42.0856.12
12 cm



KNAPP blunt-stumpf-romo
42.0860.12
12 cm



KNAPP sharp-scharf-agudo
42.0857.12
12 cm



KNAPP blunt-stumpf-romo
42.0861.12
12 cm

Dissecting Scissors
Präparierscheren
Tijeras para preparaciones

42



SATINSKY
42.0865.18
18 cm



KLINKENBERGH
42.0869.23
23 cm



HOUSE-TOENNIS
42.0872.18
18 cm



TOENNIS
42.0873.18
18 cm



RICHTER
42.0877.14
14 cm



FERGUSON
42.0881.16
16.5 cm



NAIL SPLITTING
42.0884.13 13 cm
42.0888.15 15 cm



42.0892.26

42.0893.26



CHURCH
 42.0892.26 - 42.0893.26
 25.5 cm



42.0900.26

42.0901.26

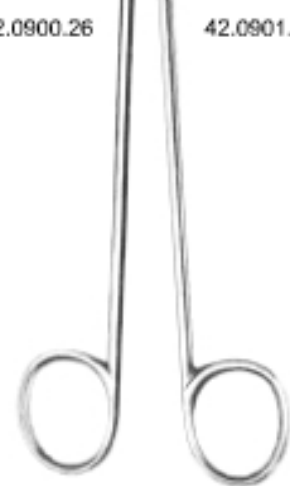

DUFFIELD
 42.0900.26 - 42.0901.26
 25.5 cm



42.0896.26

42.0897.26



LINCOLN
 42.0896.26 - 42.0897.26
 25.5 cm

Ligature Scissors
Ligituschen
Tijeras para ligaduras

42

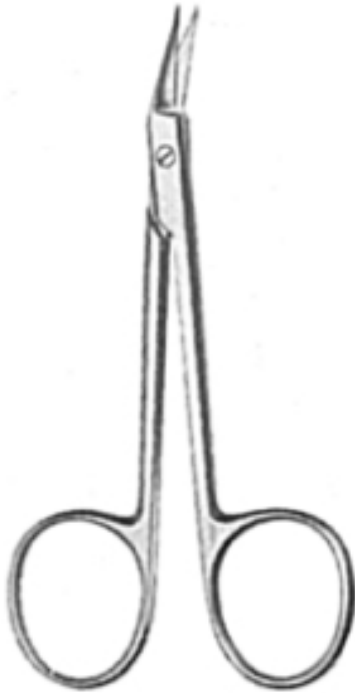

42.0905.09
16-010-09
9.5 cm
O'Brien



42.0909.12
16-009-12
12.5 cm
Northbent



42.0913.09
16-008-09
9 cm
Shortbent



42.0916.09 16-007-09 (9cm)
42.0920.10 16-007-10 (10.5cm)
42.0924.13 16-007-13 (13cm)
Spencer

051 ◀

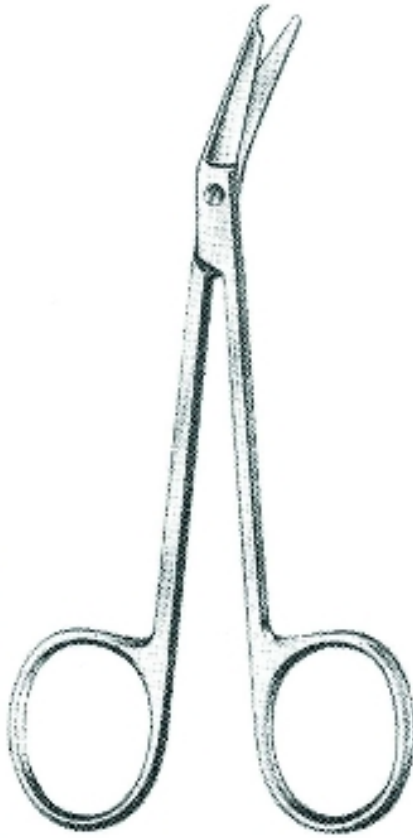

42.0927.11
16.011.11
11.5 cm

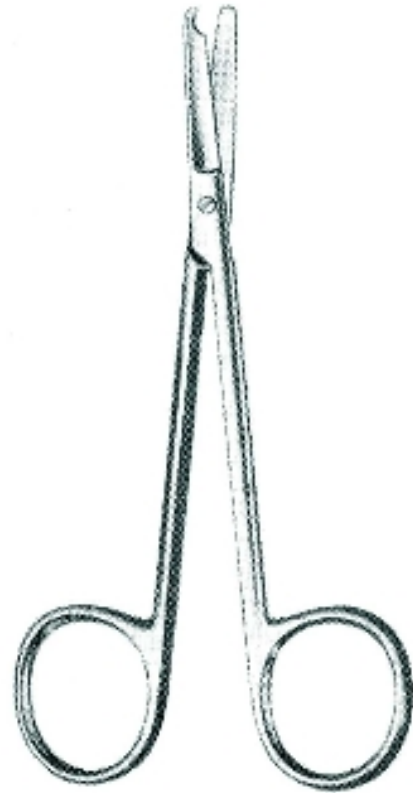

SPENCER-DELICATE
42.0932.11
11.0 cm

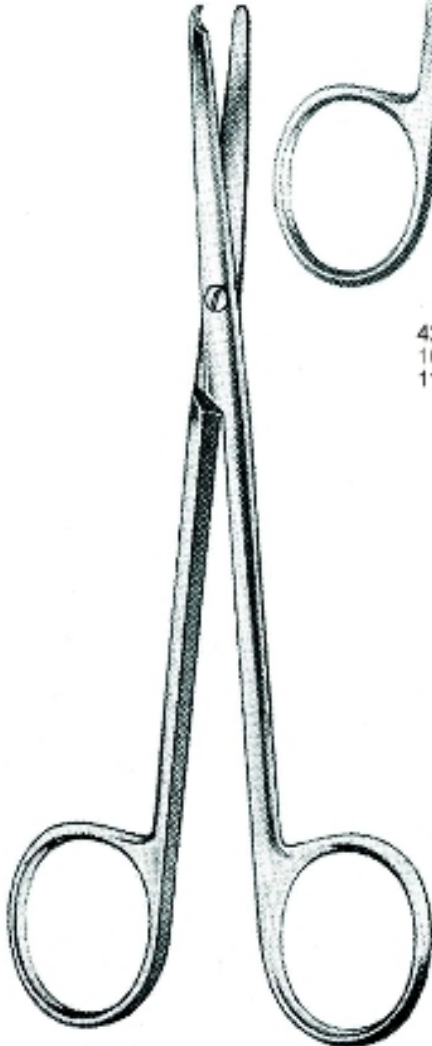

BUCK
42.0936.14 14.5 cm
42.0940.18 18.0 cm

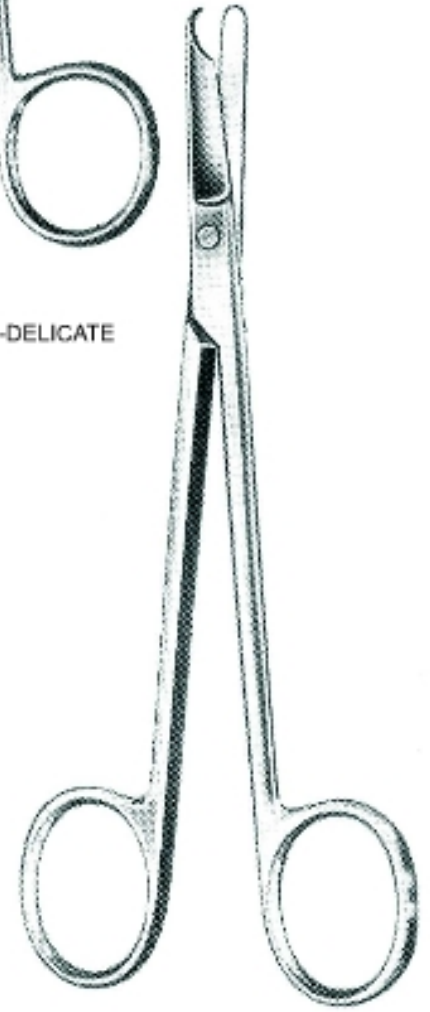

LITTAUER
42.0944.14
14.0 cm

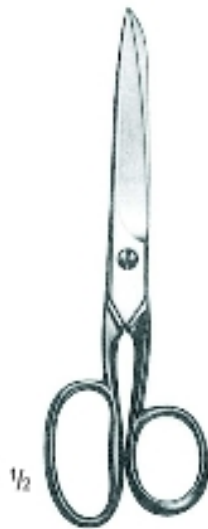

42.0948.18
32-120-18
18 cm
SMITH



42.0952.20 32-121-20 (20 cm)
42.0956.25 32-122-25 (25 cm)
PAPER

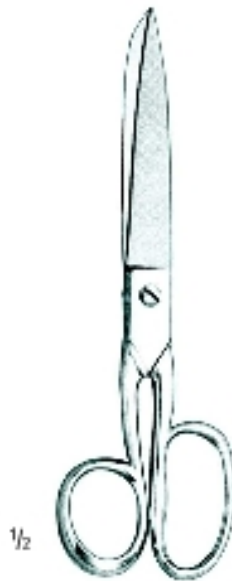

42.0960.18
32-123-18
18 cm
SMITH

42

Bandage Scissors
Verbandscheren
Tijeras para Vedajes



42.0964.13 32.124.13 (13 cm)
42.0968.16 32.125.16 (16 cm)



42.0972.13
32.126.13
13 cm



SCHO
OL
42.097
6.11
32.127.
11
11 cm



SCHOOL
42.0980.12
32.127.12
12 cm

Dissecting Scissors with Tungsten Carbide Inserts
 Präparierscheren mit Hartmetalleinsätzen
 Tijeras para preparaciones con bocas de carburo de Tungsteno

TC GOLD



42.0984.14
14.5 cm



42.0988.14
14.5 cm



42.0992.14
14.5 cm



42.0996.14
14.5 cm



42.1000.14
14.5 cm

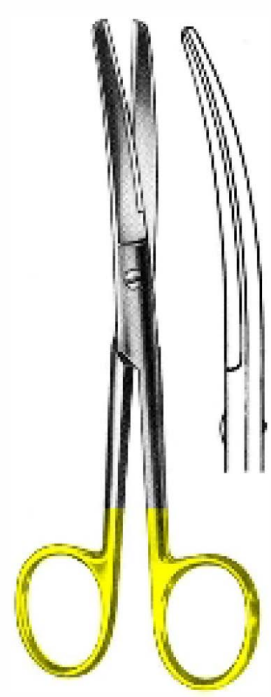

42.1004.14
14.5 cm

42

Dissecting Scissors with Tungsten Carbide Inserts
 Präparierscheren mit Hartmetalleinsätzen
 Tijeras para preparaciones con bocas de carburo de Tungsteno

TC GOLD



MAYO-HARRINGTON
 42.1008.20 20 cm
 42.1012.23 23 cm

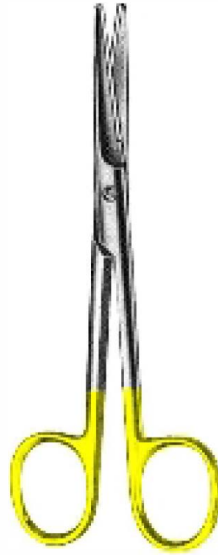

MAYO
 42.1016.14 14 cm
 42.1020.17 17 cm



MAYO
 42.1023.14 14 cm
 42.1027.17 17 cm

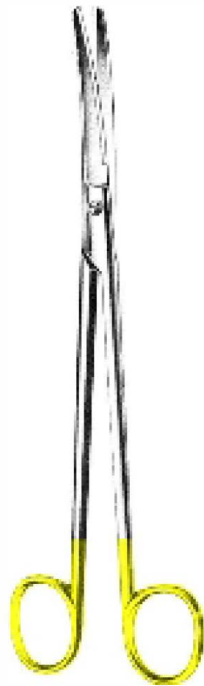

MAYO-HARRINGTON
 42.1031.20 20 cm
 42.1035.23 23 cm

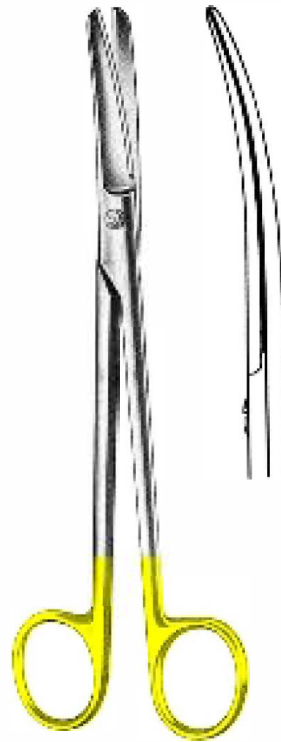

SIMS
 42.1039.20 20 cm
 42.1043.23 23 cm

Dissecting Scissors with Tungsten Carbide Inserts
 Präparierscheren mit Hartmetalleinsätzen
 Tijeras para preparaciones con bocas de carburo de Tungsteno

TC GOLD

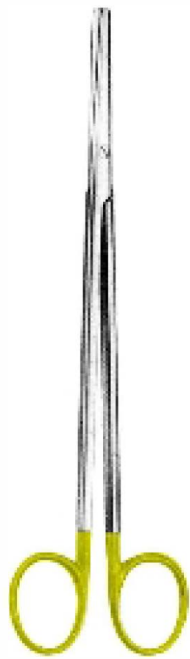

METZENBAUM
 42.1048.18-42.1068.30



42.1048.18
 18 cm



42.1052.20
 20 cm



42.1056.23
 23 cm



42.1060.25
 25 cm



42.1064.28
 28 cm



42.1068.30
 30 cm



METZENBAUM
 42.1071.18-42.1091.30



42.1071.18
 18 cm



42.1075.20
 20 cm



42.1079.23
 23 cm



42.1083.25
 25 cm



42.1087.28
 28 cm



42.1091.30
 30 cm

42

Dissecting Scissors with Tungsten Carbide Inserts
 Präparierscheren mit Hartmetalleinsätzen
 Tijeras para preparaciones con bocas de carburo de Tungsteno

TC GOLD



METZENBAUM FINO
 42.1094.23 - 42.1106.14



42.1094.23
 23 cm



42.1098.20
 20 cm



42.1102.18
 18 cm



42.1106.14
 14 cm



METZENBAUM FINO
 42.1109.23 - 42.1121.14



42.1109.23
 23 cm



42.1113.20
 20 cm



42.1117.18
 18 cm



42.1121.14
 14 cm

Dissecting Scissors with Tungsten Carbide Inserts
 Präparierscheren mit Hartmetalleinsätzen
 Tijeras para preparaciones con bocas de carburo de Tungsteno

TC GOLD

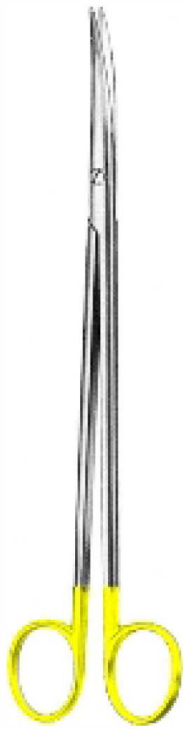

METZENBAUM
 42.1125.20 - 42.1129.23



42.1125.20
 20 cm



42.1129.23
 23 cm



METZENBAUM-LAHEY
 42.1133.14
 14 cm



TOENNIS-ADSON
 42.1137.17
 17 cm

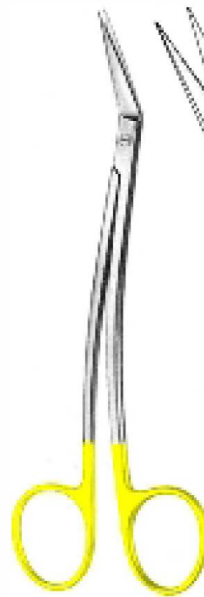

LOCKLIN
 42.1141.16
 16 cm



LOCKLIN
 42.1145.16
 16 cm

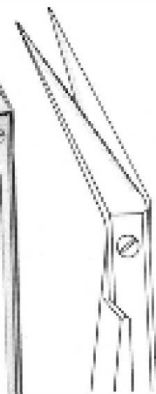

42

Dissecting Scissors with Tungsten Carbide Inserts
 Präparierscheren mit Hartmetalleinsätzen
 Tijeras para preparaciones con bocas de carburo de Tungsteno

TC GOLD



42.1148.16
16 cm



42.1152.21
21 cm

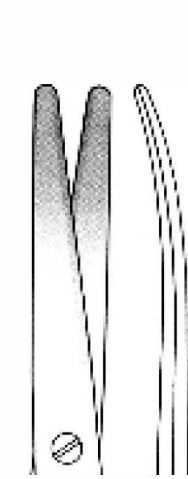
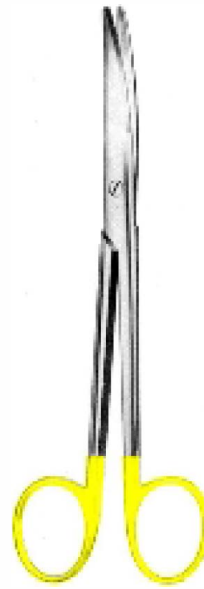

42.1157.16
16 cm



42.1161.21
21 cm

LEXER
42.1148.16 - 42.1152.21

LEXER
42.1157.16 - 42.1161.21

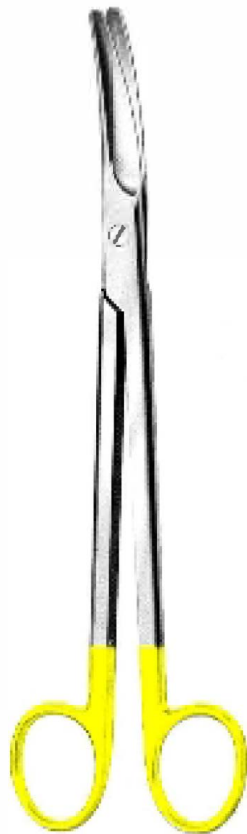

42.1165.23
23 cm



42.1169.22
22.5 cm

PARAMETRIUM
42.1165.23 - 42.1169.22

Dissecting Scissors with Tungsten Carbide Inserts
 Präparierscheren mit Hartmetalleinsätzen
 Tijeras para preparaciones con bocas de carburo de Tungsteno

TC GOLD



KELLY
 42.1174.16-42.1179.16
 16 cm



1/4
 42.1174.16
 (16.124.16)



1/4
 42.1179.16
 (16.123.16)

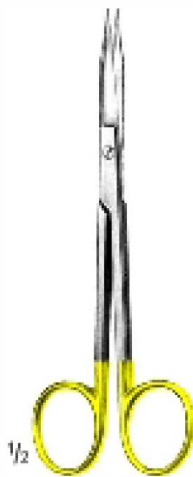

GOLDMAN FOX
 42.1184.13
 (16.121.13)
 13 cm



1/4



GOLDMAN FOX
 42.1187.13
 (16.122.13)
 13 cm



1/4

42

Dissecting Scissors with Tungsten Carbide Inserts
 Präparierscheren mit Hartmetalleinsätzen
 Tijeras para preparaciones con bocas de carburo de Tungsteno

TC GOLD

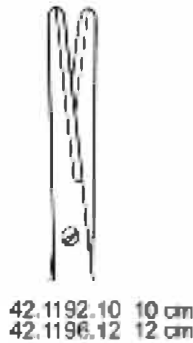

42.1192.10 10 cm
 42.1196.12 12 cm

LEXER-BABY
 42.1192.10 - 42.1196.12



42.1199.10 10 cm
 42.1203.12 12 cm

LEXER-BABY
 42.1199.10 - 42.1203.12

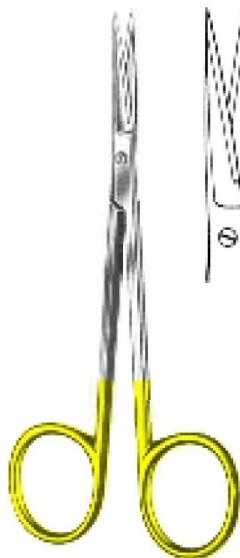

IRIS
 42.1208.11
 (16.126.11)
 11.5 cm



IRIS
 42.1213.11
 (16.127.11)
 11.5 cm

Scissors-Micro **Super Cut**
 Scheren-Micro-**Schliff**
 Tijeras **Super Cortes** Con Micropulido



STILE SUPER CUT
 42.1218.10 straight sharp 10 cm
 42.1221.10 curved sharp 10 cm



JABALEY-STILLE SUPER CUT
 42.1224.12 straight sharp 12 cm
 42.1229.12 curved sharp 12 cm



STEVENS SUPER CUT
 42.1234.12 straight sharp 12.5 cm
 42.1239.12 curved sharp 12.5 cm



LISTER (BANDAGE)
 42.1243.14
 14 cm

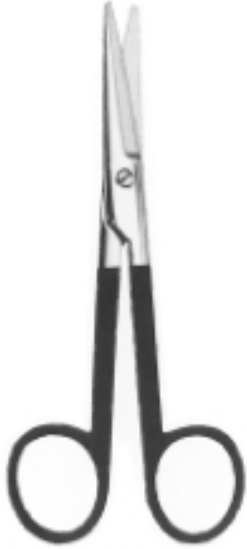

MAYO-STILE SUPER CUT
42.1246.15 straight 15 cm
42.1251.15 curved 15 cm



STILE-MAYO SUPER CUT
42.1254.15 straight 15 cm
42.1258.17 straight 17 cm
42.1261.15 curved 15 cm
42.1265.17 curved 17 cm



MAYO-HARRINGTON SUPER CUT
42.1270.20 straight 20 cm
42.1274.23 straight 23 cm



STILLE-RANGELL SUPER CUT
42.1277.12 curved 12.5 cm
42.1281.15 curved 15 cm
42.1285.18 curved 18 cm
42.1289.20 curved 20 cm
42.1291.23 curved 23 cm

Scissors-Micro **Super Cut**
 Scheren-Micro-**Schliff**
 Tijeras **Super Cortes** Con Micropulido



METZENBAUM SUPER CUT

- 42.1294.15 straight 15 cm
- 42.1298.18 straight 18 cm
- 42.1302.20 straight 20 cm
- 42.1306.23 straight 23 cm
- 42.1310.26 straight 26 cm



METZENBAUM SUPER CUT

- 42.1313.15 curved 15 cm
- 42.1317.18 curved 18 cm
- 42.1321.20 curved 20 cm
- 42.1325.23 curved 23 cm
- 42.1329.26 curved 26 cm

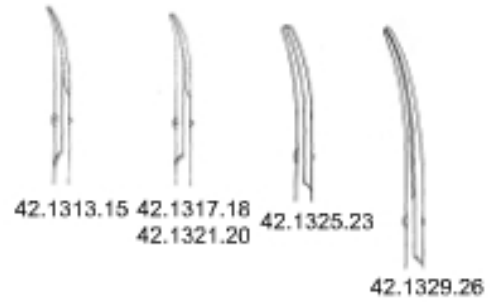

BABY METZENBAUM SUPER CUT

- 42.1334.12 straight 12.5 cm
- 42.1337.12 curved 12.5 cm

42.1334.12 42.1337.12



IRIS WITHOUT TC
42.1342.11 STRAIGHT
42.1345.11 CURVED
11.5 cm



IRIS WITH TC
42.1348.11 STRAIGHT
42.1351.11 CURVED
11.5 cm



LA GRANGE WITHOUT TC
42.1355.11
11.5 cm



LA GRANGE WITH TC
42.1359.11
11.5 cm

Episiotomy Scissors
Episiotomie Scheren
Tijeras Para Episiotomia

Umbilical Scissors
Nabelschnur-Scheren
Tijeras Umbilicales

Ligature Scissors
Ligaturscheren
Tijeras Para Ligaduras



BRAUN-STADLER
42-1400.14 14.5 cm
42-1402.22 22.0 cm

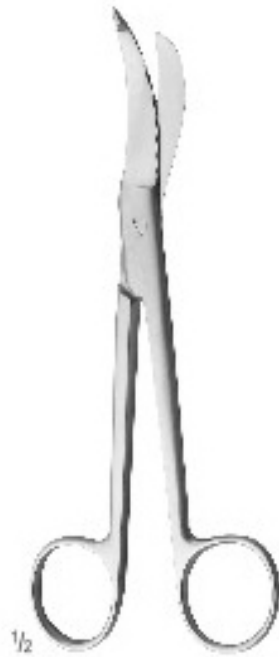

WALDMANN
42.1404.18
18 cm



Mod. USA
42.1408.10
10.5 cm



BUSCH
42.1412.16
16 cm



SCHOEMAKER-LOTH
42.1416.13
13 cm



KNIGHT
42.1420.17
17 cm



Artery Forceps



Artery Forceps, Dissecting and Ligature Forceps
Arterienklemmen, Präparier- und Ligaturklemmen
Pinzas hemostaticas, Pinzas para preparaciones y ligaduras

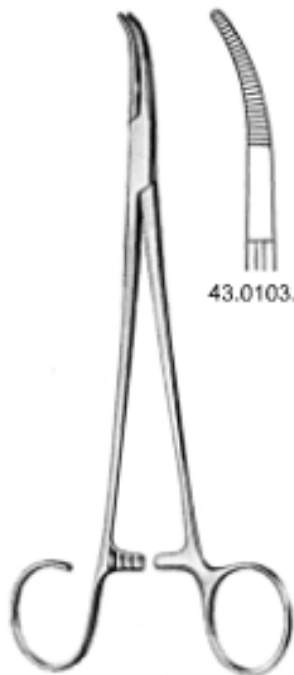

43.0103.19 43.0107.19

SCHNIDT-SAWTELL
43.0103.19 - 43.0107.19
19 cm



DIXON-LOVELACE
43.0110.15
15.5 cm



DIXON-LOVELACE
43.0114.15
15.5 cm



43.0117.19 43.0121.19

SCHNIDT-SAWTELL
43.0117.19 - 43.0121.19
19 cm



OVERHOLT-MIXTER
43.0125.21
21 cm

43

Artery Forceps, Dissecting and Ligature Forceps
Arterienklemmen, Präparier- und Ligaturklemmen
Pinzas hemostaticas, Pinzas para preparaciones y ligaduras

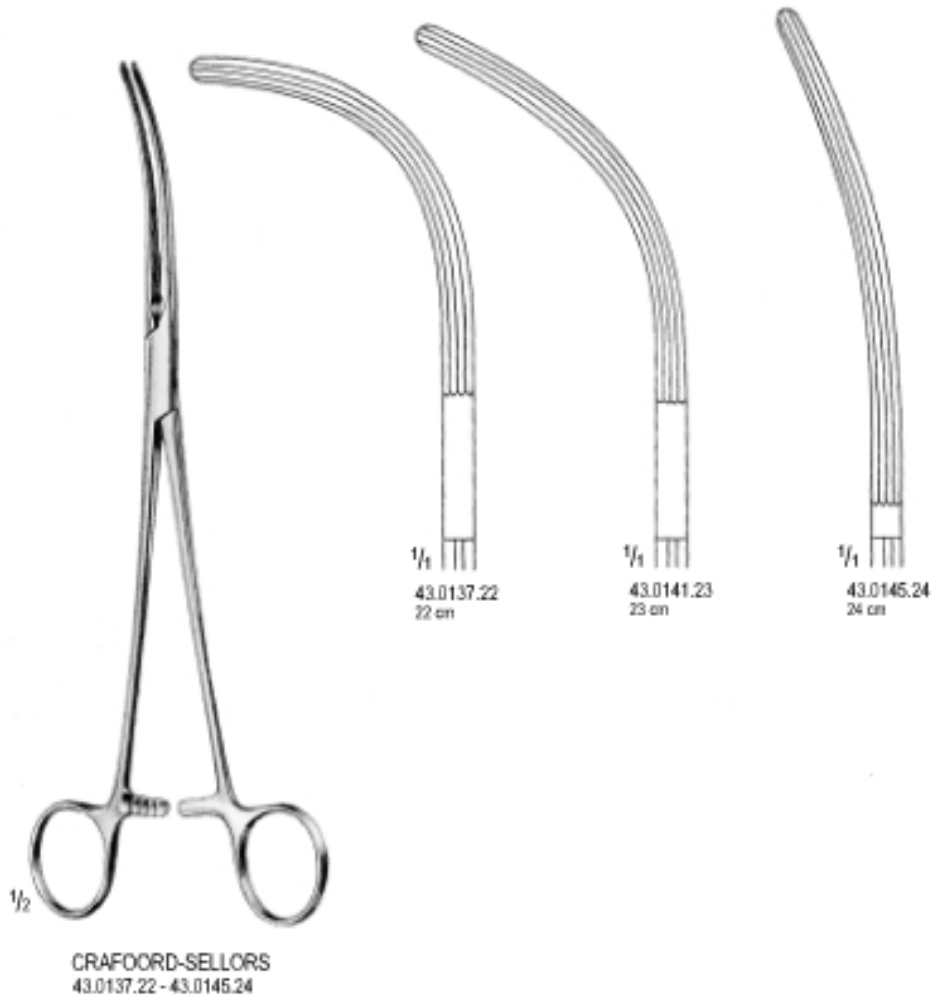
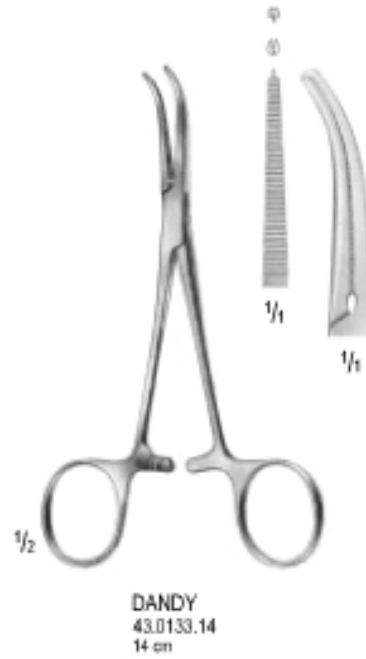

Artery Forceps, Dissecting and Ligature Forceps
 Arterienklemmen, Präparier- und Ligaturklemmen
 Pinzas hemostaticas, Pinzas para preparaciones y ligaduras

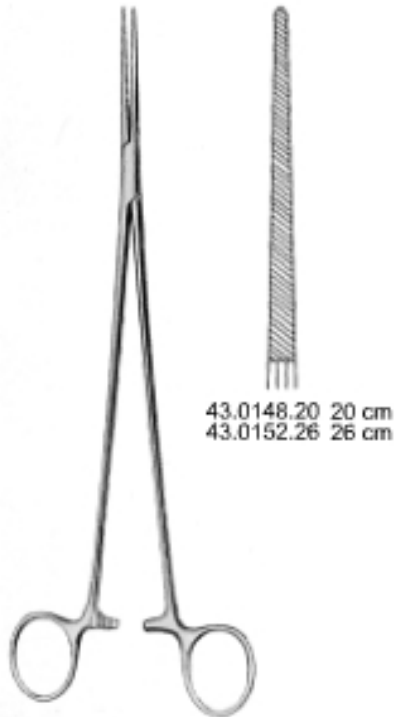

43.0148.20 20 cm
 43.0152.26 26 cm

BENGOLEA
 43.0148.20 - 43.0153.26



43.0149.20 20 cm
 43.0153.26 26 cm

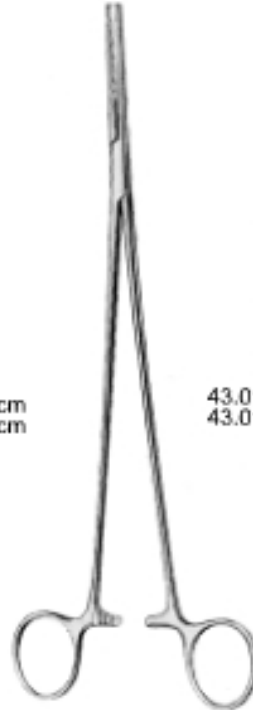

43.0156.20 20 cm
 43.0160.26 26 cm

BENGOLEA
 43.0156.20 - 43.0161.26



43.0157.20 20 cm
 43.0161.26 26 cm

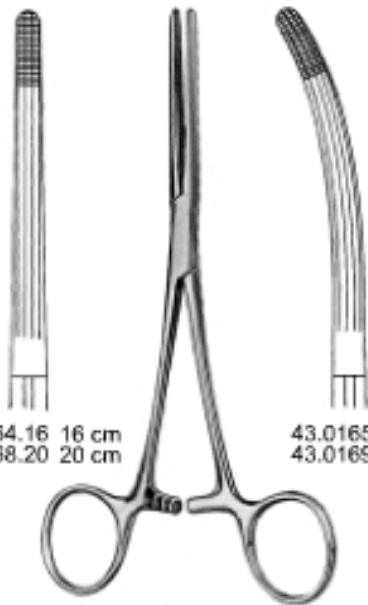

43.0164.16 16 cm
 43.0168.20 20 cm

43.0165.16 16 cm
 43.0169.20 20 cm

ROCHESTER-CARMALT
 43.0164.16 - 43.0169.20



43.0172.15 15 cm
 43.0176.18 18.5 cm

43.0173.15 15 cm
 43.0177.18 18.5 cm

BAINBRIDGE
 43.0172.15 - 43.0177.18

43

Artery Forceps, Dissecting and Ligature Forceps
 Arterienklemmen, Präparier - und Ligaturklemmen
 Pinzas hemostaticas, Pinzas para preparaciones y ligaduras



43.0180.22



43.0181.22



ROBERTS
 43.0180.22 - 43.0181.22
 22 cm



43.0184.24



43.0186.24

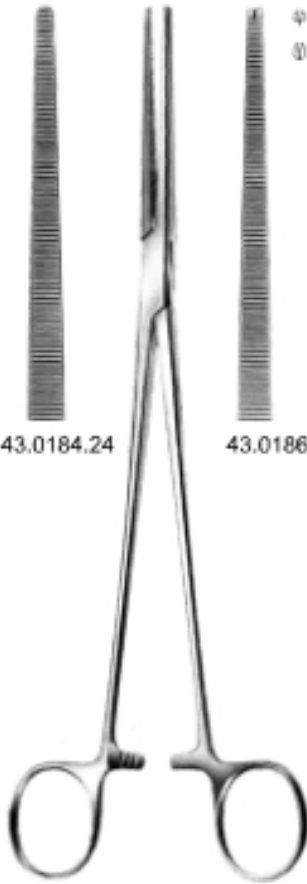

SAROT
 43.0184.24-43.0186.24
 24 cm



CRAFOORD
 43.0189.24
 24 cm

Artery Forceps, Dissecting and Ligature Forceps
 Arterienklemmen, Präparier- und Ligaturklemmen
 Pinzas hemostaticas, Pinzas para preparaciones y ligaduras

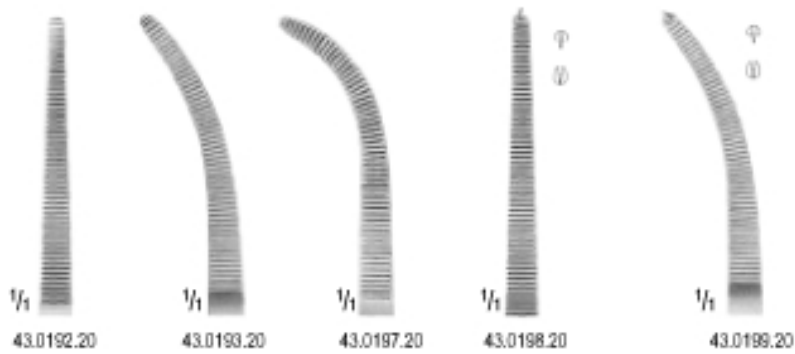

HEISS
 43.0192.20-43.0199.20
 20 cm

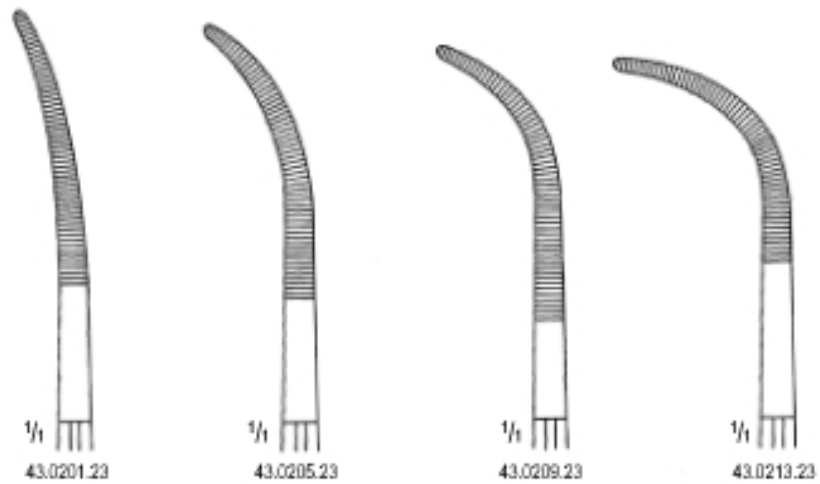

RUMEL
 43.0201.23-43.0213.23
 23 cm

43

Artery Forceps, Dissecting and Ligature Forceps
Arterienklemmen, Präparier - und Ligaturklemmen
Pinzas hemostaticas, Pinzas para preparaciones y ligaduras



JOHNS HOPKINS
43.0217.20
20 cm



ZENKER
43.0221.29 - 43.0225.29
29.5 cm

Artery Forceps, Dissecting and Ligature Forceps
 Arterienklemmen, Präparier - und Ligaturklemmen
 Pinzas hemostaticas, Pinzas para preparaciones y ligaduras



OVERHOLT-GEISSENDOERFER
 43.0229.21 - 43.0281.27

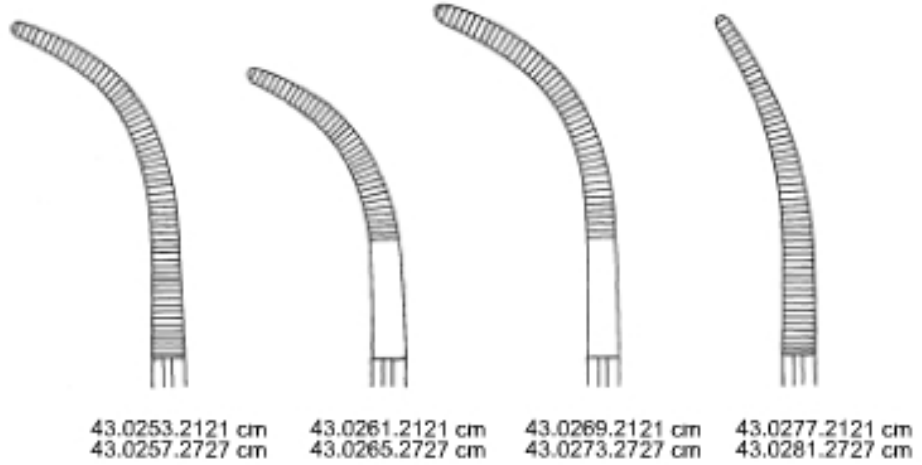
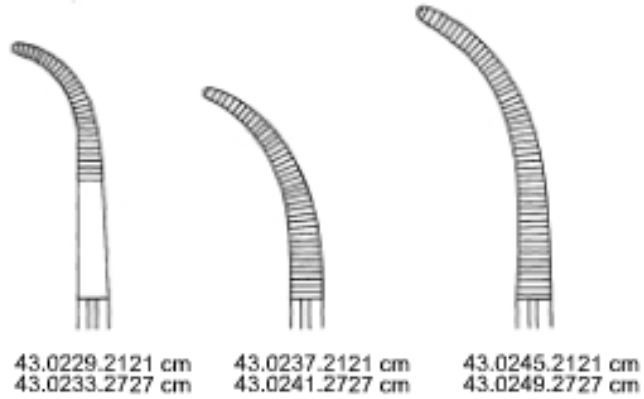

43

Artery Forceps, Dissecting and Ligature Forceps
Arterienklemmen, Präparier- und Ligaturklemmen
Pinzas hemostaticas, Pinzas para preparaciones y ligaduras



OVERHOLT
43.0285.18
18.5 cm



OVERHOLT
43.0289.20
20.5 cm



OVERHOLT
43.0293.21
21 cm



OVERHOLT
43.0297.21
21 cm



S-shaped
S-forming gebogen
curvas en S

Artery Forceps, Dissecting and Ligature Forceps
 Arterienklemmen, Präparier- und Ligaturklemmen
 Pinzas hemostaticas, Pinzas para preparaciones y ligaduras



MEEKER
 43.0301.18 - 43.0305.28



43.0301.18
 18 cm



43.0305.28
 28 cm



ADSON
 43.0308.18 - 43.0309.18
 18.5 cm



43.0308.18



43.0309.18



ADSON
 43.0312.18 - 43.0313.18
 18.5 cm



43.0312.18



43.0313.18



BABY-ADSON
 43.0317.14
 14 cm



BABY-ADSON
 43.0321.18
 18 cm



43

Artery Forceps, Seizing Forceps
Aterienklemmen, Faßzangen
Pinzas hemostaticas, Pinzas para coger



CHAPUT
43.0324.13
13 cm



TUFFIER
43.0328.13
13 cm

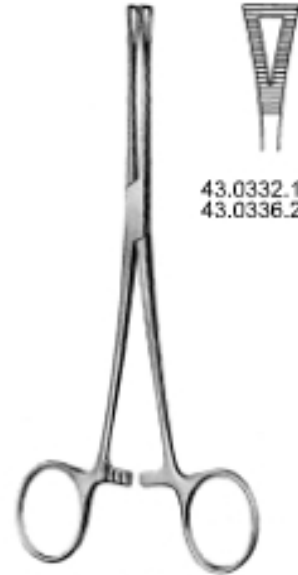

43.0332.15 15.5 cm
43.0336.20 20 cm

PENNINGTON
43.0332.15 - 43.0336.20



MARTEL
43.0340.14
14 cm



WILLET-MARTEL
43.0344.19
19 cm

Artery Forceps
Arterienklemmen
Pinzas hemostáticas



SPENCER-WELLS
43.0348.13-43.0363.20

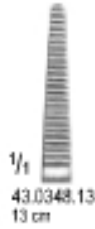

CARREL
43.0366.08
8.5 cm



TERRIER
43.0370.08
8.5 cm

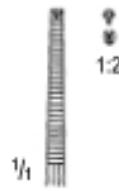

BABY-MOSQUITO
43.0374.10 - 43.0383.10
10 cm

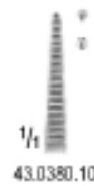
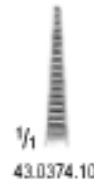

43

Dissecting and Ligature Forceps
Präparier- und Ligaturklemmen
Pinzas para preparaciones y ligaduras



MIXTER
43.0385.22 - 43.0393.28

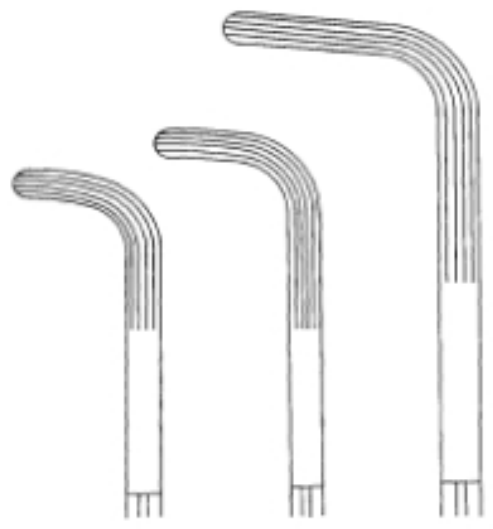

43.0385.22 22 cm 43.0389.25 25 cm 43.0393.28 28 cm



MIXTER
43.0395.15 - 43.0399.19



43.0395.15 15 cm 43.0399.19 19 cm

Dissecting and Ligature Forceps
Präparier - und Ligaturklemmen
Pinzas para preparaciones y ligaduras

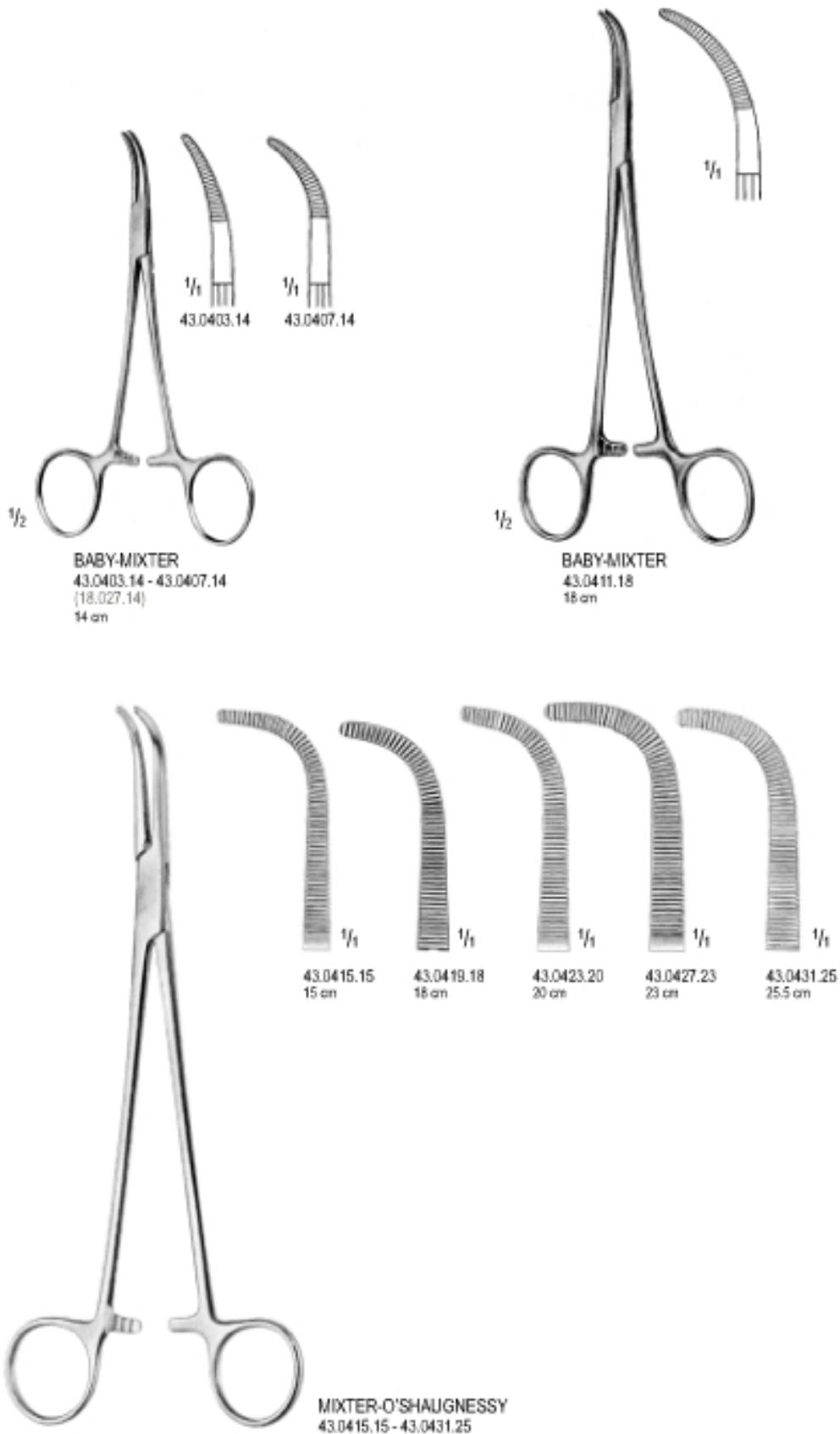

43

Dissecting and Ligature Forceps
Präparier - und Ligaturklemmen
Pinzas para preparaciones y ligaduras

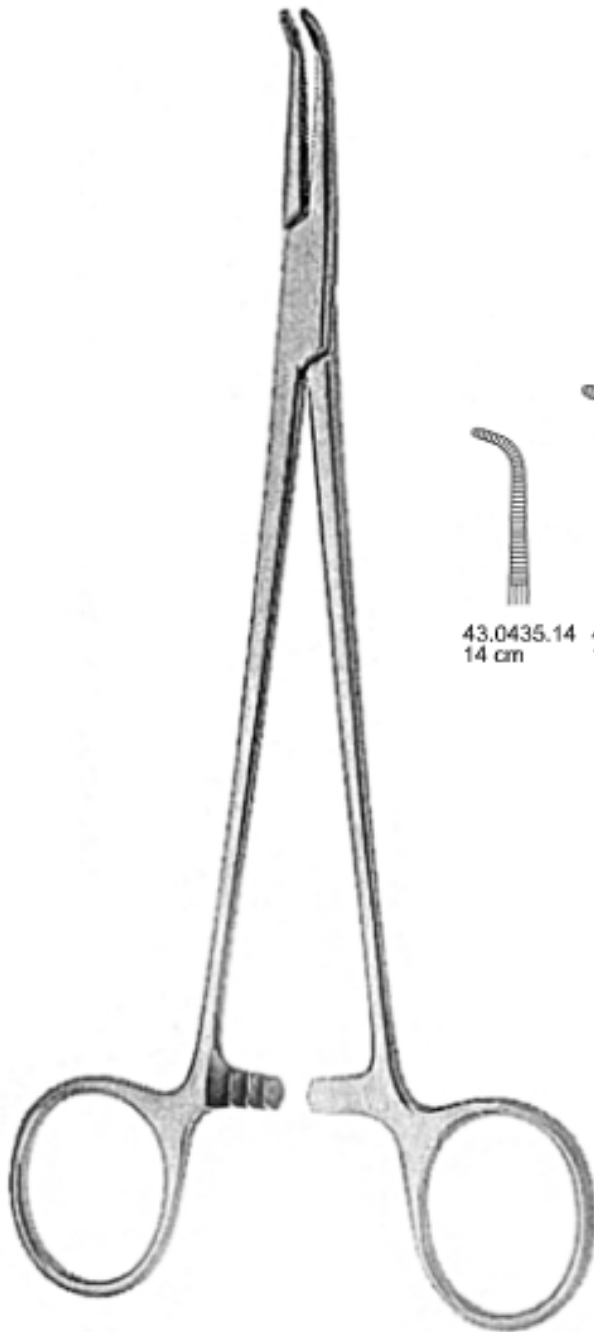

GIMINI
43.0435.14 - 43.0449.28

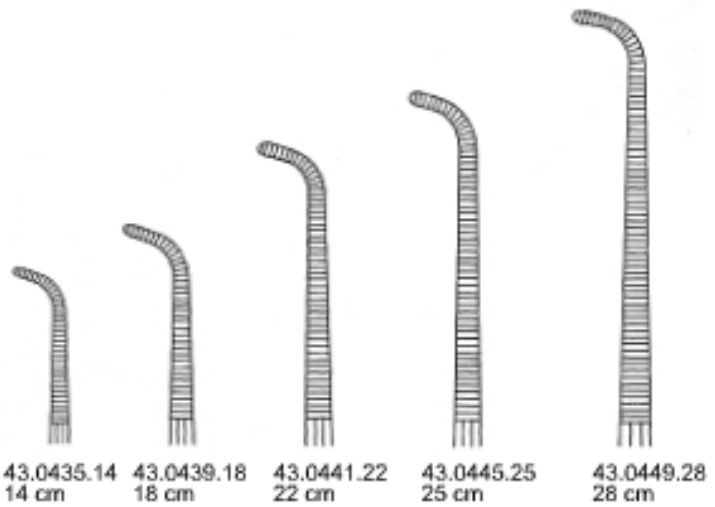

Dissecting and Ligature Forceps
Präparier - und Ligaturklemmen
Pinzas para preparaciones y ligaduras



43.0452.21 21 cm 43.0459.21 21 cm
43.0456.26 26 cm 43.0463.26 26 cm

TOENNIS
43.0452.21 - 43.0463.26



43.0466.21 21 cm 43.0473.21 21 cm
43.0470.26 26 cm 43.0475.26 26 cm

TOENNIS
43.0466.21 - 43.0475.26

43

Fine Artery Forceps
Feine Arterienklemmen
Pinzas hémostatícas finas



KROENLEIN
43.0478.13
13 cm

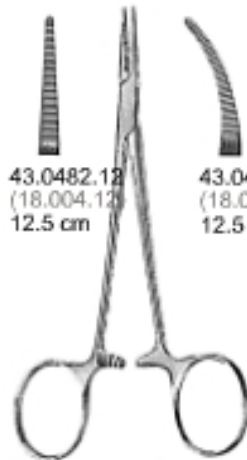

43.0482.12
(18.004.12)
12.5 cm

43.0485.12
(18.005.12)
12.5 cm

MICRO-HALSTED
43.0482.12 - 43.0485.12

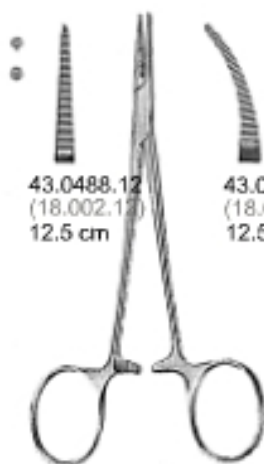

43.0488.12
(18.002.12)
12.5 cm



43.0491.12
(18.003.12)
12.5 cm

MICRO-MOSQUITO
43.0488.12 - 43.0491.12

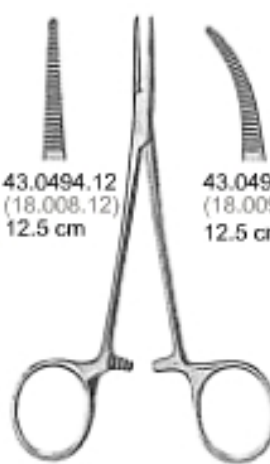

43.0494.12
(18.008.12)
12.5 cm



43.0497.12
(18.009.12)
12.5 cm

HALSTED-MOSQUITO
43.0494.12 - 43.0497.12

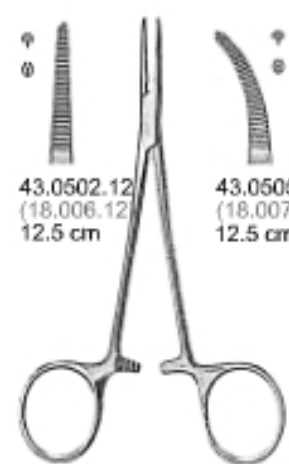

43.0502.12
(18.006.12)
12.5 cm



43.0505.12
(18.007.12)
12.5 cm

HALSTED-MOSQUITO
43.0502.10 - 43.0505.12

Artery Forceps
Arterienklemmen
Pinzas hémstaticas

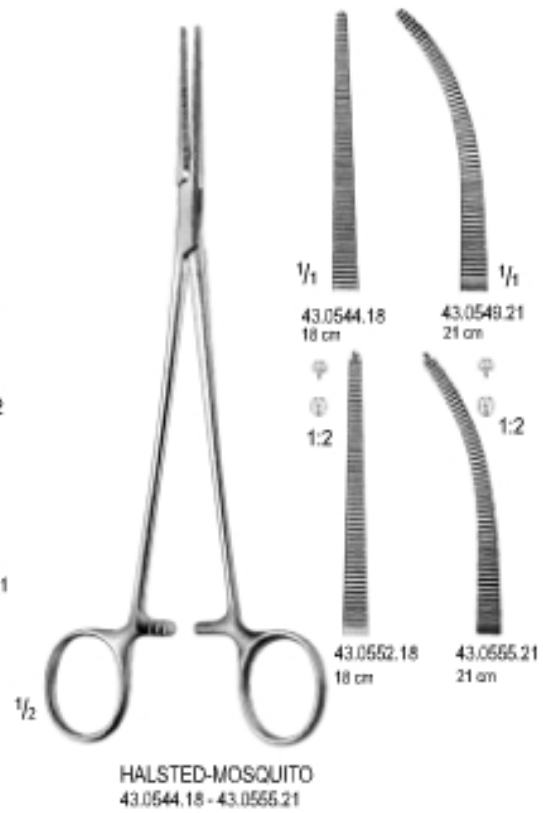
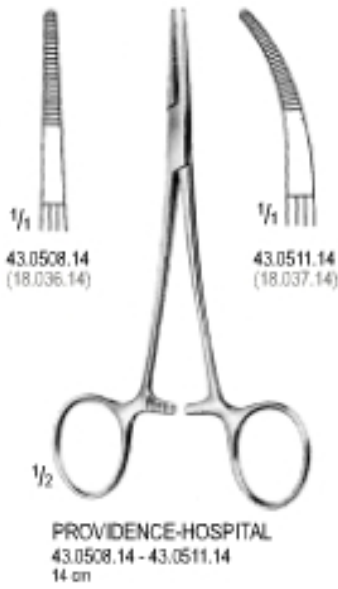

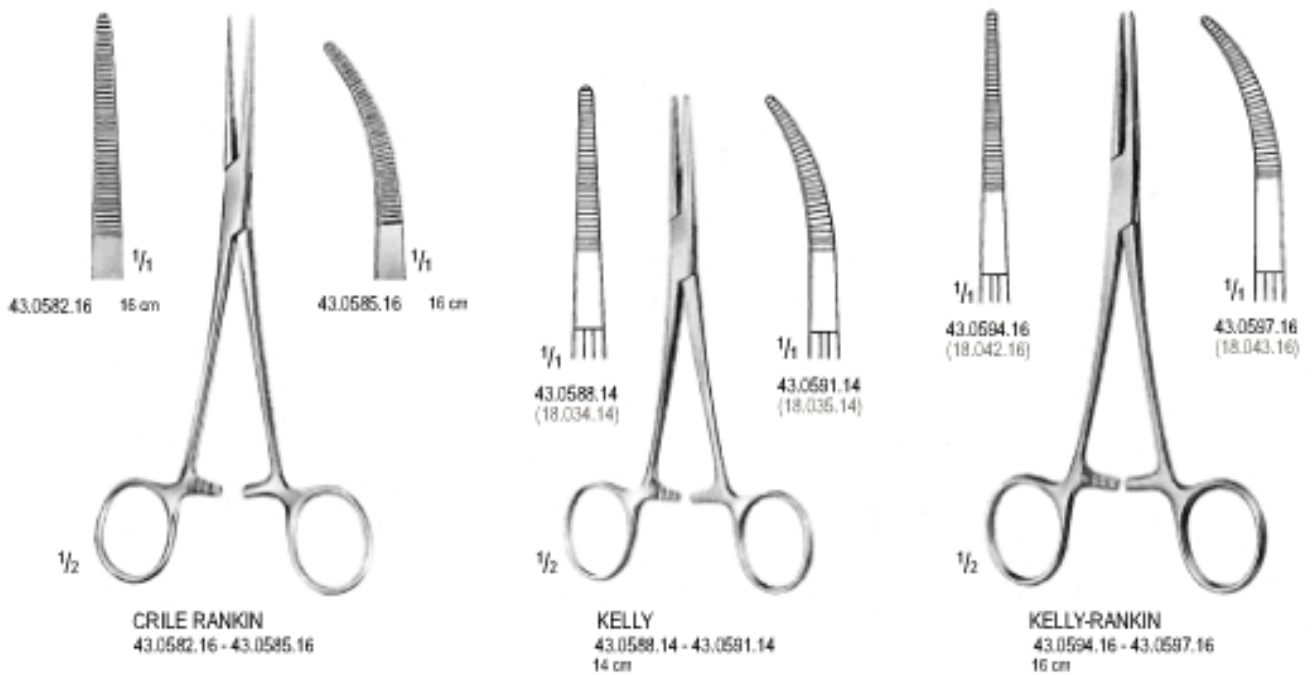
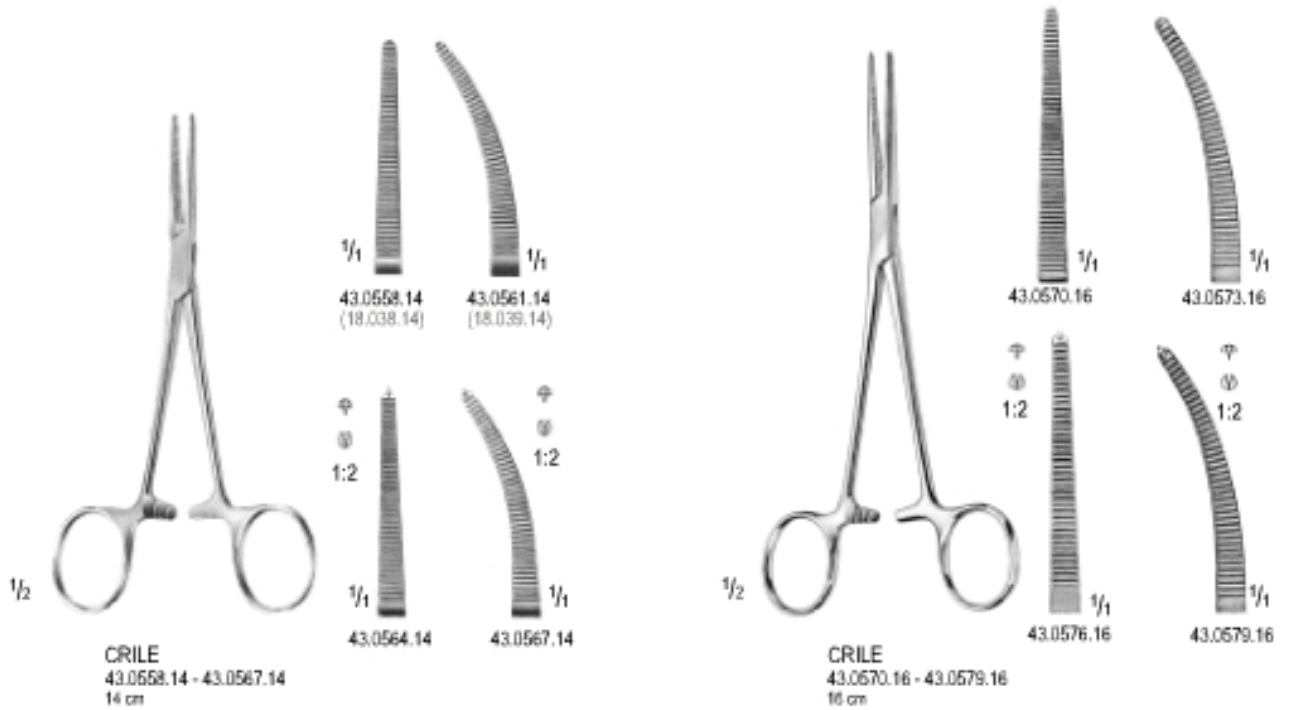



1/2

PEAN
43.0603.14 - 43.0631.30

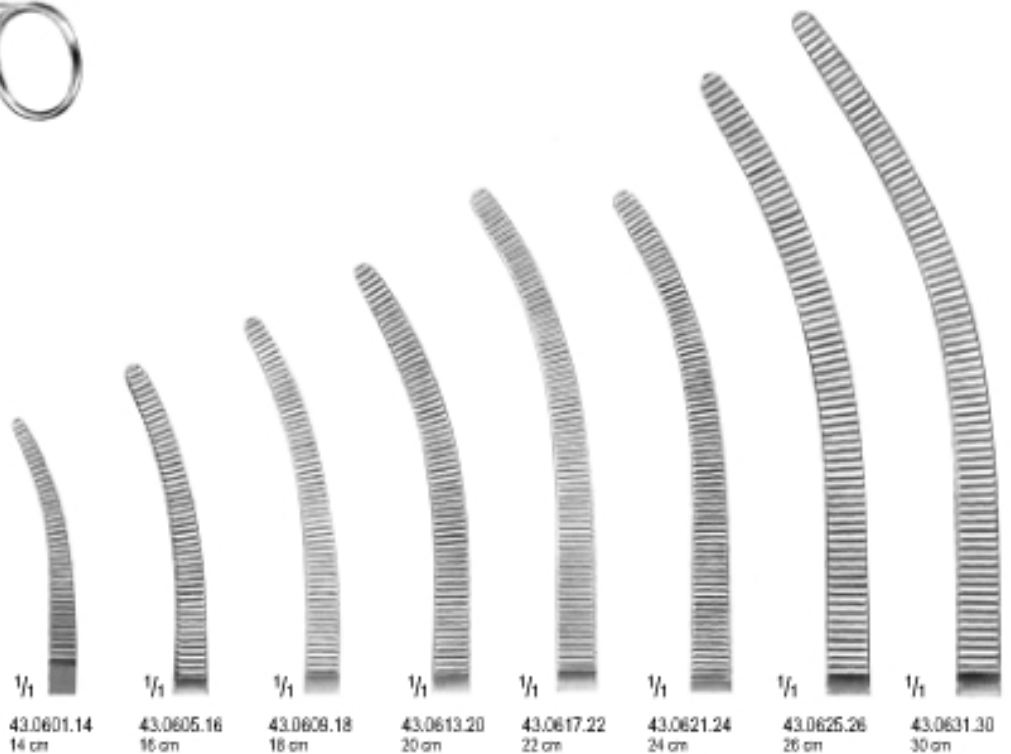
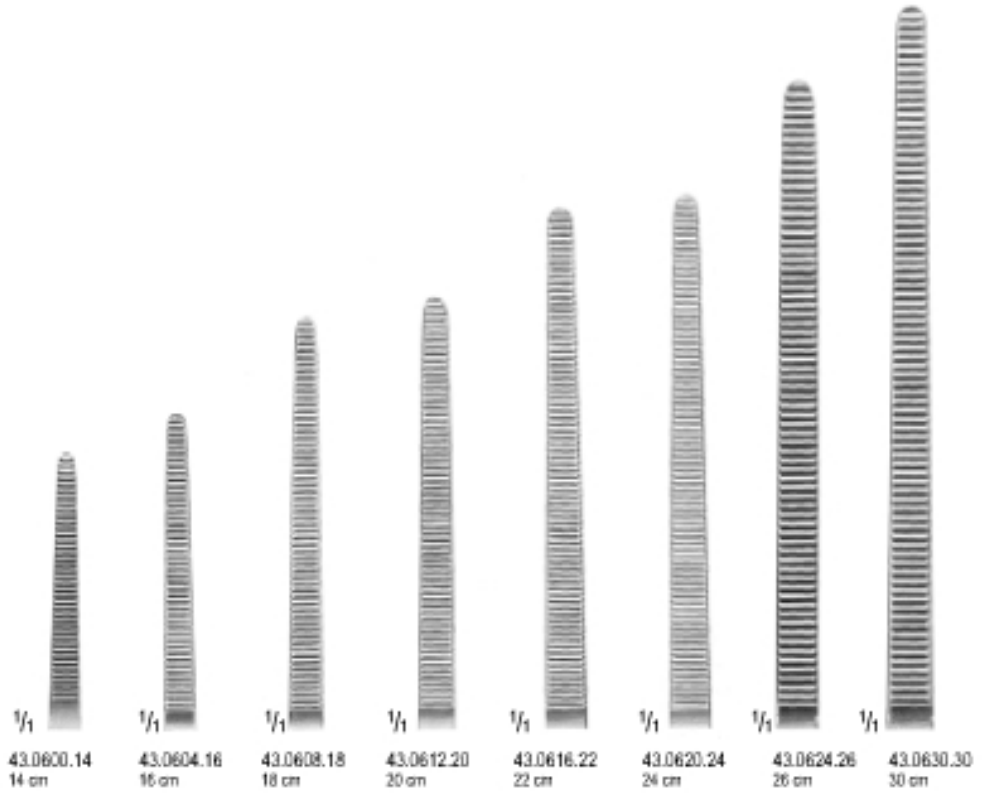

43

Artery Forceps
Arterienklemmen
Pinzas hémastáticas



KOCHER-OCHSNER
43.0634.14 - 43.0663.30

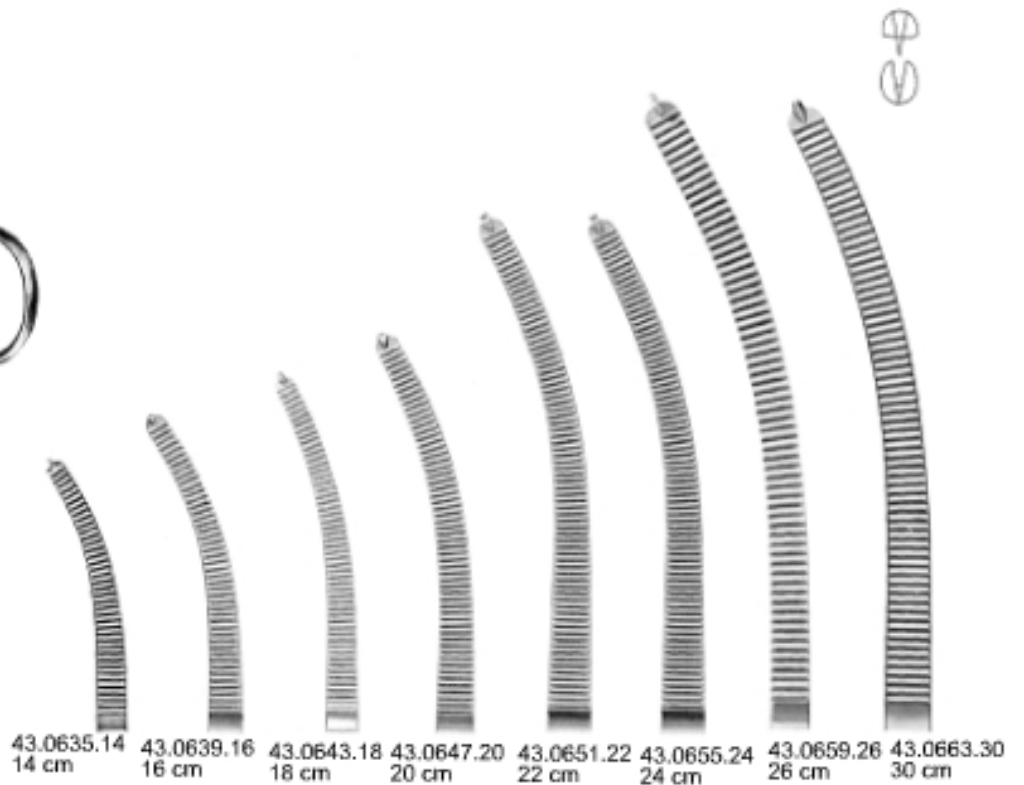
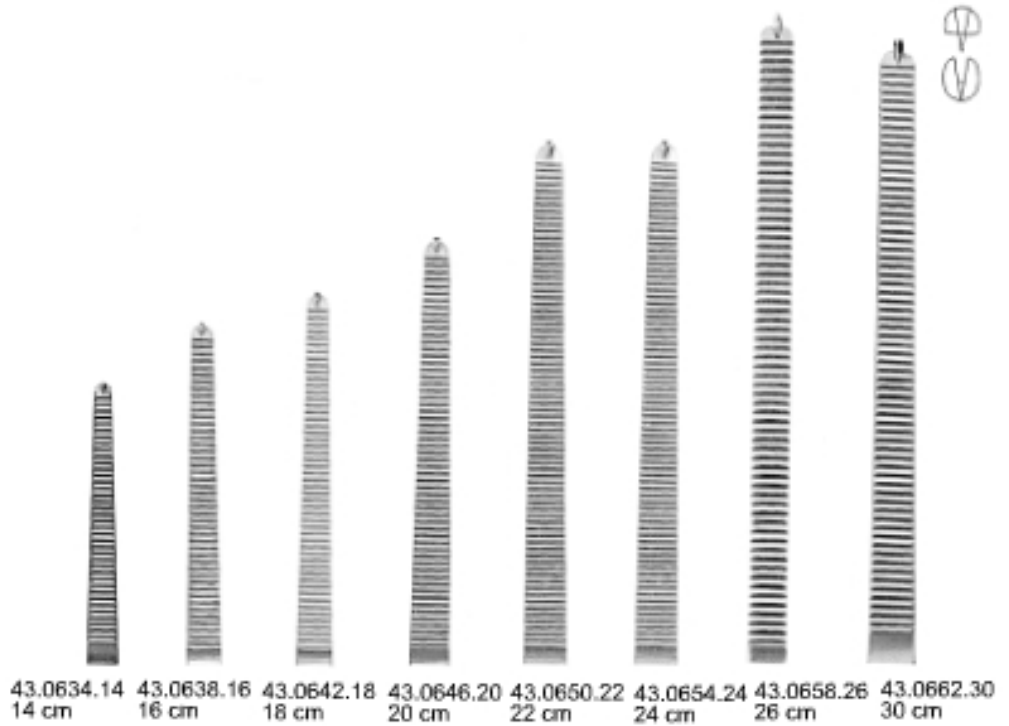

Delicate Artery Forceps
 Grazile Arterienklemmen
 Pinzas Hemostaticas delgadas

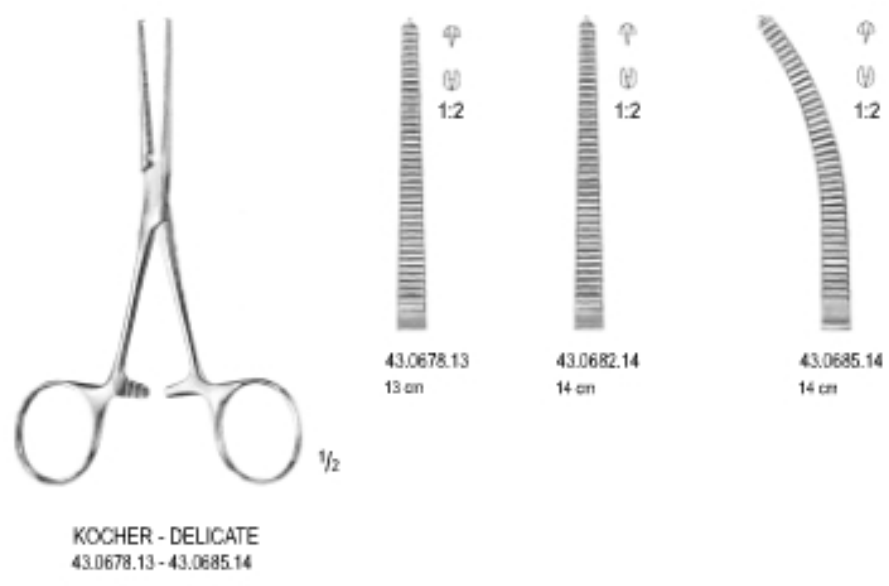
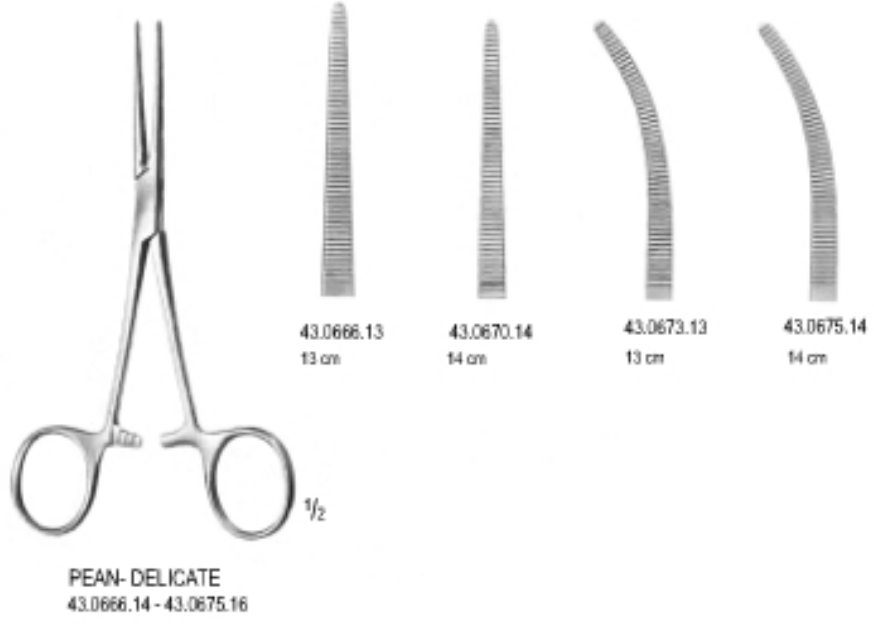

43

Delicate Artery Forceps
Grazile Arterienklemmen
Pinzas Hémostatias delgadas



PEAN
43.0690.14 - 43.0694.16



43.0690.14
14 cm



43.0694.16
16 cm



BABY-OVERHOLT
43.0697.13
13.5 cm

Hysterectomy Forceps
Hysterektomieklemmen
Pinzas-clamp para histerectomia

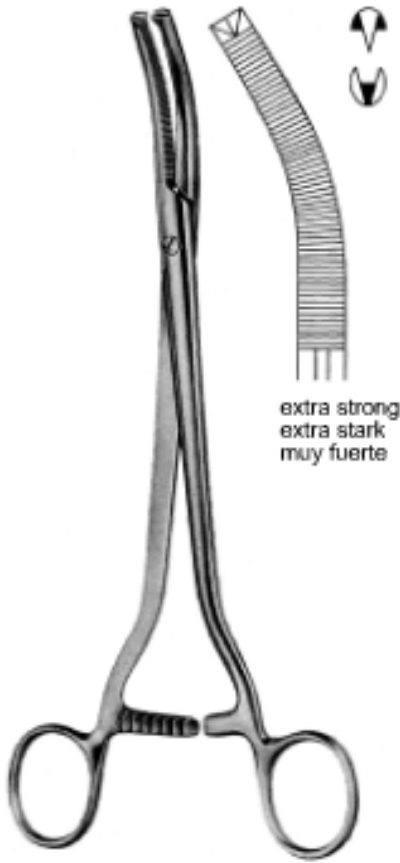

WERTHEIM
43.0701.24
24 cm



WERTHEIM
43.0703.25
25 cm

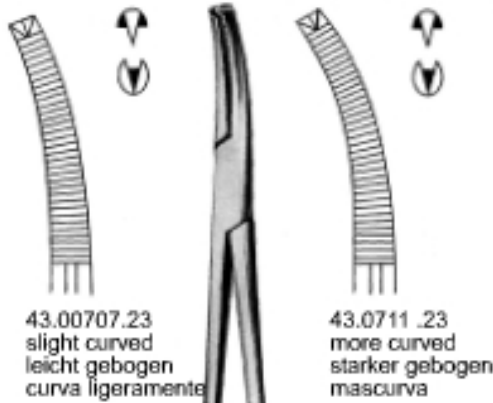

43.00707.23
slight curved
leicht gebogen
curva ligeramente

43.0711.23
more curved
starker gebogen
mascurva

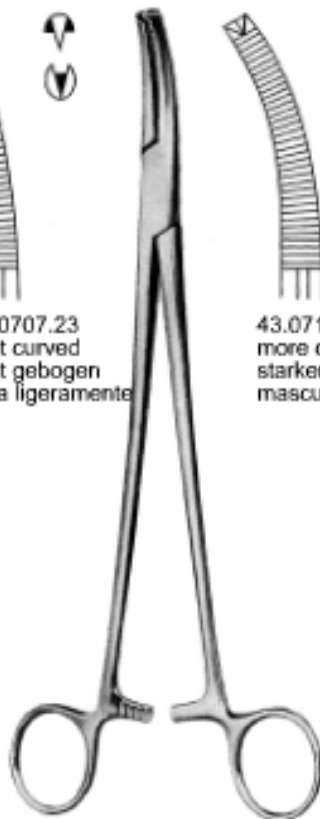

WERTHEIM
43.0707.23 - 43.0711.23
23 cm

43

Hysterectomy forceps
Hysterektomieklemmen
Pinzas-clamps para hysterectomia



WERTHEIM
43.0715.27
27 cm

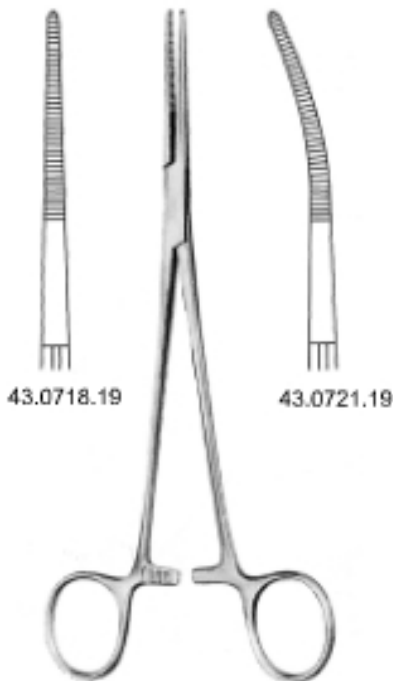

43.0718.19

43.0721.19

BIRKETT
43.0718.19-43.0721.19
19 cm



WIKSTROEM
43.0725.19
19 cm

Gall Duct and Kidney Pedicle Clamp Forceps
Gallenkanal-und Nierenstielklemmen
Pinzas-clamps para conducto biliar y pedúnculos renales

43



43.0729.19 43.0733.19

NEGUS
43.0729.19 - 43.0733.19
19 cm



DESJARDINS
43.0737.21
21 cm

43

Gall Duct and Kidney Pedicle Clamp Forceps
Gallenkanal-und Nierenstieltklemmen
Pinzas-clamps para conducto biliar y pedúnculos renales

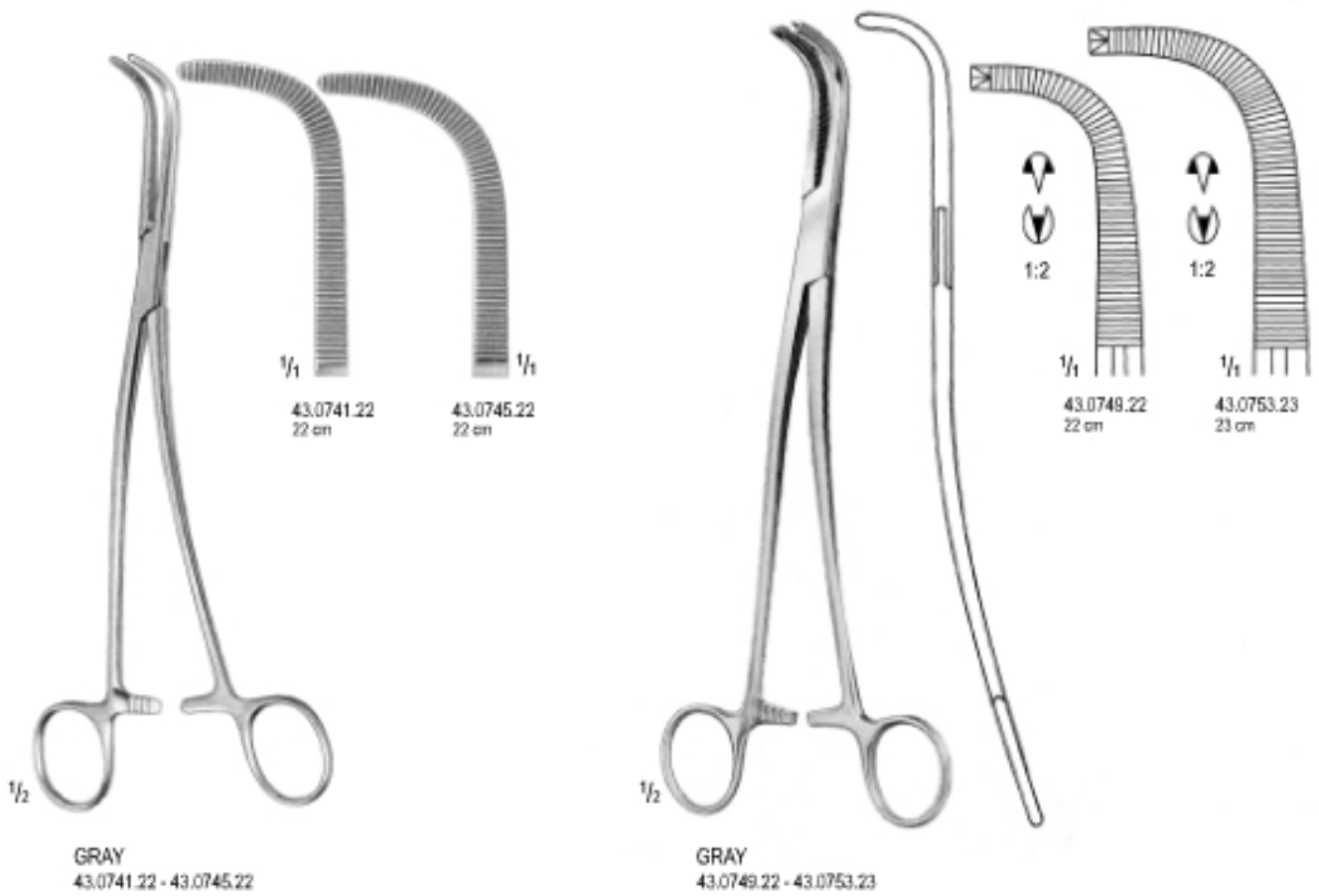

Gall Duct and Kidney Pedicle Clamp Forceps
Gallenkanal- und Nierenstielklemmen
Pinzas-clamps para conducto biliar y pedúnculos renales

43

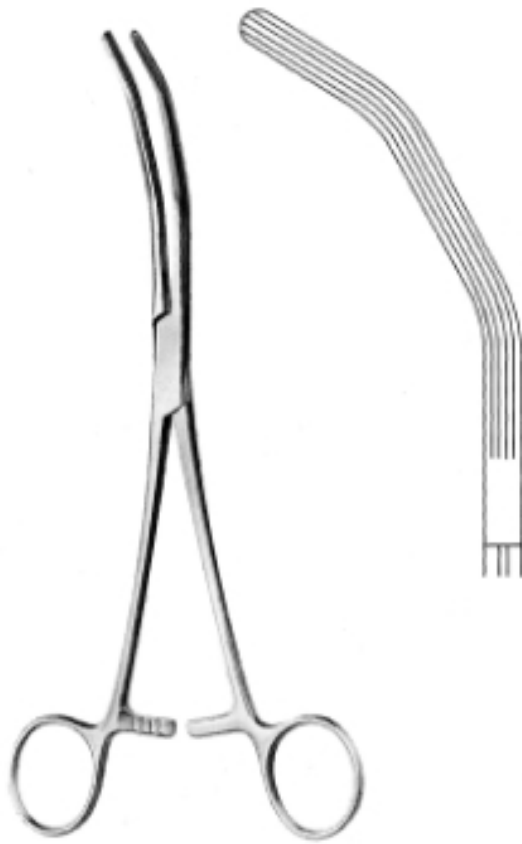

HERRICK
43.0757.23
23 cm



GUYON
43.0761.23
23 cm

43

Gall Duct and Kidney Pedicle Clamp Forceps
Gallenkanal-und Nierenstiellklemmen
Pinzas-clamps para conducto biliar y pedúnculos renales

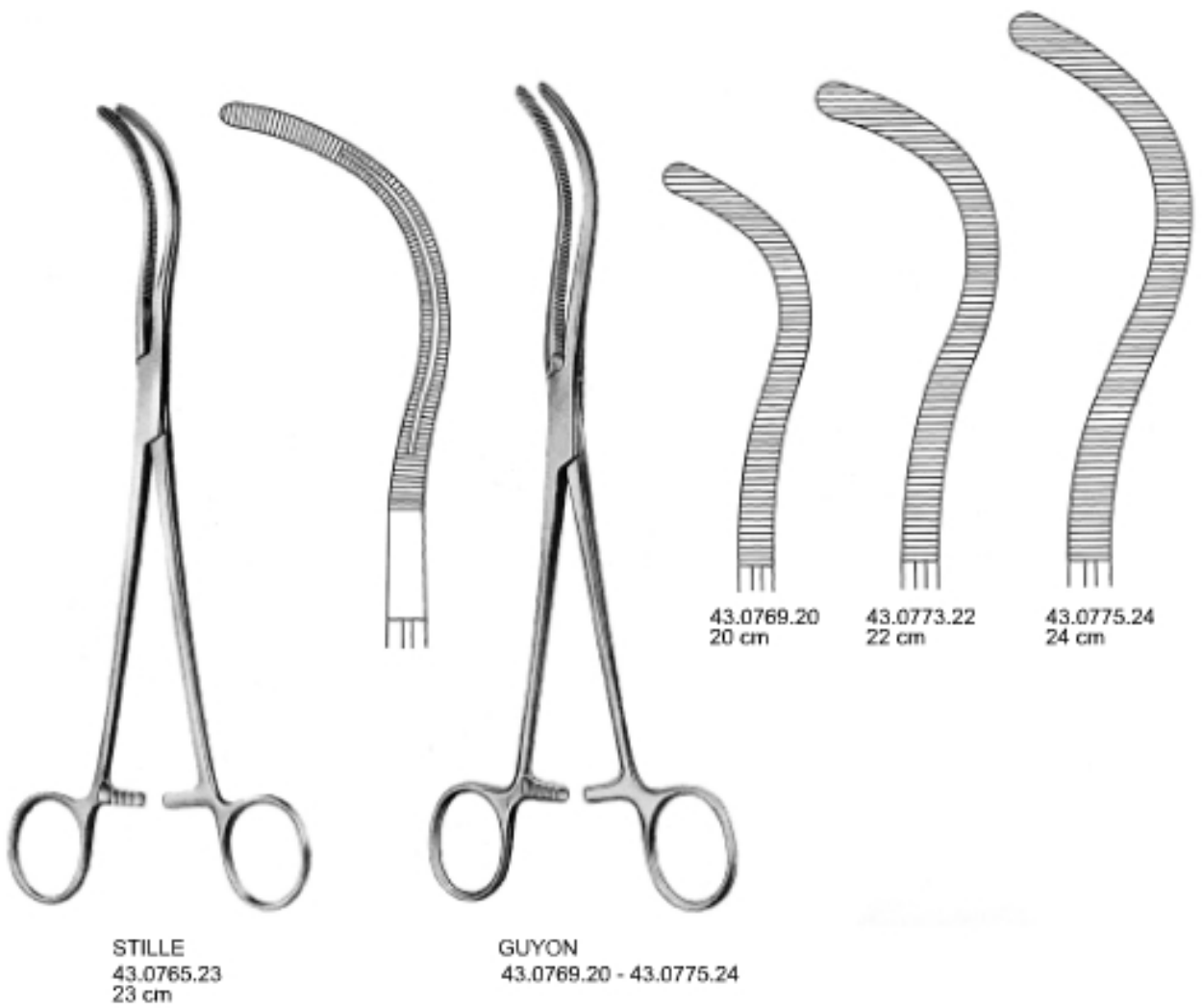

Gall Duct and Kidney Pedicle Clamp Forceps
Gallenkanal - und Nierenstiellklemmen
Pinzas-clamps para conducto biliar y pedunculos renales

43



FINOCCHIETTO
43.0777.24
24 cm

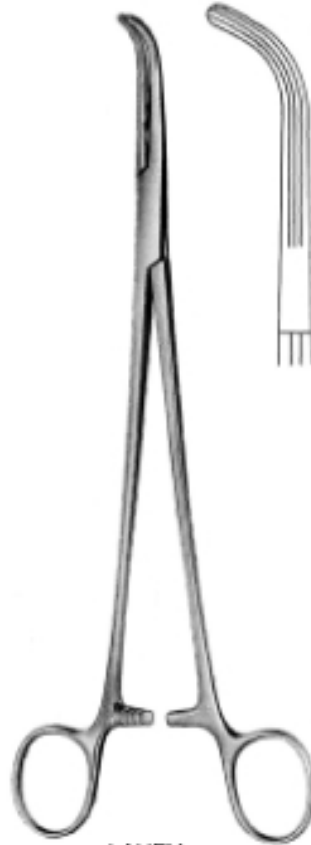

LAHEY
43.0781.23
23 cm



LOWER
43.0785.18
18 cm



KANTROWITZ
43.0789.20 - 43.0797.28



43.0789.20
20 cm



43.0793.24
24 cm

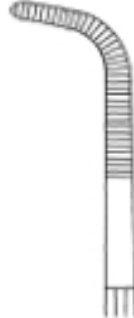

43.0797.28
28 cm

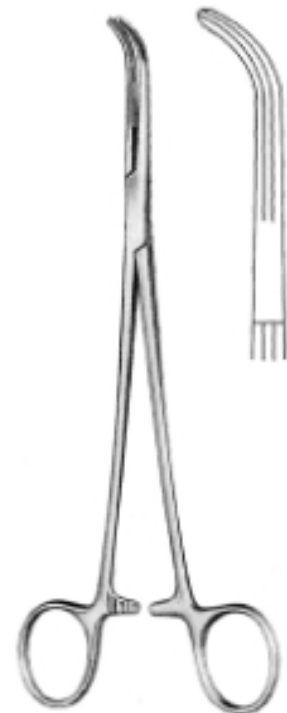

LAHEY
43.0801.19
19 cm

43

Gall Duct and Kidney Pedicle Clamp Forceps
Gallenkanal - und Nierenstielklemmen
Pinzas-clamps para conducto biliar y peduculos renales



LONG
43.0805.19
19 cm



GARLAND
43.0809.21
21 cm

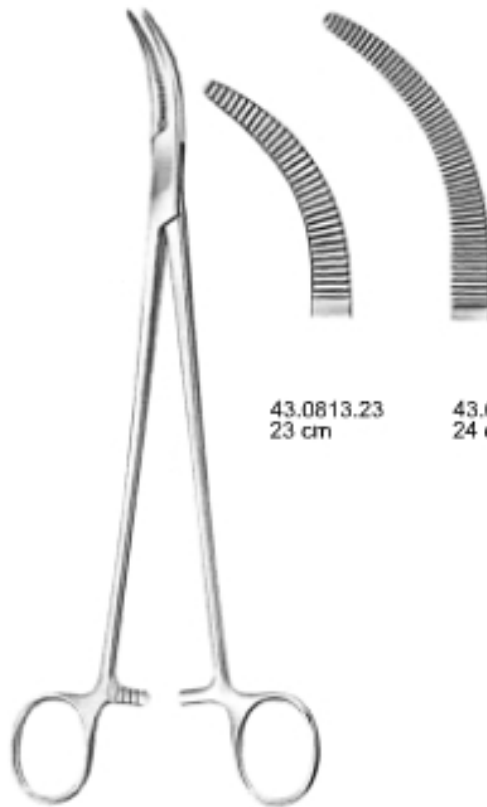

43.0813.23
23 cm

43.0817.24
24 cm

MOYNIHAN
43.0813.23 - 43.0817.24

Tubing Clamps
Schlauchklemmen
Pinzas para tubos

43



43

Towel Forceps
Tuchklemmen
Pinzas para compresas, Pinzas de campo



ROEDER
43.0857.13 13 cm 18.055.13
43.0861.15 15 cm 18.055.15



BACKHAUS
43.0865.08 8 cm 18.056.08
43.0869.11 11 cm 18.059.15
43.0873.13 13 cm 18.059.15



BALL AND SOCKET
43.0887.13
13 cm



PEERS
43.0877.14
14.5 cm



LORNA
43.0881.10 10 cm
43.0885.13 13 cm

Towel Forceps
Tuchklemmen
Pinzas para compresas, Pinzas de campo

43



LANE
43.0889.15 15 cm
43.0893.18 18 cm
43.0897.20 20 cm



DOYEN
43.0901.18
18 cm



BERNHARD
43.0905.16
16.5 cm



JONES
43.0909.056 cm 18.051.15
43.0913.099 cm



ENGL. MODELL
43.0917 .09
9 cm



SCHAEDEL
43.0921.09
9 cm

43

Peritoneal Clamp Forceps
Peritoneumklemmen
Pinzas-clamps para peritoneo



SCHINDLER
43.0925.20
20 cm



FAURE
43.0929.20 - 43.0933.20
20 cm



43.0929.20
slightly curved
leichtge gebogen
curva ligeramente



43.0933.20
more curved
starker gebogen
mas curva

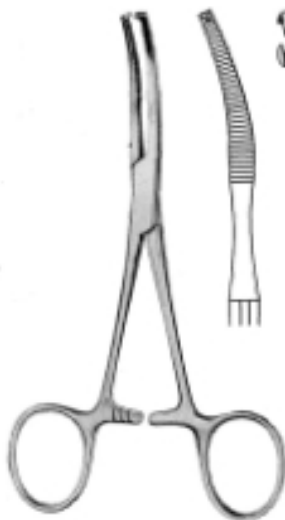

BABY-MIKULICZ
43.0937.14
14 cm



MIKULICZ
43.0941.18
18 cm

Peritoneal Clamp Forceps
Peritoneumklemmen
Pinzas-clamps para peritoneo



43.0945.20



43.0949.20



MIKULICZ
43.0953.20
20 cm



MIKULICZ
43.0957.23
23 cm



MIKULICZ
43.0961.20
20 cm

43

Angiotribes, Haemorrhoidal Forceps
Druckklemmen, Hamorrhoidenklemmen
Pinzas-clamps de presión progresiva, Pinzas hemorroidales



PRATT
43.0964.15
15 cm



FERGUSSON
43.0968.16 16 cm
43.0972.20 20 cm



FERGUSSON
43.0975.16 16 cm
43.0979.20 20 cm

Hysterectomy Forceps
Hysterektomieklemmen
Pinzas-clamps para hysterectomia

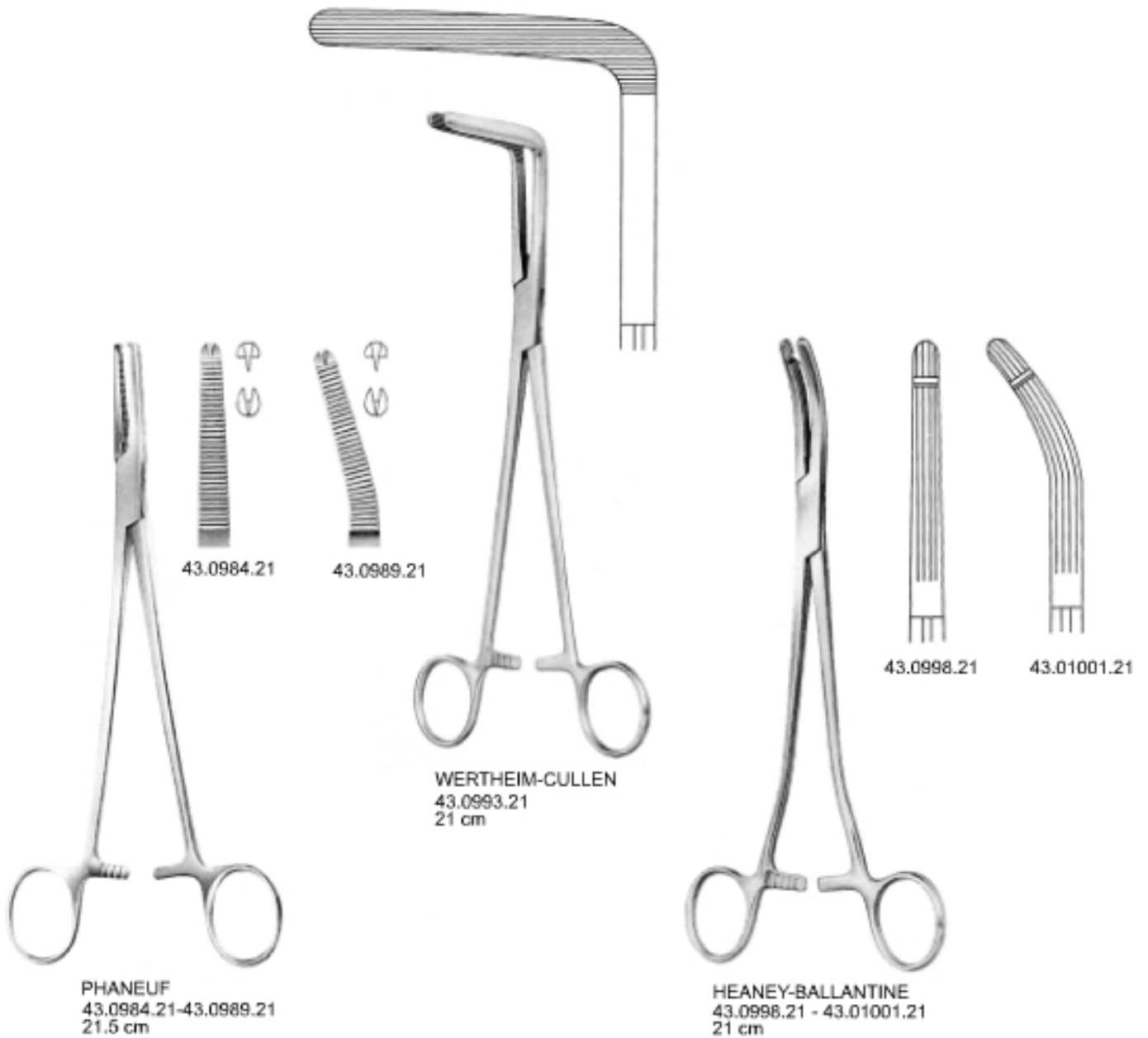

43

Hysterectomy Forceps
Hysterektomieklemmen
Pinzas-clamps para hysterectomia

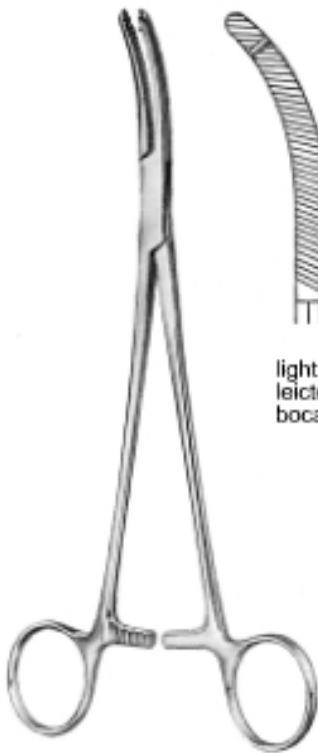

light jaws
leichtes Maul
boca ligera

HEANEY
43.1005.21
21 cm

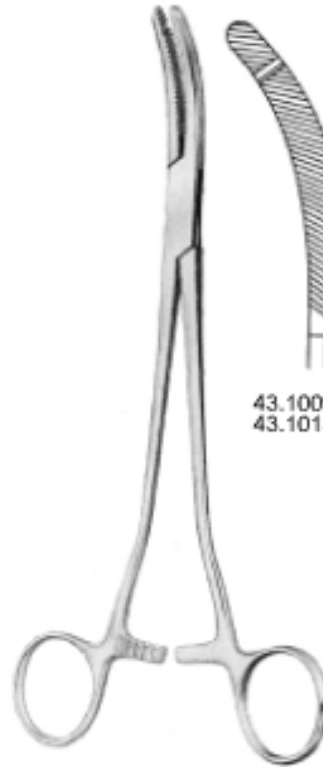

43.1009.21 21 cm 43.1017.21 21 cm
43.1013.23 23 cm 43.1021.23 23 cm

HEANEY
43.1009.21 - 43.1021.23



HEANEY-REZAK
43.1024.21
21 cm

Hysterectomy Forceps
Hysterektomieklemmen
Pinzas-clamps para hysterectomia

43



HEANEY-KANTER
43.1025.21
21 cm

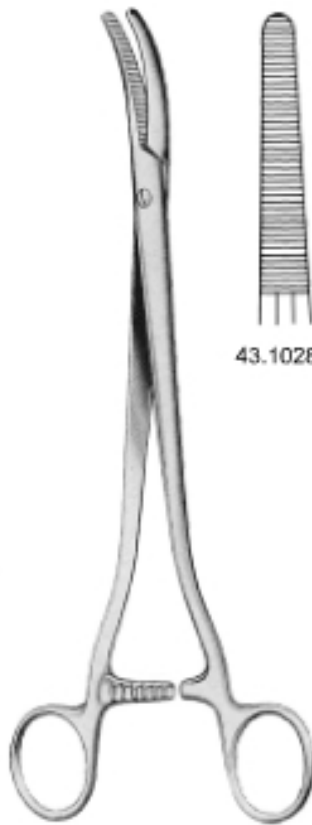

SEGOND-LANDU
43.1028.24 - 43.1033.24
24 cm



43.1028.24

43.1033.24



FAURE
43.1037.25
25 cm

43

Parametrium Forceps
Parametriumklemmen
Pinzas-clamps para parametrium

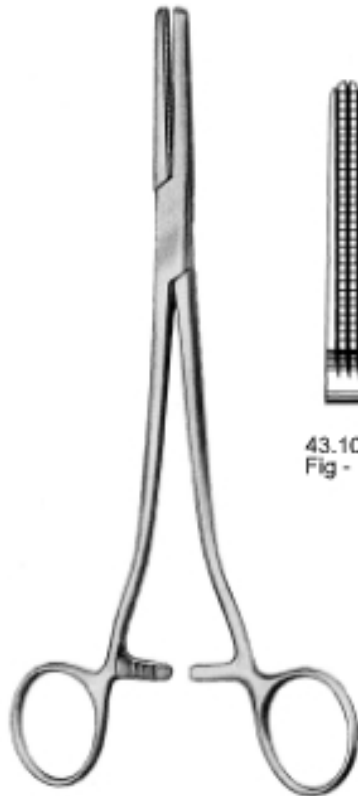

PARAMETRIUM
43.1040.21 - 43.1053.21
21 cm



43.1040.21
Fig - 1



43.1045.21
Fig - 2



43.1049.21
Fig - 3



43.1053.21
Fig - 4

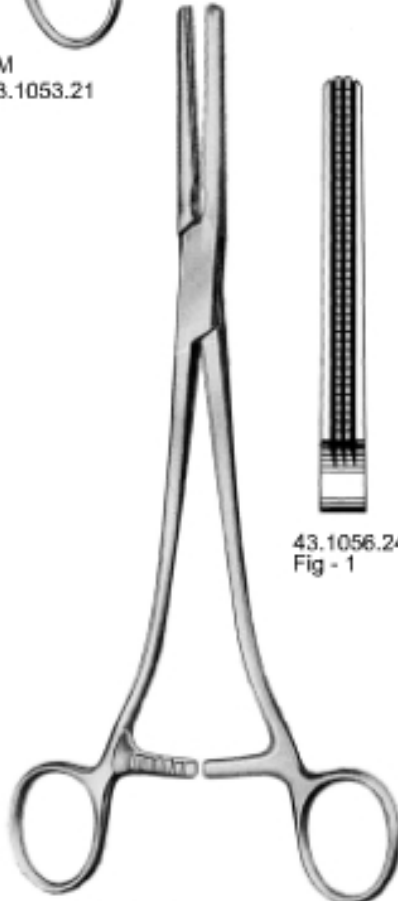

PARAMETRIUM
43.1056.24 - 43.1069.24
24 cm

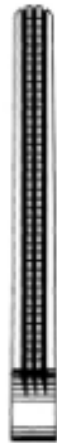

43.1056.24
Fig - 1



43.1061.24
Fig - 2



43.1065.24
Fig - 3



43.1069.24
Fig - 4

Kidney Stone Forceps
Nierensteinzangen
Pinzas para calculos renales

43

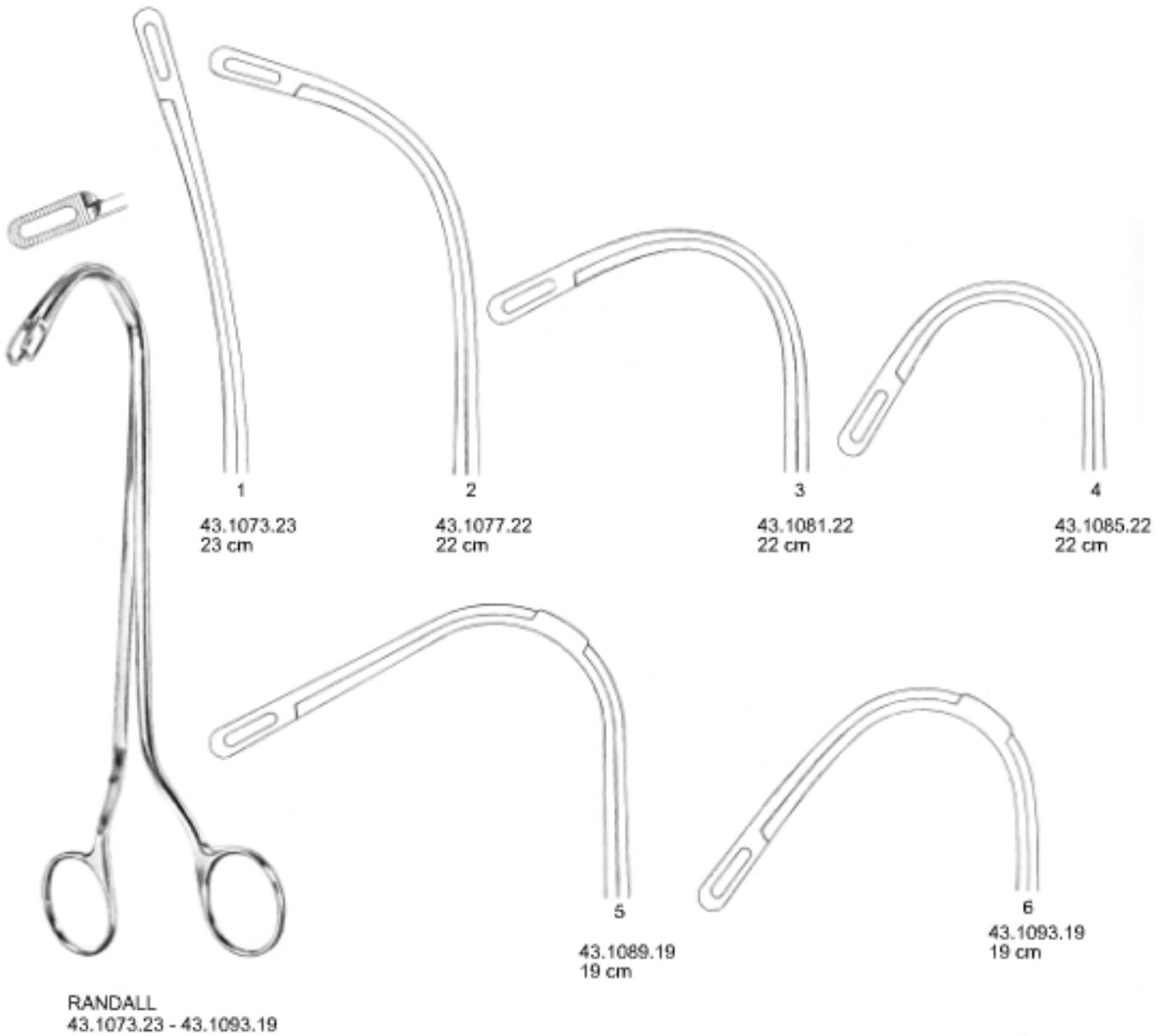



Forceps



Dressing Forceps, Tissue Forceps
 Anatomische Pinzetten, Chirurgische Pinzetten
 Pinzas de disección, Pinzas de disección con dientes



44.0102.12 12.5 cm
 44.0104.15 15 cm

SEMKEN
 44.0102.12 - 44.0104.15
 (02.165.00)

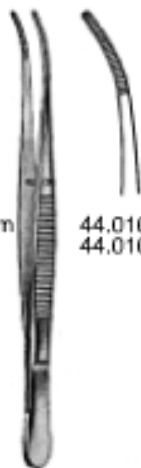

44.0103.12 12.5 cm
 44.0105.15 15 cm

SEMKEN
 44.0103.12 - 44.105.15



44.0106.12 12.5 cm
 44.0110.15 15 cm

SEMKEN
 44.0106.12 - 44.0110.15



44.0107.12 12.5 cm
 44.0111.15 15 cm

SEMKEN
 44.0107.12 - 44.0111.15



44.0114.12

44.0118.12

ADSON-BROWN
 44.0114.12 - 44.0118.12
 12 cm

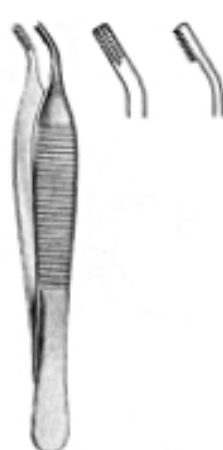

ADSON-BROWN
 44.0119.12
 12 cm

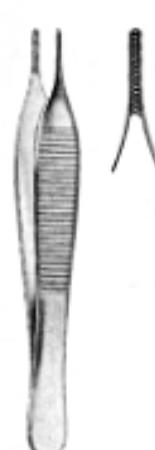

ADSON
 44.0122.12
 12 cm



ADSON
 44.0126.12
 12 cm



44.0130.1212 cm
44.0134.1515 cm

MICRO ADSON
44.0130.12 - 44.0134.15



44.0138.1212 cm
44.0142.1515 cm

MICRO ADSON
44.0138.12 - 44.0142.15



44.0146.1212 cm
44.0150.1515 cm

ADSON
44.0146.12 - 44.0150.15



44.0154.1212 cm
44.0158.1515 cm

ADSON
44.0154.12 - 44.0158.15

Dressing Forceps, Tissue Forceps
 Anatomische Pinzetten, Chirurgische Pinzetten
 Pinzas de diseccion, Pinzas de diseccion con dientes

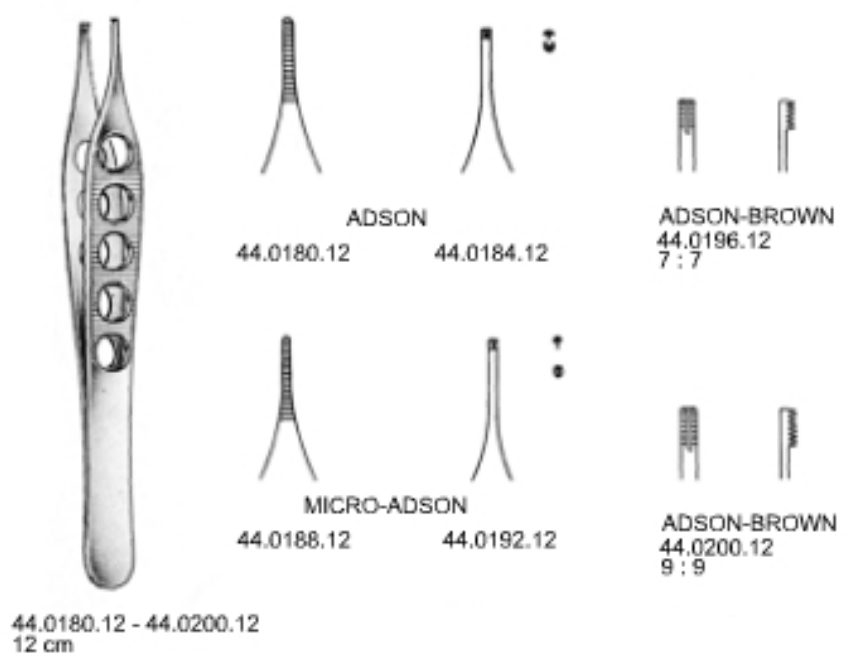
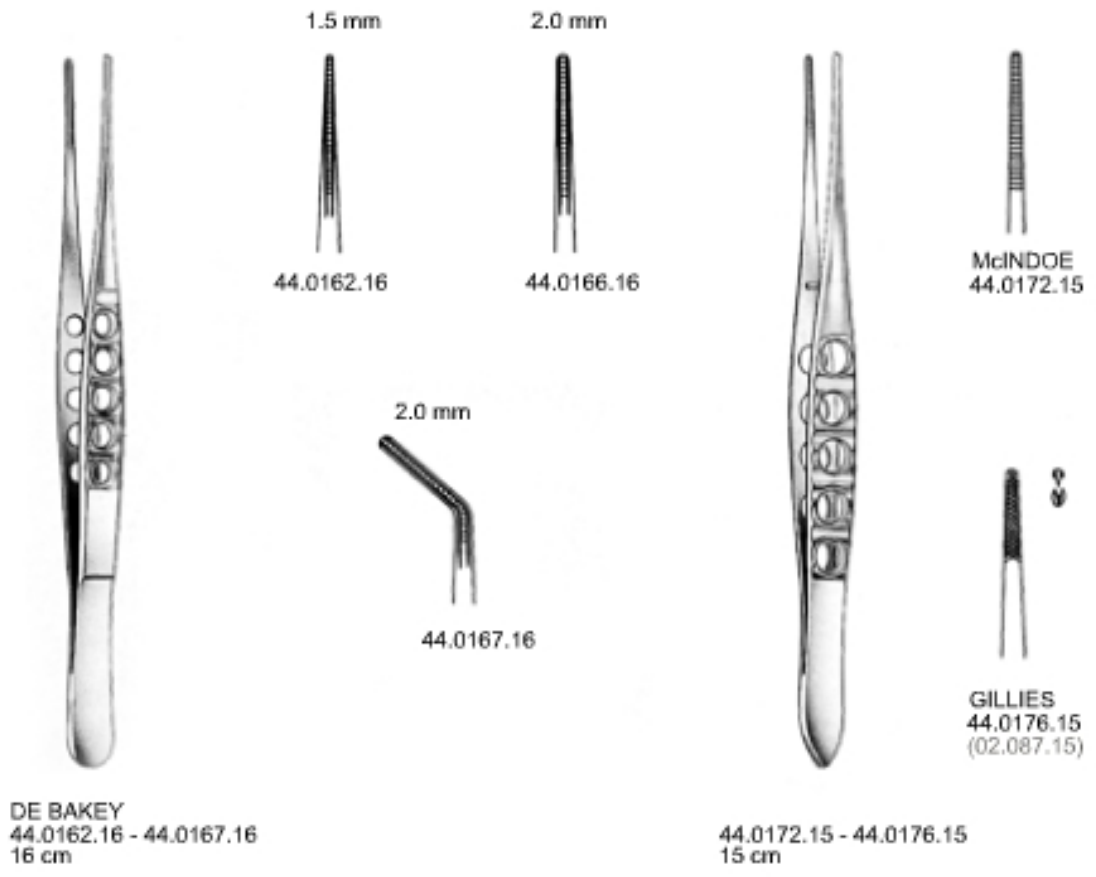



- 44.0204.12 12 cm
- 44.0208.13 13 cm
- 44.0212.14 14.5 cm
- 44.0216.15 15.5 cm
- 44.0220.18 18 cm
- 44.0224.21 21 cm
- 44.0228.25 25 cm
- 44.0232.31 31 cm

MODELL USA
 44.0204.12 - 44.0232.31
 (02.051.00)



- 44.0236.12 12 cm
- 44.0240.13 13 cm
- 44.0244.14 14.5 cm
- 44.0248.15 15.5 cm
- 44.0252.18 18 cm
- 44.0256.21 21 cm
- 44.0260.25 25 cm
- 44.0264.31 31 cm

MODELL USA
 44.0236.12 - 44.0264.31
 (02.172.00)



- 44.0268.12 12 cm
- 44.0272.13 13 cm
- 44.0276.14 14.5 cm
- 44.0280.15 15.5 cm
- 44.0284.18 18 cm
- 44.0288.21 21 cm
- 44.0292.25 25 cm
- 44.0296.31 31 cm

MODELL USA
 44.0268.12 - 44.0296.31



- 44.0300.12 12 cm
- 44.0304.13 13 cm
- 44.0308.14 14.5 cm
- 44.0312.15

MODELL USA
 44.0300.12 - 44.0312.15
 narrow
 schmal
 estrechas



- 44.0316.12 12 cm
- 44.0320.13 13 cm
- 44.0324.14 14.5 cm

MODELL USA
 44.0316.12 - 44.0324.14
 narrow
 schmal
 estrechas

Dressing Forceps
Anatomische Pinzetten
Pinzas de disección



STANDARD
44.0328.10 - 44.0360.30
(02.146.00)



44.0328.10
10.5 cm



44.0332.11
11.5 cm



44.0336.13
13.0 cm



44.0340.14
14.5 cm



44.0344.16
16.0 cm



44.0348.18
18.0 cm



44.0352.20
20.0 cm



44.0356.25
25.0 cm



44.0360.30
30.0 cm

Dressing Forceps, Tissue Forceps
Anatomische Pinzetten, Chirurgische Pinzetten
Pinzas de disección, Pinzas de disección con dientes

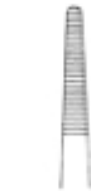

- 44.0364.10 10.5 cm
- 44.0368.11 11.5 cm
- 44.0372.13 13.0 cm
- 44.0376.14 14.5 cm
- 44.0380.16 16.0 cm
- 44.0384.18 18.0 cm
- 44.0388.20 20.0 cm
- 44.0382.25 25.0 cm
- 44.0396.30 30.0 cm

44.0364.10 - 44.0396.30
narrow
schmal
estrechas



- 44.0365.10 10.5 cm
- 44.0369.11 11.5 cm
- 44.0373.13 13.0 cm
- 44.0377.14 14.5 cm
- 44.0381.16 16.0 cm
- 44.0385.18 18.0 cm
- 44.0389.20 20.0 cm
- 44.0383.25 25.0 cm
- 44.0397.30 30.0 cm

44.0365.10 - 44.0397.30
narrow
schmal
estrechas

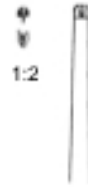

- 44.0400.10 10.5 cm
- 44.0404.11 11.5 cm
- 44.0408.13 13.0 cm
- 44.0412.14 14.5 cm
- 44.0416.16 16.0 cm
- 44.0420.18 18.0 cm
- 44.0424.20 20.0 cm
- 44.0428.25 25.0 cm
- 44.0432.30 30.0 cm

44.0400.10 - 44.0432.30
narrow
schmal
estrechas



- 44.0401.10 10.5 cm
- 44.0405.11 11.5 cm
- 44.0409.13 13.0 cm
- 44.0413.14 14.5 cm
- 44.0417.16 16.0 cm
- 44.0421.18 18.0 cm
- 44.0425.20 20.0 cm
- 44.0429.25 25.0 cm
- 44.0433.30 30.0 cm

12
44.0401.10 - 44.0433.30



- 44.0436.13 13.0 cm
- 44.0440.14 14.5 cm

44.0436.13 - 44.0440.14
delicate
fein
finas



- 44.0444.13 13.0 cm
- 44.0448.14 14.5 cm

12
44.0444.13 - 44.0448.14
delicate
fein
finas

Tissue Forceps
 Chirurgische Pinzetten
 Pinzas de disección con dientes

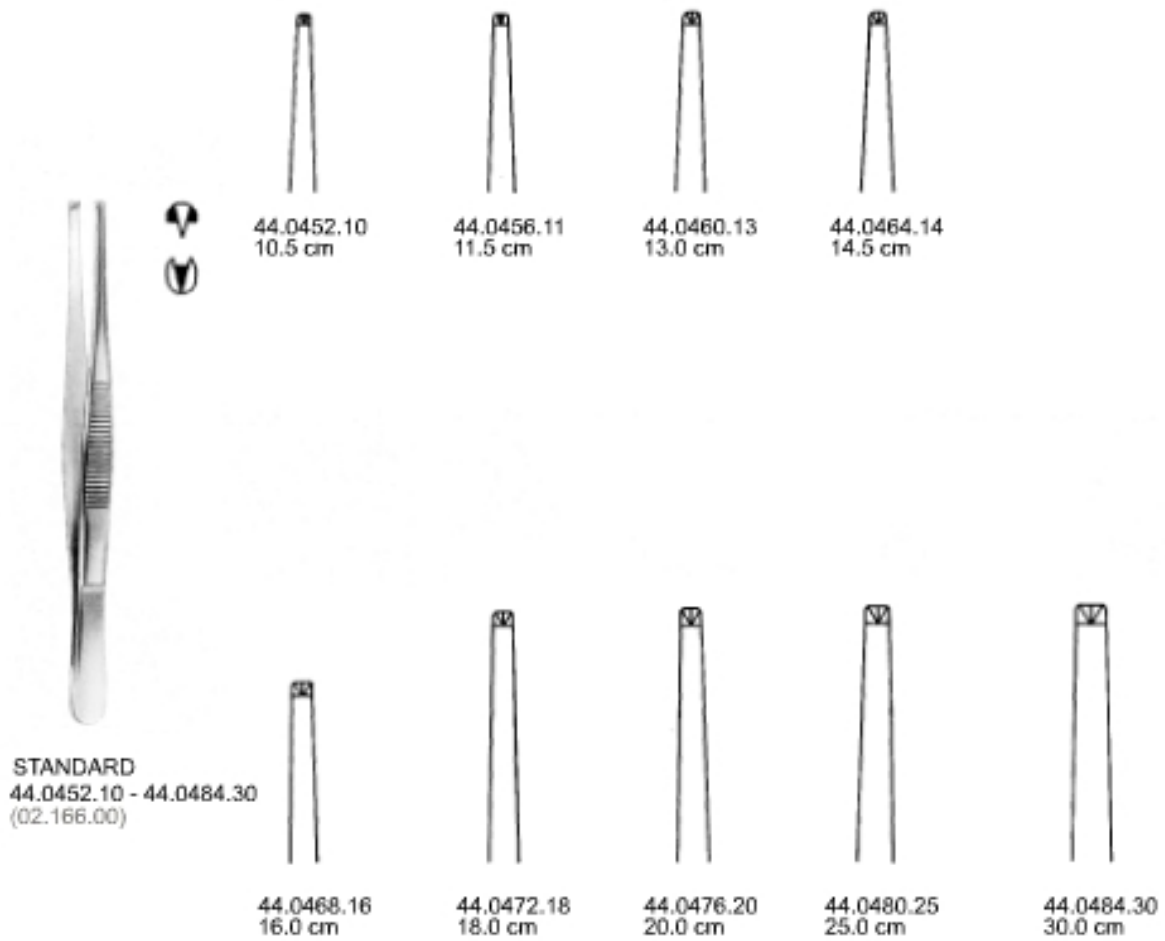

44

Tissue Forceps
Chirurgische Pinzetten
Pinzas de disección con dientes



44.0488.1313 cm
44.0492.1414 cm
44.0496.1616 cm

44.0488.13 - 44.0496.16
(02.171.00)

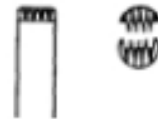

44.0500.1313 cm
44.0504.1414 cm
44.0508.1616 cm

44.0500.13 - 44.0508.16
(02.170.00)



44.0512.1313 cm
44.0516.1414 cm
44.0520.1616 cm
44.0524.1818 cm
44.0528.2020 cm
44.0532.2525 cm
44.0536.3030 cm

44.0512.13 - 44.0536.30
(02.167.00)

Dressing Forceps, Tissue Forceps
 Anatomische Pinzetten, Chirurgische Pinzetten
 Pinzas de disección, Pinzas de disección con dientes

44



MODELL USA
 44.0540.14
 14 cm



MODELL USA
 44.0544.14
 14 cm



ADSON
 44.0548.12
 12 cm



GRUENWALD (JANSEN)
44.0552.20
20 cm



GRUENWALD
44.0556.20
20 cm



JACKSON
44.0561.22 - 44.0563.22
22 cm



KUEHNE
44.0564.10
10.5 cm



KUEHNE
44.0569.10
10.5 cm

Cilia Forceps
Cilienpinzetten
Pinzas depilatorias

44



DOUGLAS
44.0572.09
9 cm



BEER
44.0576.09
9 cm



LITTAUER
44.0580.08
8.5 cm



44.0583.09
9 cm

44

Cilia Forceps
Cilienpinzetten
Pinzas depilatorias



BARRAQUER
44.0587.10
10.5 cm



GRADLE
44.0591.09
9.5 cm



ZIEGLER
44.0594.09
9 cm

Splinter Forceps
Splitter - Pinzetten
Pinzas para espinas



44.0598.07 7.5 cm
43.0602.09 9 cm
43.0606.11 11 cm
(02.178.08)

FEILCHENFELD
44.0598.07 - 44.0606.11



WALTER-CARMALT
44.0610.10
10.5 cm



WALTER-CARMALT
44.0615.10
10.5 cm



HUNTER
44.0618.10
10.5 cm



HUNTER
44.0621.10
10.5 cm

44

Splinter Forceps
Splitter - Pinzetten
Pinzas para espinas



44.0624.08 8 cm
44.0628.09 9 cm
44.0632.10 10.5 cm
44.0636.11 11.5 cm
44.0642.12 12.5 cm
44.0646.14 14.5 cm
(02.176.08)



44.0649.08 8 cm
44.0653.09 9 cm
44.0657.10 10.5 cm
44.0661.11 11.5 cm
44.0665.12 12.5 cm
44.0669.14 14.5 cm



44.0672.08 8 cm
44.0676.09 9 cm
44.0680.10 10.5 cm
44.0684.11 11.5 cm
44.0688.12 12.5 cm
44.0692.14 14.5 cm



44.0695.08 8 cm
44.0699.09 9 cm
44.0703.10 10.5 cm
44.0707.11 11.5 cm
44.0711.12 12.5 cm
44.0715.14 14.5 cm

Splinter Forceps
Splitter - Pinzetten
Pinzas para espinas

44



44.0718.08 8 cm
44.0722.09 9 cm
44.0726.10 10.5 cm
44.0730.11 11.5 cm
44.0734.12 12.5 cm
44.0738.14 14.5 cm



44.0741.08 8 cm
44.0745.09 9 cm
44.0749.10 10.5 cm
44.0753.11 11.5 cm
44.0757.12 12.5 cm
44.0761.14 14.5 cm



44.0764.08 8 cm
44.0768.09 9 cm
44.0772.10 10.5 cm
44.0776.11 11.5 cm
44.0780.12 12.5 cm
44.0784.14 14.5 cm



44.0789.08 8 cm
44.0793.09 9 cm
44.0797.10 10.5 cm
44.0801.11 11.5 cm
44.0805.12 12.5 cm
44.0809.14 14.5 cm

44

Dressing Forceps
Anatomische Pinzetten
Pinzas de disección



TAYLOR
44.0850.17
17.5 cm
(02.164.17)



TAYLOR
44.0853.17
17.5 cm



McINDOE
44.0858.15
15 cm
(02.149.15)



44.0624.08 8 cm
44.0628.09 9 cm
44.0632.10 10.5 cm
44.0636.11 11.5 cm
44.0642.12 12.5 cm
44.0646.14 14.5 cm
(02.176.08)



44.0649.08 8 cm
44.0653.09 9 cm
44.0657.10 10.5 cm
44.0661.11 11.5 cm
44.0665.12 12.5 cm
44.0669.14 14.5 cm



44.0672.08 8 cm
44.0676.09 9 cm
44.0680.10 10.5 cm
44.0684.11 11.5 cm
44.0688.12 12.5 cm
44.0692.14 14.5 cm



44.0695.08 8 cm
44.0699.09 9 cm
44.0703.10 10.5 cm
44.0707.11 11.5 cm
44.0711.12 12.5 cm
44.0715.14 14.5 cm

Dressing Forceps
Anatomische Pinzetten
Pinzas de disección

44



CUSHING
44.0902.17
17.5 cm
(02.159.17)



CUSHING
44.0905.17
17.5 cm
(02.160.17)

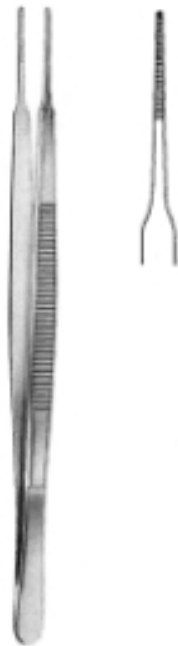

GERALD
44.0908.18
18 cm



GERALD
44.0913.18
18 cm

44

Dressing Forceps
Anatomische Pinzetten
Pinzas de disección



44.0916.18 18 cm
44.0920.21 21 cm
44.0924.25 25 cm

POTTS-SMITH
44.0916.18 - 44.0924.25



44.0929.18 18 cm
44.0933.21 21 cm
44.0937.25 25 cm

POTTS-SMITH
44.0929.18 - 44.0937.25



BROPHY
44.0942.20
20 cm



BROPHY
44.0945.20
20 cm

Tissue Forceps
 Chirurgische Pinzetten
 Pinzas de disección con dientes



44.0948.18 18 cm
 44.0952.21 21 cm
 44.0956.25 25 cm

POTTS-SMITH
 44.0948.18 - 44.0956.25



44.0959.18 18 cm
 44.0963.21 21 cm
 44.0965.25 25 cm

POTTS-SMITH
 44.0959.18 - 44.0965.25



BROPHY
 44.0968.20
 20 cm



BROPHY
 44.0971.20
 20 cm

44

Dressing Forceps, Tissue Forceps
Anatomische Pinzetten, Chirurgische Pinzetten
Pinzas de disección, Pinzas de disección con dientes



DUEHRSSEN
44.0974.20
20 cm



DUEHRSSEN
44.0978.20
20 cm



DUEHRSSEN
44.0982.20
20 cm



DUEHRSSEN
44.0986.20
20 cm



BROWN
44.0992.15 - 44.1000.25

44.0992.1515 cm
44.0996.2121 cm
44.1000.2525 cm

Dressing Forceps, Tissue Forceps
 Anatomische Pinzetten, Chirurgische Pinzetten
 Pinzas de disección, Pinzas de disección con dientes



44.1004.11 11 cm
 44.1008.13 13 cm
 44.1012.15 15 cm

STILLE
 44.1004.11-44.1012.15



STILLE
 44.1016.15
 15 cm
 (02.173.15)



STILLE
 44.1020.15
 15 cm
 (02.174.15)



44.1024.15 15 cm
 44.1028.20 20 cm

ADLERKREUTZ
 44.1024.15 - 44.1028.20
 2:3 teeth - zahne - dientes



44.1032.15 15 cm
 44.1036.20 20 cm
 44.1040.25 25 cm

ADLERKREUTZ
 44.1032.15 - 44.1040.25
 4:5 teeth - zahne - dientes

44

Tissue Forceps, Grasping Forceps
Chirurgische Pinzetten, Faßpinzetten
Pinzas de disección con dientes, Pinzas para coger



BONNEY
44.1044.18
18 cm
teeth-zahne-dientes

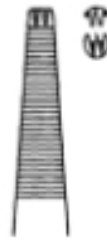

BONNEY
44.1048.18
18 cm
teeth-zahne-dientes



MAYO-RUSS
44.1052.23
23 cm



SINGLEY-TUTTLE
44.1056.23
23 cm

Tissue Forceps, Grasping Forceps
 Chirurgische Pinzetten, Faßpinzetten
 Pinzas de disección con dientes, Pinzas para coger



44.1060.20



44.1064.20



44.1068.20

COLLIN-DUVAL
 44.1060.20 - 44.1068.20
 20 cm



44.1072.10
 Fig-1



44.1075.10
 Fig-2



44.1079.10
 Fig-3

44.1072.10 - 44.1079.10
 10.5 cm



44.1082.10
 Fig-1



44.1085.10
 Fig-2



44.1089.10
 Fig-3

44.1082.10-44.1089.10
 10.5 cm
 1:2 teeth-zahne-dientes



WANGENSTEEN
44.1092.23
23 cm



STILLE-BARRAYA
44.1096.18 - 44.1104.25
3:4 teeth-zahne-dientes



44.1096.18 18 cm
44.1100.20 20 cm
44.1104.25 25 cm



FERRIS-SMITH
44.1108.18
18 cm



NELSON
44.1112.23
23 cm



Dressing Forceps, Tissue Forceps
Anatomische Pinzetten, Chirurgische Pinzetten
Pinzas de disección, Pinzas de disección con dientes

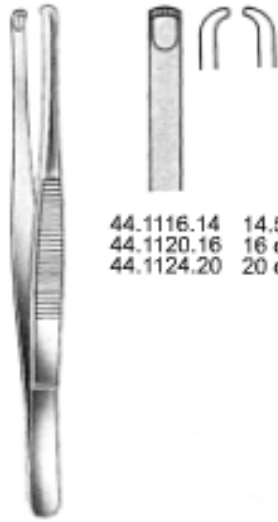

44.1116.14 14.5 cm
44.1120.16 16 cm
44.1124.20 20 cm

DURANTE
44.1116.14 - 44.1124.20



DUVAL
44.1128.14
14.5 cm

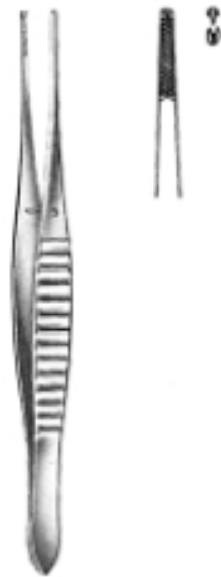

GILLIES
44.1132.15
15 cm



44.1136.15 15 cm
44.1140.20 20 cm
44.1144.25 25 cm

RUSS. MODELL
44.1136.15 - 44.1144.25

44

Jeweler's Forceps
Uhrmacherpinzetten
Pinzas de relojero



44.1149.24 44.1153.24
∅3 mm ∅3 mm

SAMII
44.1149.24 - 44.1153.24
24 cm



44.1157.24
∅ 5.0 mm

HUNT
44.1157.20
20 cm

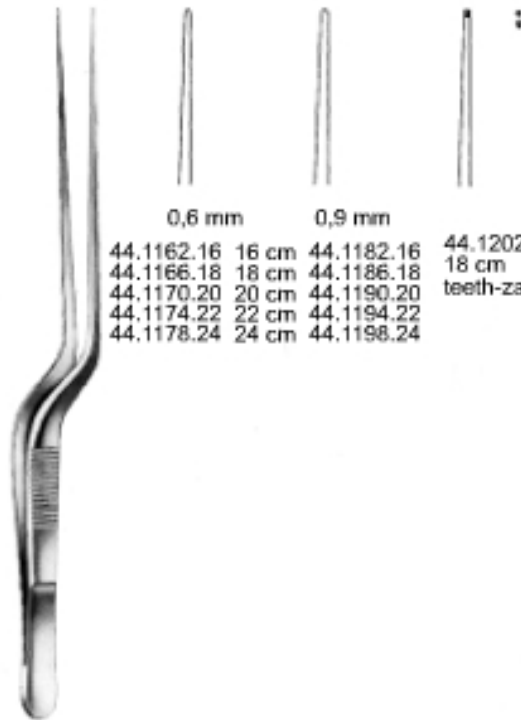

	0,6 mm	0,9 mm	44.1202.18
44.1162.16	16 cm	44.1182.16	18 cm
44.1166.18	18 cm	44.1186.18	teeth-zahne-dientes
44.1170.20	20 cm	44.1190.20	
44.1174.22	22 cm	44.1194.22	
44.1178.24	24 cm	44.1198.24	

HUNT
44.1162.16 - 44.1202.18

Jeweler's Forceps
Uhrmacherpinzetten
Pinzas de relojero

44

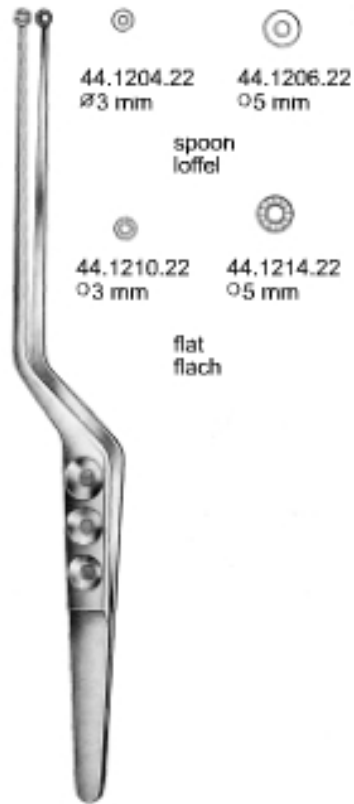

YASARGIL
44.1204.22 - 44.1214.22
22 cm



HEIFETZ
44.1218.22 - 44.1222.22
22 cm



1/1

44.1226.11
11 cm



1/1

44.1230.11
11 cm



1/1

44.1234.12
12 cm



1/1

44.1236.12
12 cm



1/1

44.1240.12
12 cm



1/1
44.1243.10
11.5 cm



1/1
44.1247.10
10.5 cm



1/1
44.1251.11
10.5 cm



1/1
44.1254.11
11.0 cm

TC GOLD



CUSHING
 44.1258.17 - 44.1261.18
 17.5 cm



CUSHING-TAYLOR
 44.1264.18
 18 cm

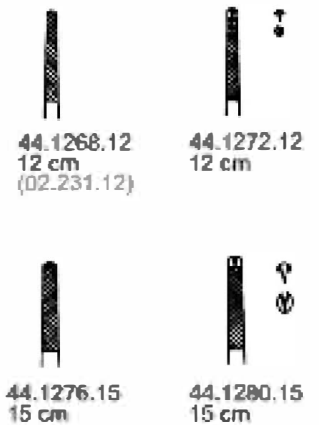

ADSON
 44.1268.12 - 44.1280.15

Dissecting Forceps with Tungsten Carbide Inserts
 Pinzetten mit Härmetalleinsätzen
 Pinzas de disección con bocas de carburo de tungsteno

TC GOLD

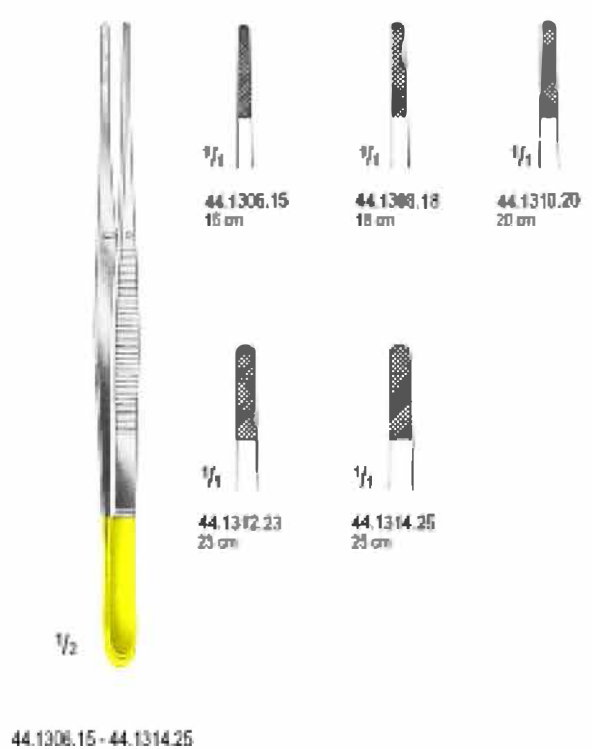
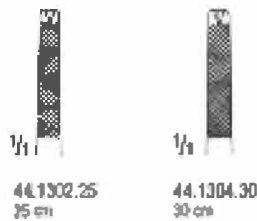
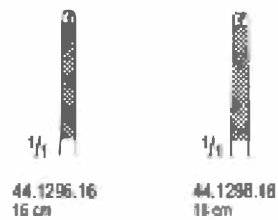
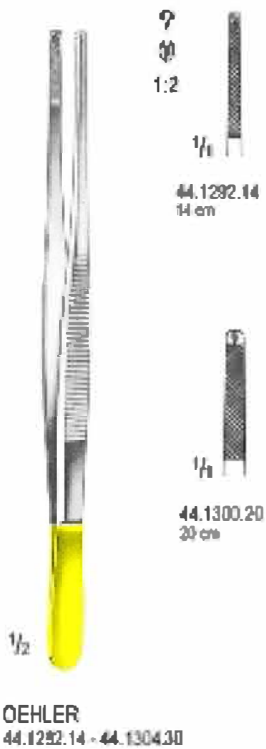
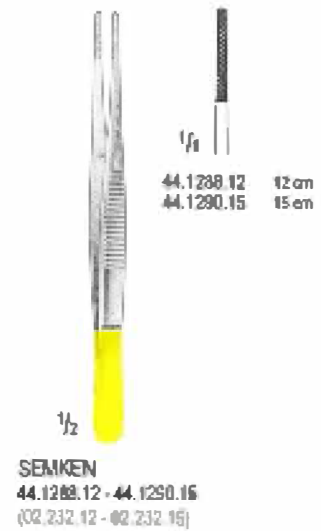

TC GOLD

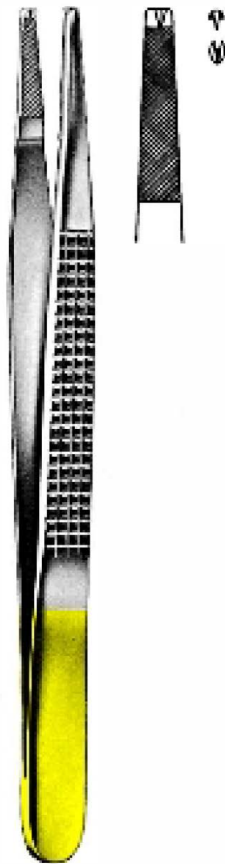

BONNEY
 44.1320.18
 18 cm



WANGENSTEEN
 44.1324.15 - 44.1328.23



44.1324.15
 15 cm



44.1328.23
 23 cm



DE BAKEY
 44.1332.16 - 44.1352.24

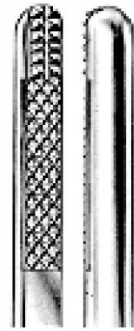

1.5 mm

2.0 mm

44.1332.16	16 cm	44.1344.16	16 cm
44.1336.20	20 cm	44.1348.20	20 cm
44.1340.24	24 cm	44.1352.24	24 cm



Ophthalmology



Capsular Forceps
Kapselpinzetten
Pinzas Capsular

45



ARRUGA
45.0103.10
10 cm



ARRUGA
45.0107.10
10 cm



TERSON
45.0111.09
9 cm



CASTROVIEJO
45.0115.10
10 cm



CASTROVIEJO
45.0119.10
10 cm



BINKHORST
45.0123.07
7 cm



GILL-FUCHS
45.0127.07
7.5 cm



MOD-BONN
45.0130.07
1:2 teeth-zahne-dientes
7 cm



MOD-BONN
45.0134.07
1:2 teeth-zahne-dientes
7 cm



BARRAQUER-KATZIN
(Colibri)
45.0137.07
1:2 teeth-zahne-dientes
7 cm



TROUTMAN
(Corneal)
45.0141.07
1:2 teeth-zahne-dientes
7 cm



BARRAQUER-KATZIN
(Colibri)
45.0145.07
1:2 teeth-zahne-dientes
7.5 cm

Iris Forceps
Irispinzetten
Pinzas Para Iris

45



45.0149.07
teeth onside
zahne seitwärts
dientes laterales



45.0153.07
teeth below
zahne unten
dientes inferiores

GILL-HESS
45.0149.07-45.0153.07
7.5 cm



HESS
45.0157.07
7 cm



HESS
45.0161.09
9 cm

45

Iris Forceps
Irispinzetten
Pinzas Para Iris



GRAEFE
45.0164.07 - 45.0205.10



Fig-1

45.0164.07 7 cm
45.0168.10 10 cm



Fig-2

45.0171.07 7 cm
45.0175.10 10 cm



Fig-3

45.0179.07 7 cm
45.0181.10 10 cm



Fig-4

45.0186.07 7 cm
45.0190.10 10 cm



Fig-5

45.0193.07 7 cm
45.0197.10 10 cm



Fig-6

45.0201.07 7 cm
45.0205.10 10 cm



GRAEFE
45.0208.05 - 45.0216.10
7 cm



45.0208.05 0.5 mm
45.0212.07 0.7 mm
45.0216.10 1.0 mm



GRAEFE
45.0209.05 - 45.0217.10
7 cm



45.0209.05 0.5 mm
45.0213.07 0.7 mm
45.0217.10 1.0 mm



GRAEFE
45.0220.05 - 45.0228.10
7 cm



45.0220.05 0.5 mm
45.0224.07 0.7 mm
45.0228.10 1.0 mm



GRAEFE
45.0221.05 - 45.0229.10
7 cm



45.0221.05 0.5 mm
45.0225.07 0.7 mm
45.0229.10 1.0 mm

Iris Forceps
Irispinzetten
Pinzas Para Iris



STEVENS
45.0232.10 - 45.0245.10
10.5 cm



45.0232.10
Fig-1



45.0233.10
Fig-2



45.0237.10
Fig-3



45.0240.10
Fig-1



45.0241.10
Fig-2



45.0245.10
Fig-3



FISCHER-ARLT
45.0249.07
7 cm



STEVENS
45.0252.11
11 cm



STEVENS
45.0253.11
11 cm

Iris Forceps
Irispinzetten
Pinzas Para Iris

45



FOERSTER
45.0274.08
8.5 cm



FOERSTER
45.0275.08
8.5 cm



FOERSTER



FOERSTER

Iris Forceps
Irispinzetten
Pinzas Para Iris

45



FOERSTER
45.0274.08
8.5 cm



FOERSTER
45.0275.08
8.5 cm



FOERSTER
45.0278.08
8.5 cm



FOERSTER
45.0279.08
8.5 cm

45

Suture Forceps
Nahtpinzetten
Pinzas Para Sutura



ST.MARTIN
45.0282.07
7 cm



DESMARRES
45.0286.09 - 45.0294.09
9 cm



45.0286.09
Fig-1



45.0290.09
Fig-2



45.0294.09
Fig-3

Suture Forceps
Nahtpinzetten
Pinzas Para Sutura

45



AYER
45.0298.09
9 cm



AYER
45.0302.09
9 cm



45.0306.10 0.12 mm
45.0310.10 0.30 mm
45.0314.10 0.50 mm
45.0318.10 1.0 mm
45.0322.10 1.5 mm

CASTROVIEJO
45.0306.10 - 45.0322.10
10 cm



45.0307.10 0.12 mm
45.0311.10 0.30 mm
45.0315.10 0.50 mm
45.0319.10 1.0 mm
45.0323.10 1.5 mm

CASTROVIEJO
45.0307.10 - 45.0323.10
10 cm

45

Mascular Forceps
Mascularpinzetten
Pinzas Masculars



SATTLER
45.0327.10
10 cm



SATTLER
45.0331.10
10 cm



BLASCOVICS
45.0335.09
9 cm



BLASCOVICS
45.0339.09
9 cm

Mascular Forceps
Mascularpinzetten
Pinzas Masculars

45



BONACCOLTO
45.0342.10
10 cm



BONACCOLTO
45.0346.10
10 cm



MOD-TÜBINGEN
45.0350.10
10 cm



PAUFIGUE
45.0354.10
10 cm



ERHARDT
45.0358.09
9 cm

45

Fixation Forceps
Fixier Pinzetten
Pinzas de Fijacion



45.0362.09



45.0363.09

CASTROVIEJO
45.0362.09 - 45.0363.09
9 cm



45.0366.09



1:2



45.0370.09



2:3

LESTER
45.0366.09 - 45.0370.09
9 cm



v₁

MOORFIELD
45.0374.10
10 cm

Fixation Forceps
Fixier Pinzetten
Pinzas de Fijacion

45



45.378.11
with spring catch
mit schlob
concierre de resorte

45.382.11
without spring catch
ohne schlob
sin cierre de resorte

GRAEFE
45.0378.11 - 45.0382.11
11 cm



ELSCHING
45.0386.11
11 cm



ELSCHING
45.0390.11
11 cm



ELSCHING
45.0394.11
11 cm

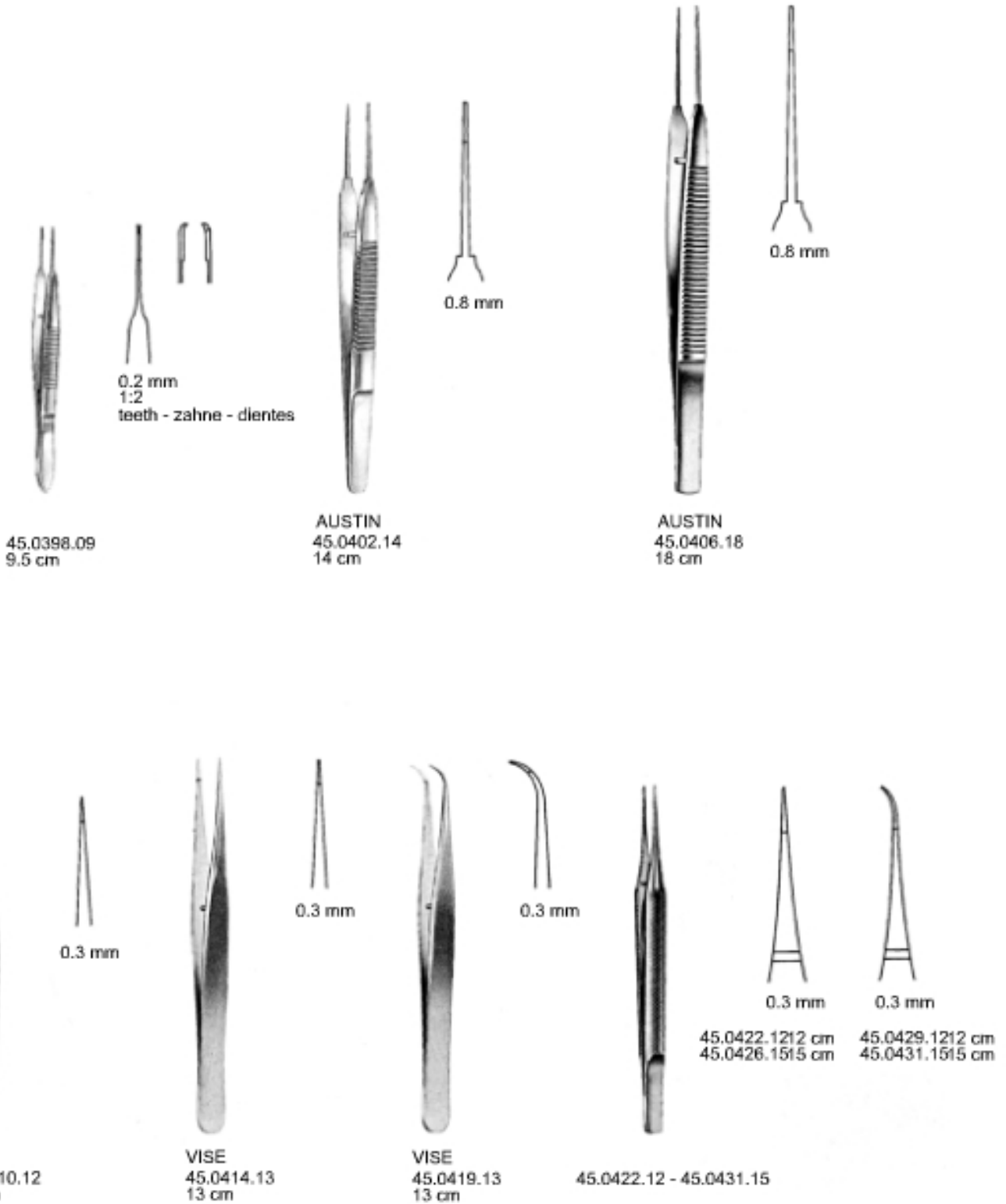

Micro Forceps with platform
Mikro - Pinzetten mit Plateau
Micro - Pinzas con plataforma

45



45.0435.11
11 cm



45.0438.14
14 cm



45.0442.14
14 cm

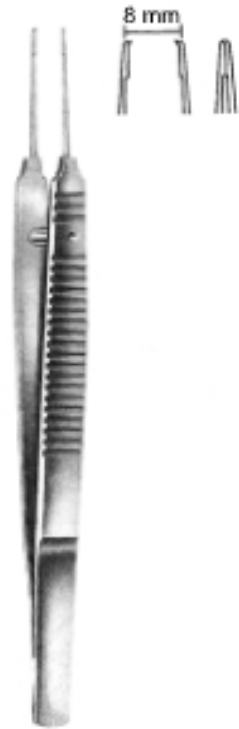

45.0446.14
14 cm



45.0450.18



45.0453.18

45.0450.18 - 45.0453.18
18 cm

45

Micro Scissors
Mikroscheren
Micro Tijeras



WESTCOTT
45.0457.12
12 cm
curved-gebogen-curved



WESTCOTT
45.0462.11
11.5 cm
straight-gerade-recta



WESTCOTT
45.0465.11
11.5 cm
curved-gebogen-curved



NOYES
45.0468.15
15 cm

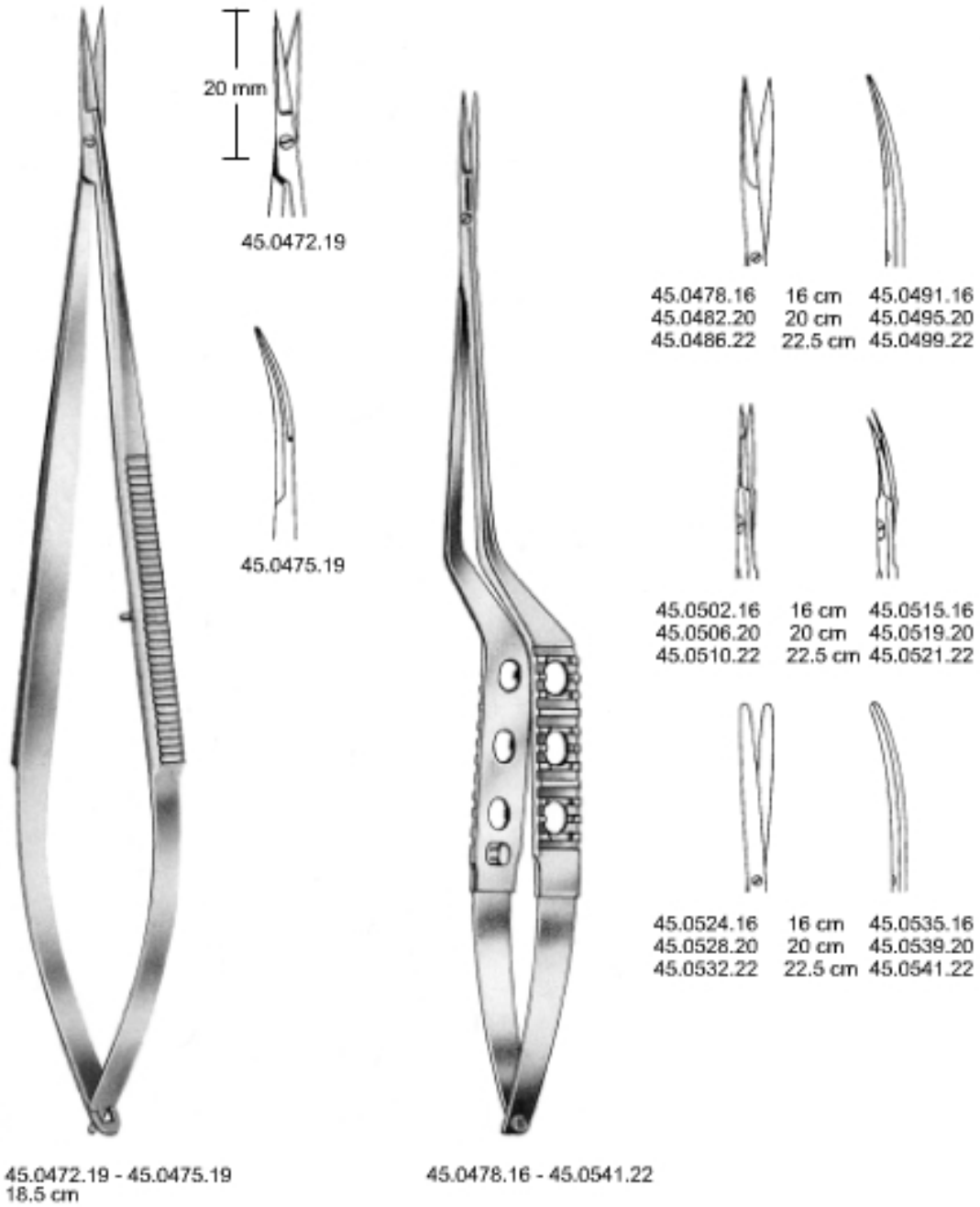

45

Micro Scissors
Mikroscheren
Micro Tijeras



45.0545.18
25°



45.0553.18
45°



45.0561.18
60°



45.0567.18
90°

45.0545.18 - 45.0567.18
18 cm



45.0571.18
25°



45.0575.18
45°



45.0579.18
60°



45.0583.18
90°

45.0571.18 - 45.0583.18
18 cm



45.0586.15 - 45.0595.15
15 cm

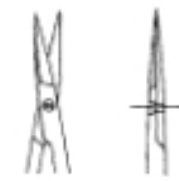

45.0586.15
adventitia



45.0587.15
dissection



45.0590.15
adventitia



45.0591.15
dissection



45.0594.15
adventitia



45.0595.15
dissection



45.0598.11 - 45.0599.11
11 cm



45.0598.11
adventitia



45.0599.15
dissection



NOYES
45.0602.12 - 45.0610.12
12 cm



45.0602.12
Fig-1



45.0606.12
Fig-2



45.0610.12
Fig-3



NOYES
45.0625.12 - 45.0633.12
12 cm

45.0625.12 Fig-1
45.0629.12 Fig-2
45.0633.12 Fig-3

angle - kniegebogen - acodada



WECKER
45.0637.11 - 45.0645.11
11 cm



45.0637.11
Fig-1



45.0641.11
Fig-2



45.0645.11
Fig-3



BARRAQUER
45.0649.05 5 mm
45.0653.07 7 mm
45.0657.10 10 mm
5.5 cm



45.0660.10
10 cm



45.0665.10
10 cm



KATZIN
45.0669.11
11 cm



KATZIN
45.0673.11
11 cm

45

Micro Scissors
Mikroscheren
Micro Tijeras



KATZIN-BARRAQUER
45.0677.10
10 cm



KATZIN-BARRAQUER
45.0681.10
10 cm



KATZIN
45.0685.10
10 cm



KATZIN
45.0689.10
10 cm

Micro Scissors
Mikroscheren
Micro Tijeras

45

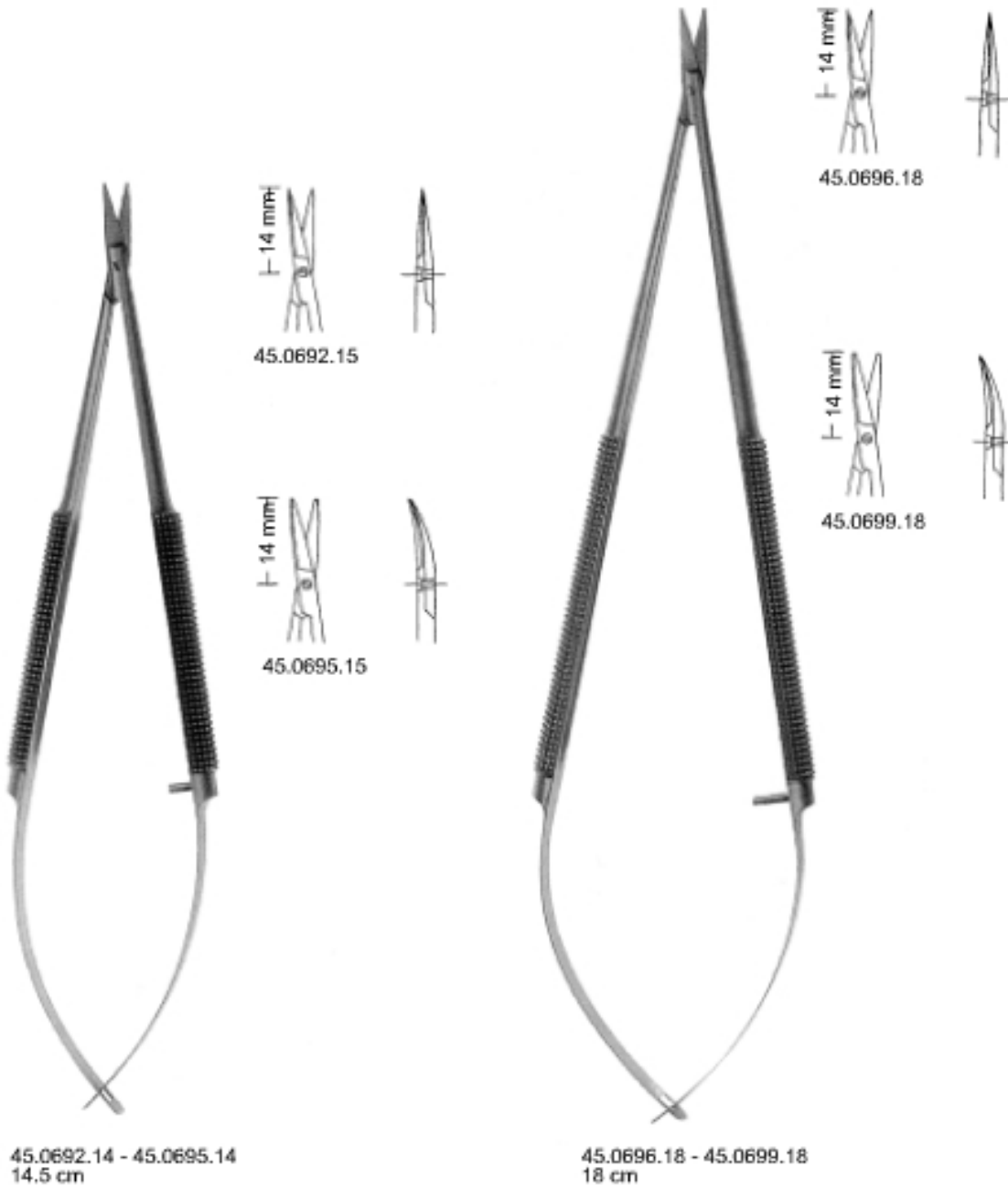

45

Micro Scissors
Mikroscheren
Micro Tijeras

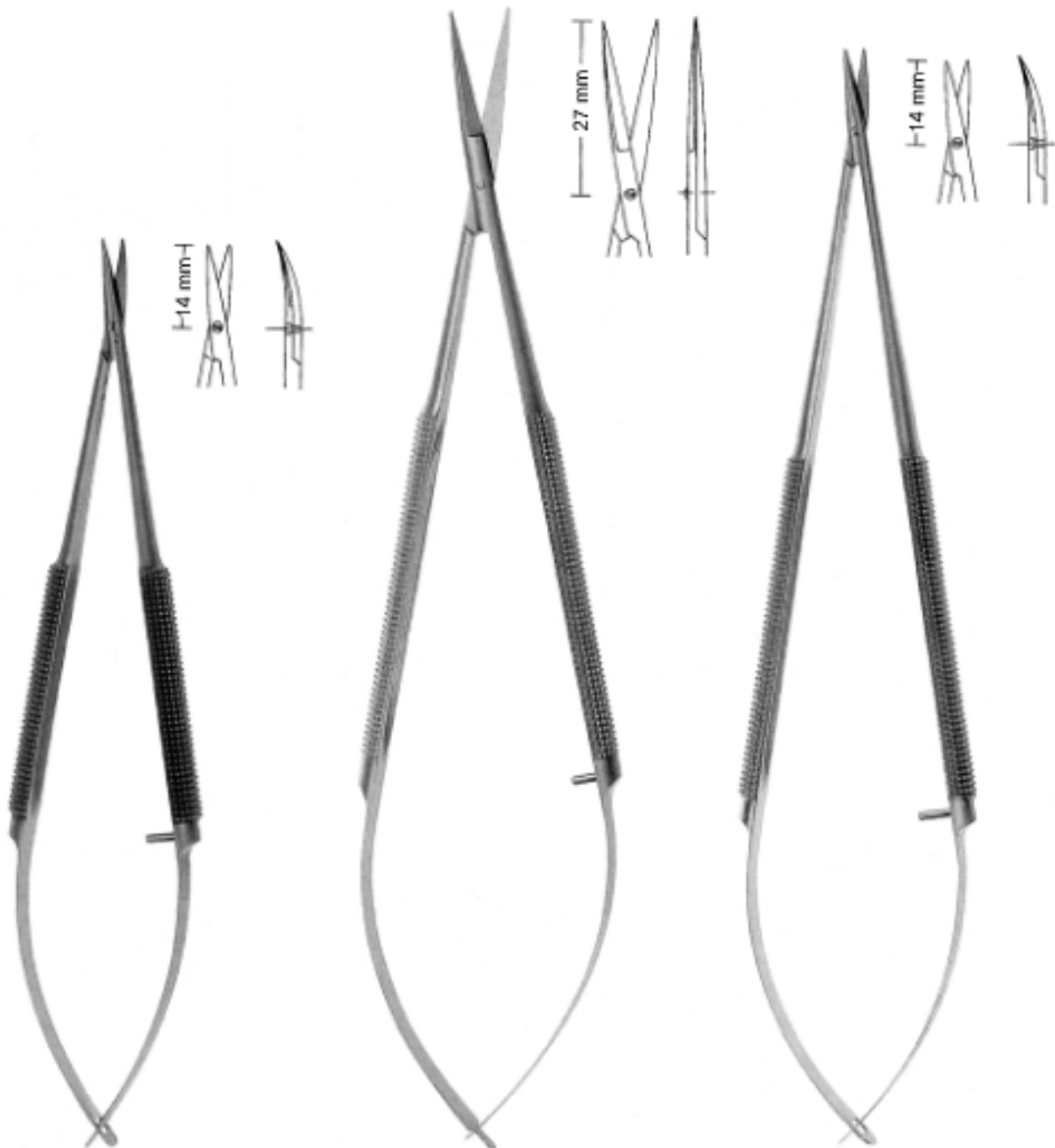

45.0703.14
14.5 cm

45.0708.18
18 cm

45.0711.18
18 cm

Eye Scissors
Augenscheren
Tijeras Oculares

45



45.0715.09
left
links
izquierda

45.0717.09
right
rechts
derecha

AEBLI
45.0715.09 - 45.0718.09
9.5 cm
angle-abgewinkelt-acodad



45.0721.09
left
links
izquierda

45.0725.09
right
rechts
derecha

MC GUIRE
45.0721.09 - 45.0725.09
9.5 cm



45.0729.10
(16.300.11)

45.0733.10
serrated
gezahnt
dentadas

La Grange
45.0729.11 - 45.0733.11
11.5 cm



45.0737.12

45.0741.12

Landolt
45.0737.12 - 45.0741.12
12 cm



VANNAS
45.0748.08
8 cm
straight
gerade
recta



VANNAS
45.0751.08
8 cm
curved
gebogen
curvas



VANNAS
45.0755.08
8 cm
angular
kniegebogen
acodadas

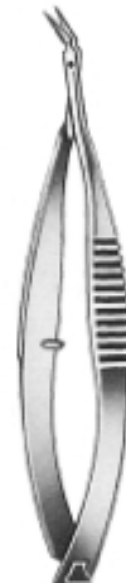

VANNAS
45.0759.08
8 cm
angled on flat
aufgewinkelt
acodadas hacia arriba



45.0762.08
8.5 cm
straight-gerade-recta



45.0765.08
8.5 cm
curved-gebogen-curvas



45.0769.08
8.5 cm
angular-kniegebogen-acodadas



45.0773.08
8.5 cm
angular-kniegebogen-acodadas

VANNAS, SPECIAL MODEL

Tenotomy Scissors
Sehnenscheren
Tijera Para Tenotomia Y Cornea



CASTROVIEJO
45.0778.09 - 45.0789.09
9 cm



45.0778.09
blunt-stumpf-romo



45.781.09
blunt-stumpf-romo



45.785.09
blunt-stumpf-romo



45.789.09
sharp-scharf-agudo



CASTROVIEJO
45.0793.10
10 cm



sharp
scharf
agudo



CASTROVIEJO
45.0797.10
10 cm



blunt
stumpf
romo

45

Tenotomy Scissors
Sehnscheren
Tijera Para Tenotomia Y Cornea



TROUTMAN
45.0801.10
10 cm



TROUTMAN
45.0805.10
10 cm



CASTROVIEJO
45.0809.11
11 cm



CASTROVIEJO
45.0813.11
11 cm

Cyclodialysis Spatulas
 Zyklodialyse Spatel
 Espatulas Para Ciclodialisis

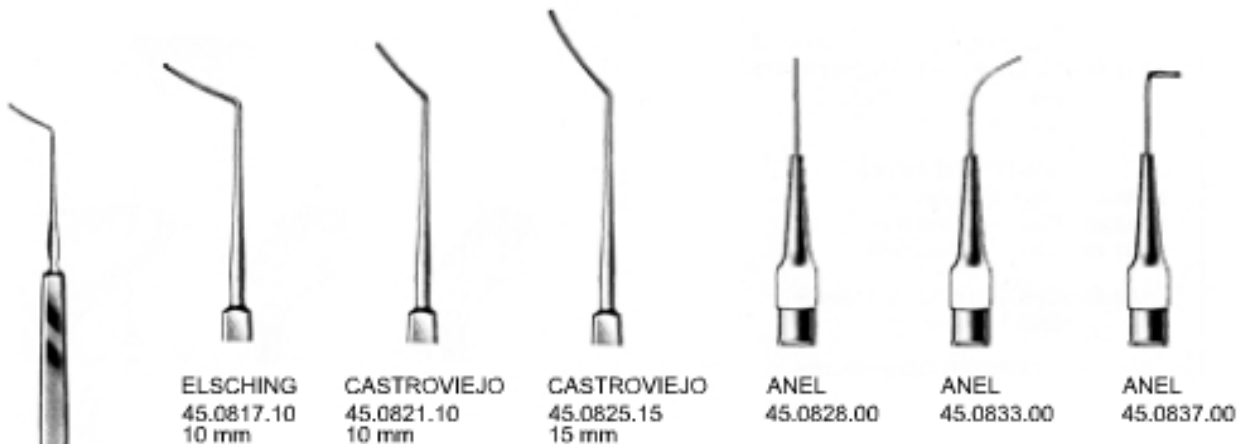

ELSCHING 45.0817.10 10 mm
 CASTROVIEJO 45.0821.10 10 mm
 CASTROVIEJO 45.0825.15 15 mm
 ANEL 45.0828.00
 ANEL 45.0833.00
 ANEL 45.0837.00

45.0817.10 - 45.0837.15

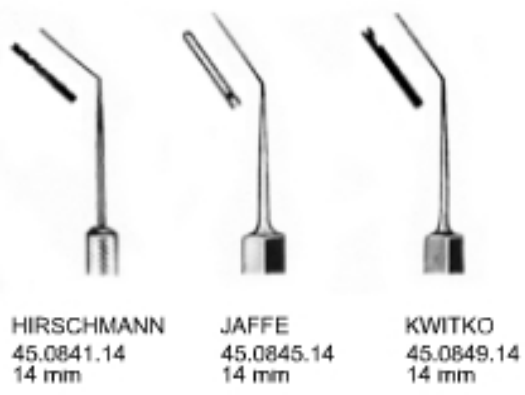

HIRSCHMANN 45.0841.14 14 mm
 JAFFE 45.0845.14 14 mm
 KWITKO 45.0849.14 14 mm



BANGERTER 45.0853.14 14 cm

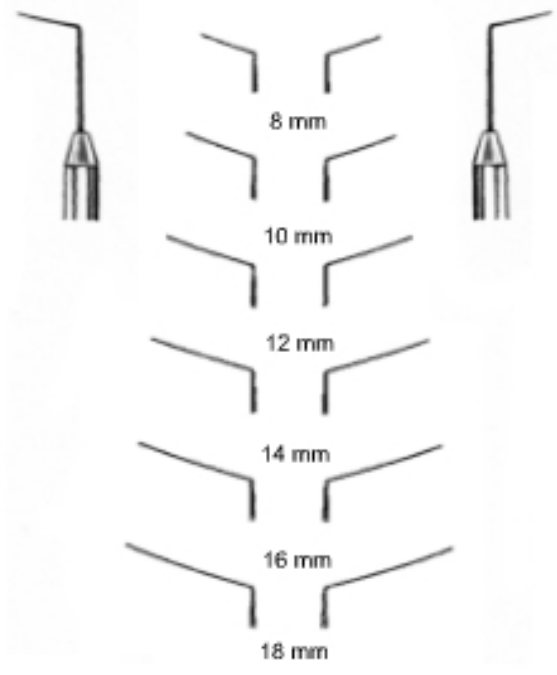

CASTROVIEJO-BARRAQUER
 45.0855.08 8 mm 45.0867.08
 45.0857.10 10 mm 45.0869.10
 45.0859.12 12 mm 45.0871.12
 45.0861.14 14 mm 45.0873.14
 45.0863.16 16 mm 45.0875.16
 45.0865.18 18 mm 45.0877.18

45

Lens Expressors Instruments
Linsenexpressoren Instrumente
Instrumentos Para Expresores



3.7 x 2.7 mm
spoon
loffel
chuchar

MEYHOEFER
45.0882.00



WELLS
45.0886.00



CASTROVIEJO
45.0889.00



CASTROVIEJO
45.0893.010.5 x 15 mm
45.0897.020.75 x 15 mm
45.0901.031.0 x 15 mm



WECKER
45.0904.02
2 mm



WECKER
(Wheeler)
45.0907.11
1 mm



SAUTTER
45.0911.12
12 mm



SAUTTER
45.0915.15
15 mm



SAUTTER
45.0919.17
17 mm

Hooks and Hooklets, Retractors
 Haken Und Hakchen, Wundloffel
 Ghancos Y Ganchitos, Separadores



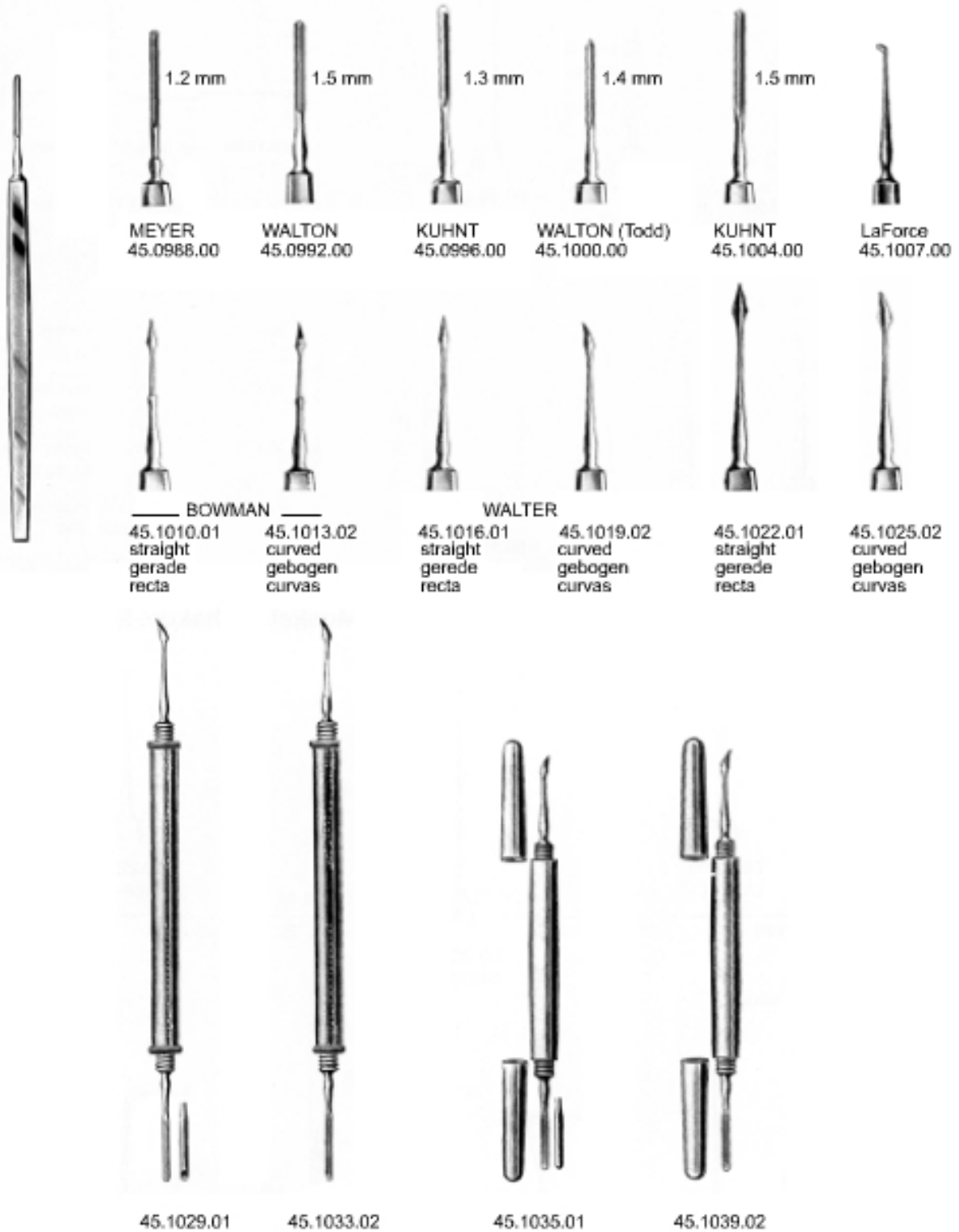

Eye Knives
Augenmesser
Various Chuchillos Para ojo

45



fig- 1

45.1042.01



fig- 2

45.1047.02



fig- 3

45.1051.03

WEBER



GRAEFE
45.1055.00



fig- 1

45.1058.01



fig- 2

45.1062.02



fig- 3

45.1065.03

KUHNT



fig- 4

45.1069.04



PAUFIQUE
45.1073.00



ROLLET
45.1076.00



TOOKE
45.1080.00



BARRAQUER
45.1084.00
7 x 1 mm



GILL
45.1087.00
curved
gebogen
curvas



BARRAQUER
45.1091.00



BARRAQUER
45.1095.03 3 cm
45.1099.04 4 cm



BOWMAN
45.1103.07
7 cm



CRITCHETT
45.1107.07
7 cm



GRAEFE
45.1111.07 7 cm
45.1115.09 9 cm



MULLER
45.1119.07
7 cm



WEISS
45.1123.08
8 cm



WEISS
45.1125.07 7 cm
45.1129.09 9 cm



WEISS
45.1133.07 7 cm
45.1135.09 9 cm



WILLIAMS
45.1139.07 7 cm
45.1143.08 8 cm



CASTROVIEJO
45.1147.08
8 cm



SAUER
45.1151.03
3 cm



LANCASTER
45.1155.07
7 cm



AXENFEILD
45.1159.08
8 cm

Eye Specula
Sperrelevatoren
Blefarrostatos

45



MURDOCK
45.1163.05
5 cm



PLEY
45.1167.06
6 cm



ZIEGLER
45.1171.07
7 cm



MELLINGER
45.1175.05 5 cm
45.1179.07 7 cm



MELLINGER-BEARD
45.1183.05 5 cm
45.1187.07 7 cm



MELLINGER-AXENFELD
45.1191.07
7 cm



MELLINGER-AXENFELD
45.1195.07
7 cm



ARRUGA
45.1199.07
7 cm



ARRUGA
45.1203.07
7 cm



GUYTON-PARK
45.1207.08
8 cm



PARK-MAUMENEE
45.1211.08
8 cm

45

Lid Retractors
Lid Wundhaken
Separadores para parpados



DESMARRES
13 cm



45.1215.01
10 mm
Fig-1



45.1219.02
12 mm
Fig-2



45.1223.03
14 mm
Fig-3



45.1227.04
16 mm
Fig-4



45.1233.05
18 mm
Fig-5



JAEGER
45.1238.00

Lachrymal Probes
Tränenkanal Sonden
Estiletos Para Canal Lacrimal



CALEZOWSKY

- 45.1242.00 Fig-000 0.6 mm
- 45.1246.00 Fig-00 0.7 mm
- 45.1250.00 Fig-0 0.8 mm
- 45.1254.01 Fig-1 0.9 mm
- 45.1258.02 Fig-2 1.1 mm
- 45.1262.03 Fig-3 1.3 mm
- 45.1266.04 Fig-4 1.4 mm
- 45.1270.05 Fig-5 1.5 mm
- 45.1274.06 Fig-6 1.6 mm



BOWMAN

- 45.1278.00 Fig-0000 0.5 mm
- 45.1282.00 Fig-000 0.6 mm
- 45.1286.00 Fig-00 0.7 mm
- 45.1290.00 Fig-0 0.8 mm
- 45.1294.01 Fig-1 0.9 mm
- 45.1298.02 Fig-2 1.1 mm
- 45.1302.03 Fig-3 1.3 mm
- 45.1306.04 Fig-4 1.4 mm
- 45.1310.05 Fig-5 1.5 mm
- 45.1314.06 Fig-6 1.6 mm
- 45.1318.07 Fig-7 1.8 mm
- 45.1322.08 Fig-8 1.9 mm



BOWMAN (Williams)

- 45.1326.00 Fig-00 0.7 mm
- 45.1330.00 Fig-0 0.8 mm
- 45.1334.01 Fig-1 0.9 mm
- 45.1338.02 Fig-2 1.1 mm
- 45.1342.03 Fig-3 1.3 mm
- 45.1346.04 Fig-4 1.4 mm
- 45.1350.05 Fig-5 1.5 mm
- 45.1354.06 Fig-6 1.6 mm
- 45.1358.07 Fig-7 1.8 mm
- 45.1362.08 Fig-8 1.9 mm



BOWMAN

- 45.1366.00 Fig-00 0.7 mm
- 45.1370.00 Fig-0 0.8 mm
- 45.1374.01 Fig-1 0.9 mm
- 45.1378.02 Fig-2 1.1 mm
- 45.1382.03 Fig-3 1.3 mm
- 45.1386.04 Fig-4 1.4 mm
- 45.1390.05 Fig-5 1.5 mm
- 45.1394.06 Fig-6 1.6 mm
- 45.1398.07 Fig-7 1.8 mm
- 45.1402.08 Fig-8 1.9 mm



BOWMAN

45.1406.00
set of lacrimal channel probe
bestehend aus 5 verschiedenen sonden in behälter
juegode sondas para canal lacrimal



ROLF
45.1410.00



CASTROVIEJO
45.1414.00



ZIEGLER
45.1417.00

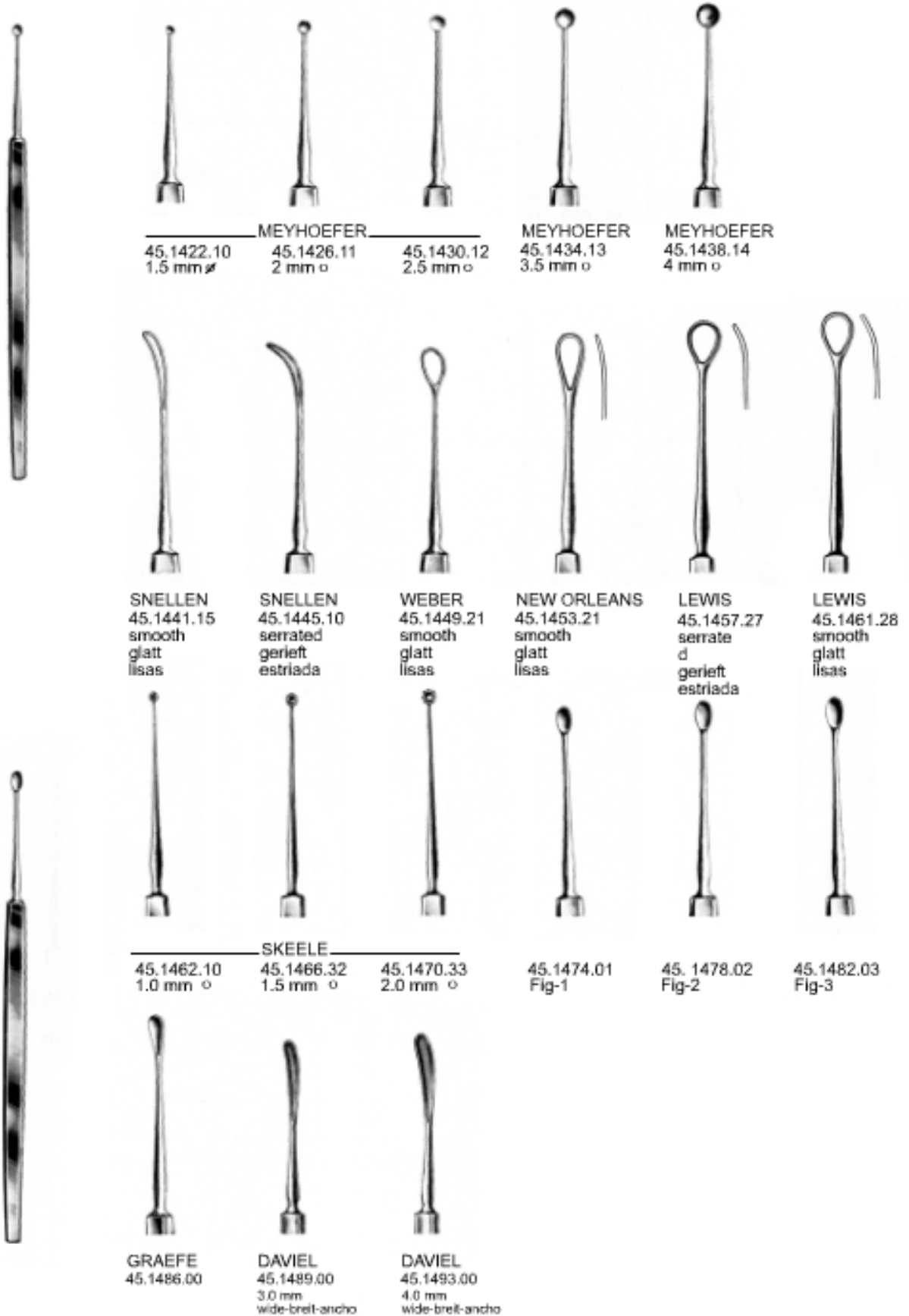

Eye Scalpels
Augenskalpelle
Bisturies Para Ojos



Fig - 1

45.1498.01
5 mm



Fig - 2

ZIEGLER
45.1502.02
6 mm



Fig - 3

45.1506.03
7 mm



45.1510.06
6 mm



KNAPP
45.1514.07
7 mm



45.1518.08
8 mm



WHEELER
45.1522.00



GALEZOWSKY
45.1526.00



GRAEFE
45.1529.00



BARKAN
45.1532.
00



GRAEFE
45.1534.00



GRAEFE
45.1538.00



45.1542.00
1,3 x 23 mm
Fig-0



45.1546.01
1,5 x 25 mm
Fig-1



45.1550.02
1,7 x 27 mm
Fig-2



45.1554.03
2,0 x 30 mm
Fig-3



45.1558.04
2,3 x 33 mm
Fig-4



GRAEFE
45.1562.05
2,5 x 35 mm
Fig-5



45.1565.06
3,0 x 32 mm
Fig-6



DEUTSCHMANN
45.1568.00



JAEGER

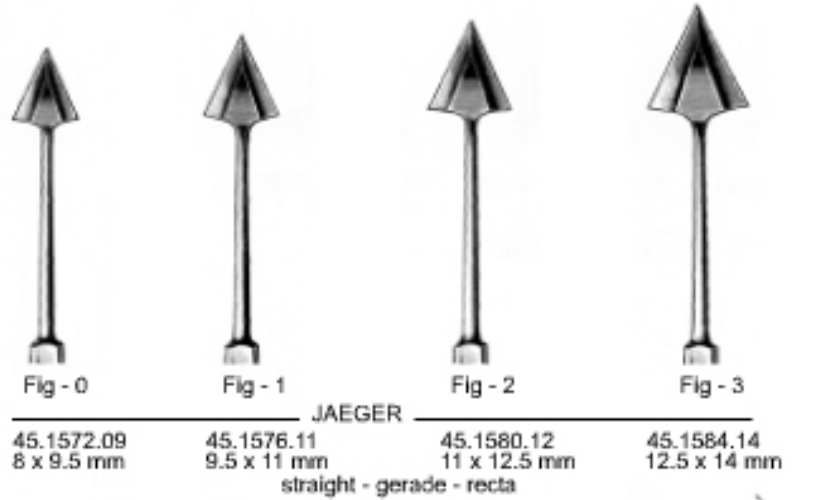

ROWLAND
45.1603.05
3.5 x 5 mm



CASTROVIEJO
45.1607.13
4 x 13 mm



EYE MAGNET
45.1650.00



Suture



Needle Holder
Nadelhalter
Porta - Agujas

46

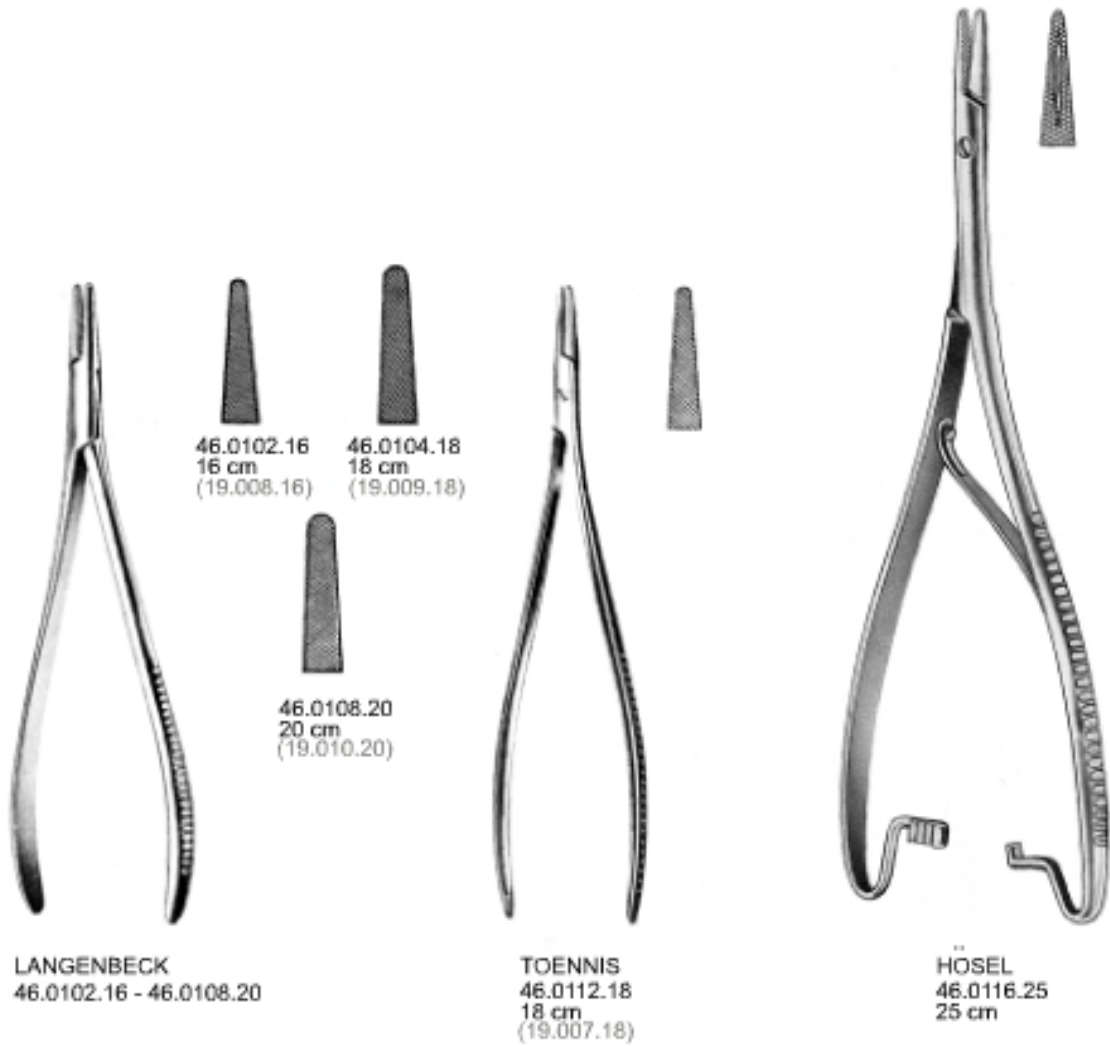

46

Needle Holder
Nadelhalter
Porta - Agujas



46.0128.20
20 cm



46.0132.23
23 cm

ZWEIFEL
46.0128.20 - 46.0132.23



CRILE
46.0136.15
15 cm



EISELSBERG-MATHIEU
46.0139.18
18.5 cm

Needle Holder
Nadelhalter
Porta - Agujas

46



MATHIEU
46.0144.14 - 46.0152.20



MATHIEU
46.0156.14 - 46.0160.17

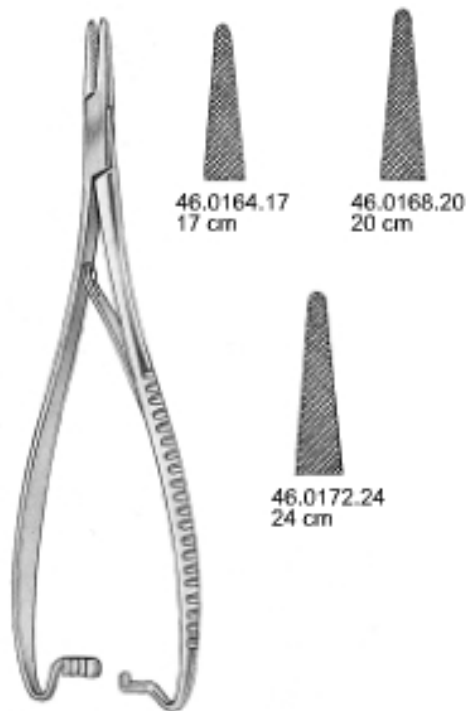

MATHIEU
46.0164.17 - 46.0172.24



GILLIES
46.0175.16
16 cm



WERTHEIM
46.0179.2020 cm
46.0183.2424 cm



WANGENSTEEN
46.0188.27
27 cm

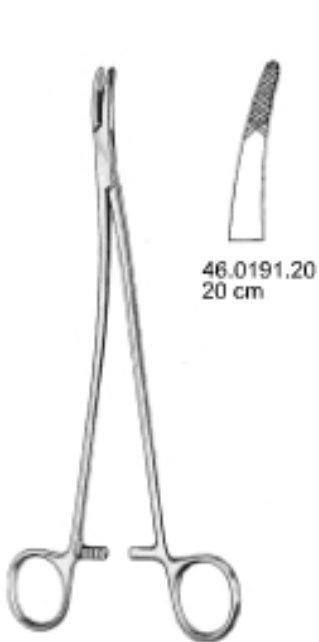

STRATTE
46.0191.20 - 46.0195.23



FINOCCHIETTO
46.0199.27
27 cm

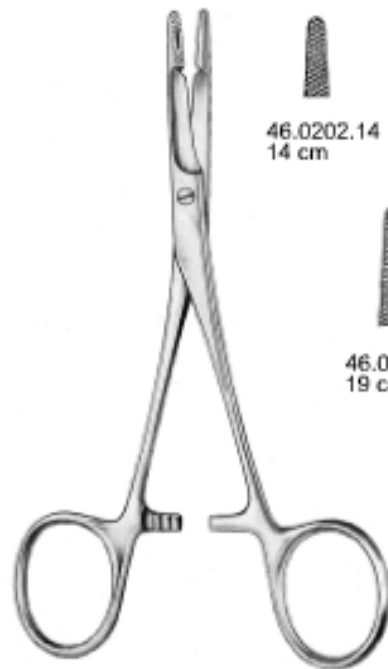

OLSEN-HEGAR
46.0202.14 - 46.0210.19



Needle Holder
Nadelhalter
Porta - Agujas

46



JAMESON
46.0214.23
23.5 cm



HEANEY
46.0217.21
21 cm



MASSON
46.0220.27
27 cm



MAYO-HEGAR
46.0224.16 - 46.0232.20

46.0224.16 46.0228.18 46.0232.20
16 cm 18 cm 20 cm
(19.004.16) (19.004.18) (19.004.20)



MAYO-HEGAR-GRAZIL
46.0236.16 - 46.0244.20

46.0236.16 46.0240.18 46.0244.20
16 cm 18 cm 20 cm
(19.005.16) (19.005.18) (19.005.20)
delicate - schlankes - delgado

46

Needle Holder
Nadelhalter
Porta - Agujas



DERF
46.0248.12
12 cm



COLLIER
46.0252.12
12.5 cm



DOYEN
46.0256.12
12.5 cm



DERF-CONVERSE
46.0260.12
12.5 cm



46.0264.16 46.0265.16

ARRUGA
46.0264.16 - 46.0265.16
16 cm



46.0268.12
12 cm
(19.013.12)



BOYNTON

46.0272.12
12 cm
(19.014.12)

Needle Holder
Nadelhalter
Porta - Agujas

46

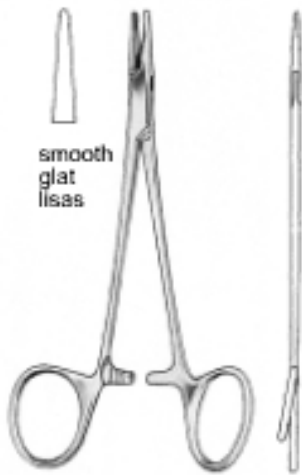

NEIVERT
46.0276.13
13 cm



KILNER
46.0280.13
13 cm



WEBSTER
46.0284.13
13 cm
(19.001.13)

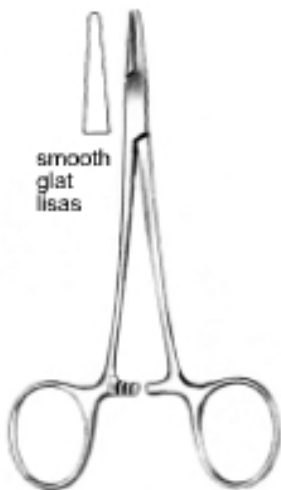

HALSEY
46.0288.13
13 cm
(19.002.13)



CRILE-WOOD
46.0292.15 - 46.0296.18



BABY-CRILE-WOOD
46.0300.15
15 cm

46

Needle Holder
Nadelhalter
Porta - Aguja



BOZEMANN
46.0304.20 - 46.0312.26



46.0304.20
20 cm



46.0308.24
24 cm



46.0312.26
26 cm



CARROLL
46.0316.15
15 cm

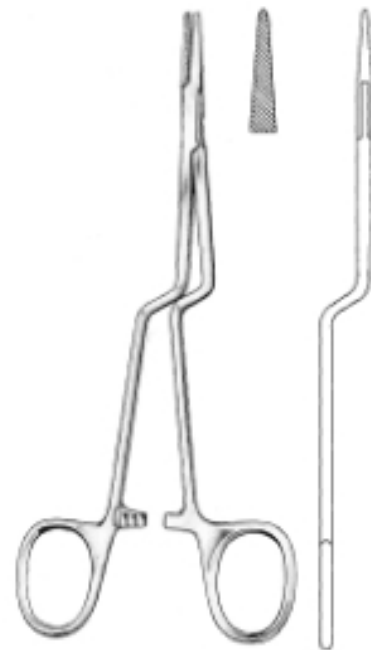

JACOBSON
46.0320.18
18 cm

Needle Holder
Nadelhalter
Porta - Aguja

46



NEW ORLEANS
46.0324.18
18 cm



46.0328.18
18 cm

46.0332.26
26 cm

SAROT
46.0328.18 - 46.0332.26

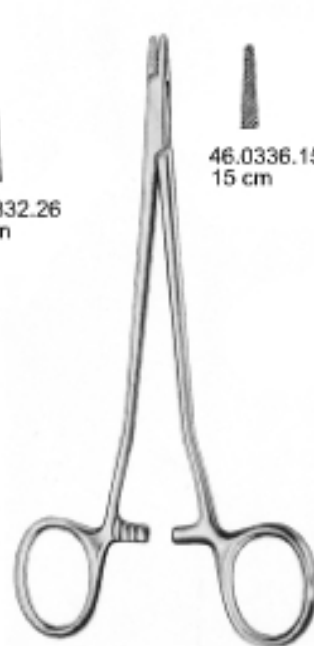

46.0336.15
15 cm

46.0340.17
17 cm

SENNING (Schwed-Model)
46.0336.15 - 46.0340.17



46.0344.13
13 cm

46.0348.18
18 cm

BROWN
46.0344.13 - 46.0348.18

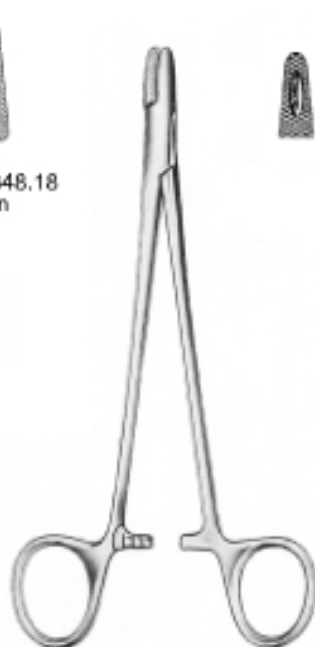

M.G.H.
46.0352.17
17 cm



ADSON
46.0356.18
18 cm

TC GOLD

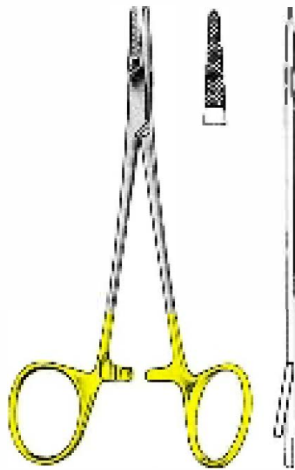

NEIVERT
 46.0360.13
 13 cm

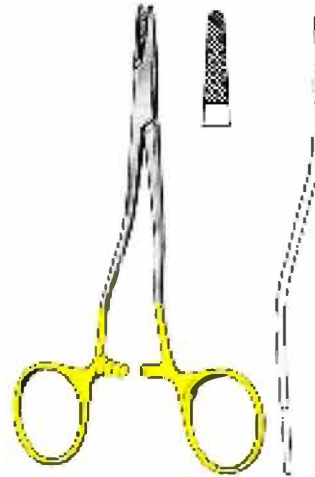

KILNER
 46.0364.13
 13.5 cm

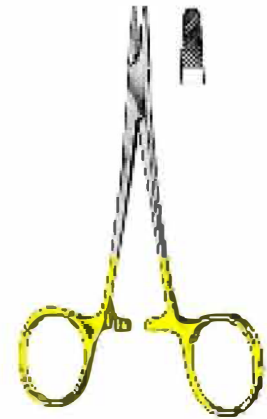

DERF
 46.0368.12
 12 cm
 (19.086.12)



HALSEY
 46.0372.13 - 46.0376.13
 13 cm

46.0372.13 46.0376.13
 (19.091.13) (19.092.13)
 smooth
 glatt
 lisas

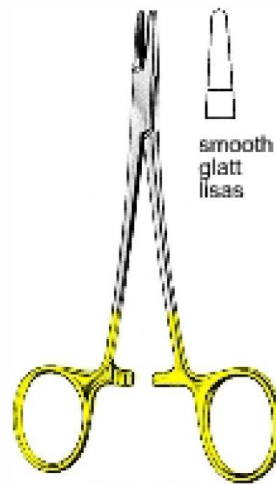

WEBSTER
 46.0380.13
 13 cm
 (19.095.12)

smooth
 glatt
 lisas

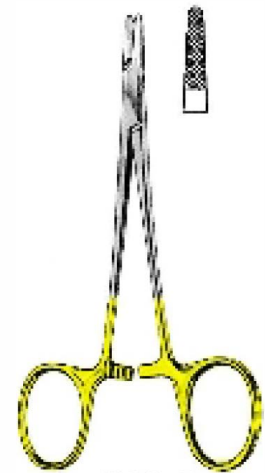

CONVERSE
 46.0384.12
 12.5 cm

Needle Holder with Tungsten Carbide Inserts
 Nadelhalter mit Hartmetalleinsätzen
 Porta - Aguja con bocas de carburo de tungsteno

TC GOLD

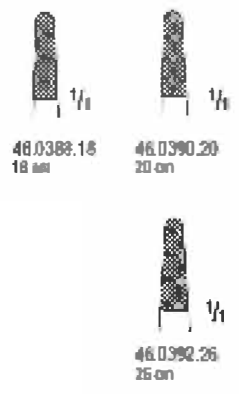
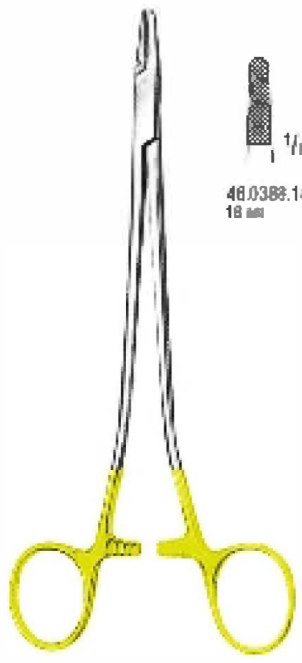

SAROT
46.0388.18 - 46.0392.26



METZENBAUM
46.0397.17 - 46.0399.19

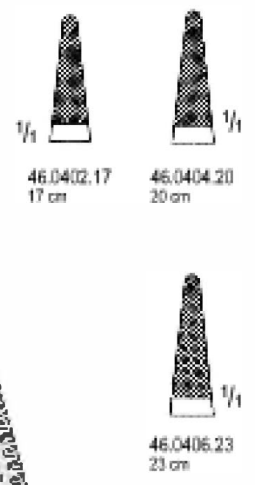

MATHIEU
46.0402.17 - 46.0406.23

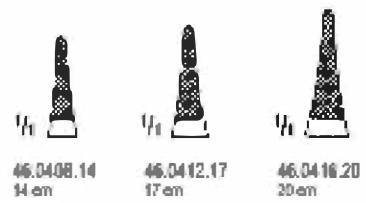

MATHIEU-DELICATE
46.0408.14 - 46.0416.20

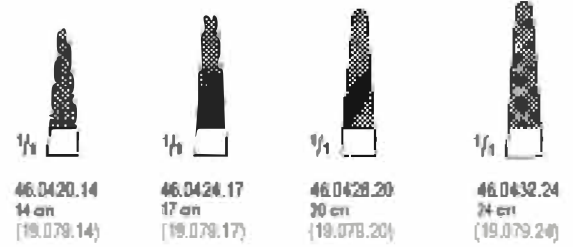

MATHIEU
46.0420.14 - 46.0432.24

46

Needle Holder with Tungsten Carbide Inserts
 Nadelhalter mit Hartmetalleinsätzen
 Porta - Aguja con bocas de carburo de tungsteno

TC GOLD

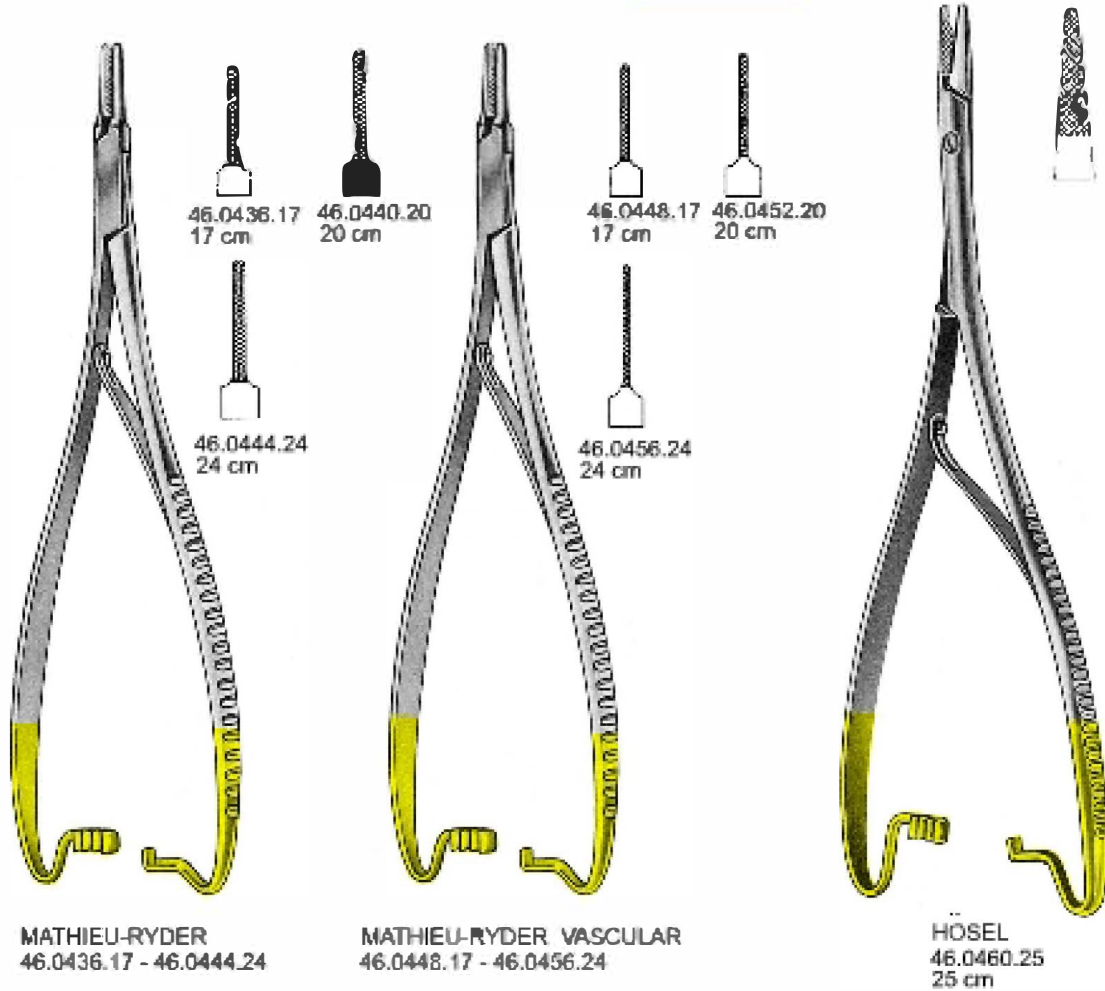

MATHIEU-RYDER
46.0436.17 - 46.0444.24

MATHIEU-RYDER VASCULAR
46.0448.17 - 46.0456.24

HOSEL
46.0460.25
25 cm

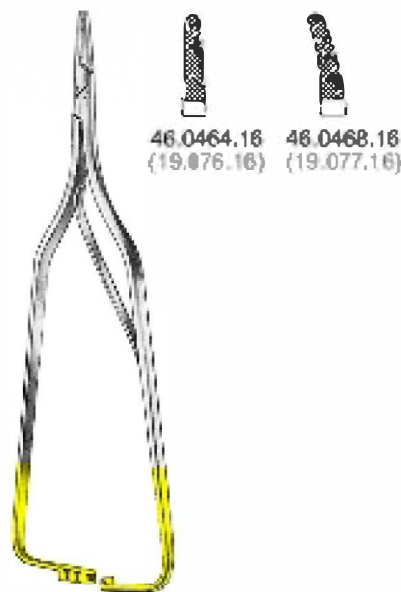

ARRUGA
46.0464.16 - 46.0468.16
16 cm

Needle Holder with Tungsten Carbide Inserts
Nadelhalter mit Hartmetalleinsätzen
Porta - Aguja con bocas de carburo de tungsteno

TC GOLD

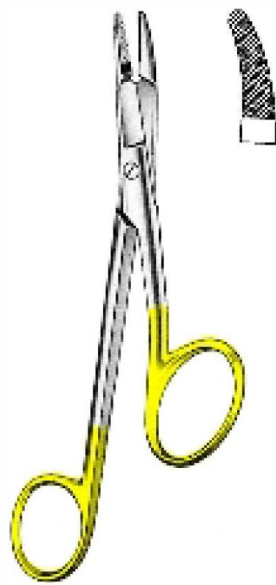

GILLIES
46.0471.16
16 cm
(19.088.16)



WERTHEIM
46.0474.20 - 46.0482.30

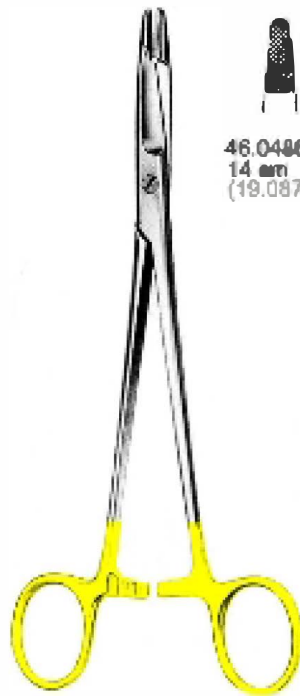
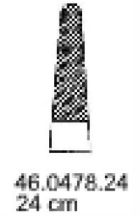

OLSEN-HEGAR
46.0486.14 - 46.0494.18



46

Needle Holder with Tungsten Carbide Inserts
 Nadelhalter mit Hartmetalleinsätzen
 Porta - Agujas con bocas de carburo de tungsteno

TC GOLD



RYDER VASCULAR
 46.0498.13 - 46.0542.26

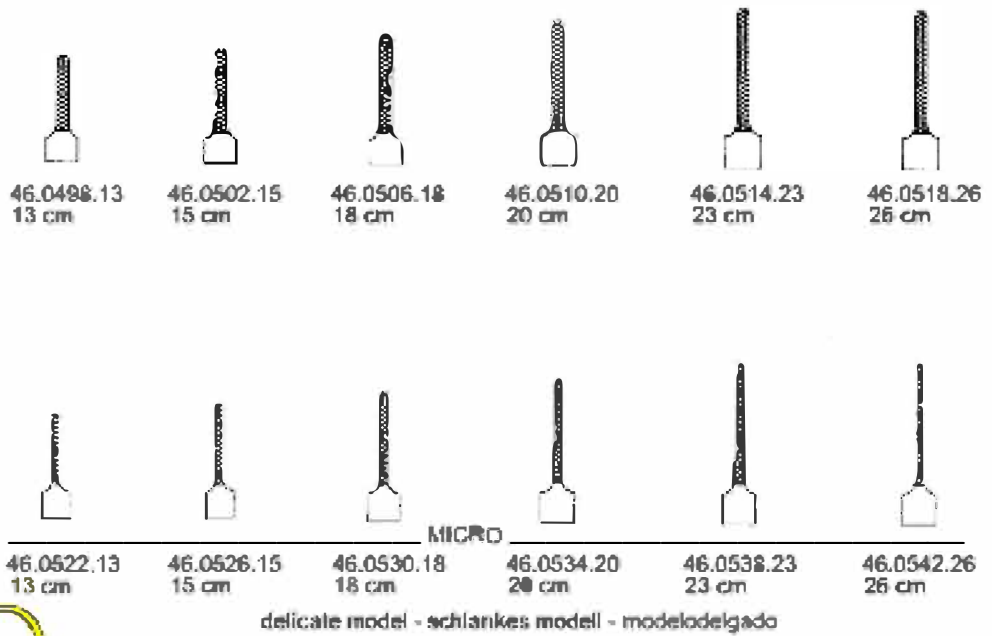

NEW ORLEANS
 46.0546.18
 18 cm

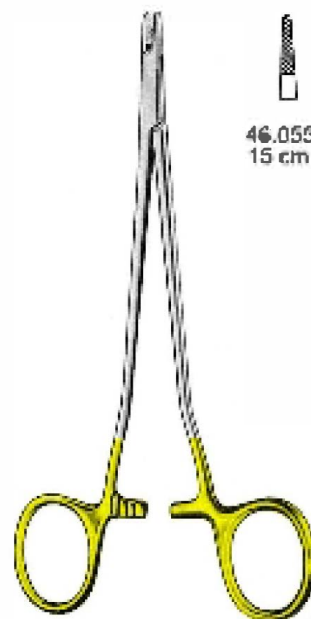

SENNING
 46.0550.15 - 46.0554.17

Needle Holder with Tungsten Carbide Inserts
 Nadelhalter mit Hartmetalleinsätzen
 Porta - Aguja con bocas de carburo de tungsteno

TC GOLD

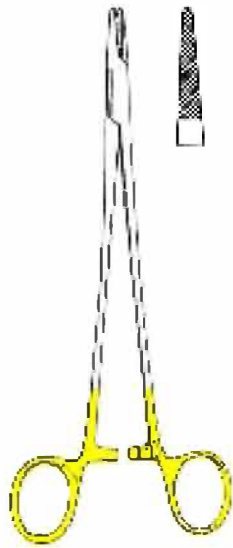



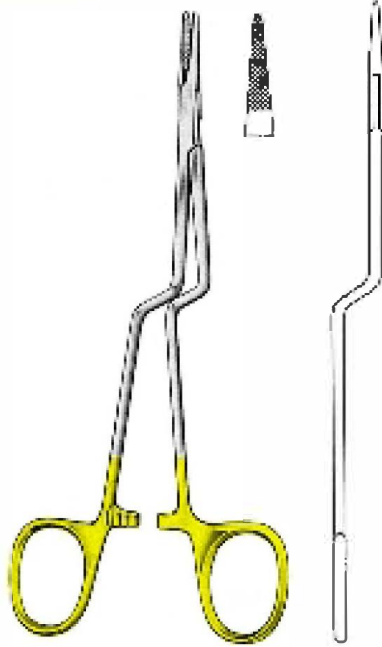

CARROLL
 46.0558.15
 15 cm







JACOBSON
 46.0562.18
 18 cm



HEGAR VASCULAR
 Microvascular
 46.0564.14 - 46.0578.23

- 
 46.0564.14
 14 cm
- 
 48.0506.18
 18 cm
- 
 46.0568.20
 20 cm
- 
 46.0570.23
 23 mm

- 
 46.0572.14
 14 cm
 - 
 46.0574.18
 18 cm
 - 
 46.0576.20
 20 cm
 - 
 46.0578.23
 23 cm
- smooth - glatt - lisas

46

Needle Holder with Tungsten Carbide Inserts
 Nadelhalter mit Hartmetalleinsätzen
 Porta - Ajujas con bocas de carburo de tungsteno

TC GOLD

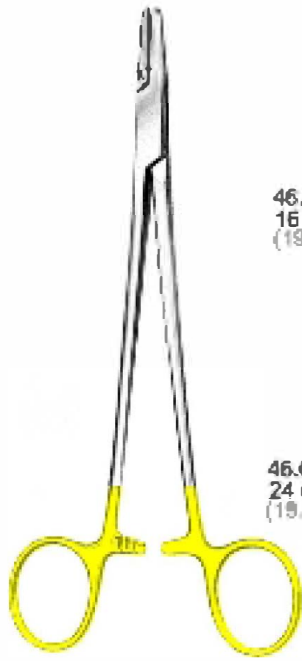

MAYO-HEGAR
 46.0580.16 - 46.0600.30

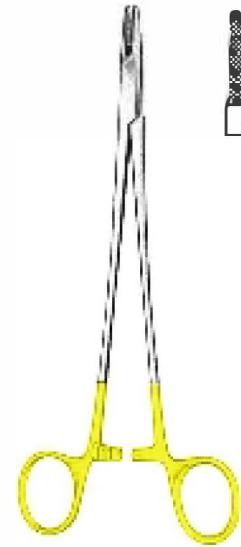
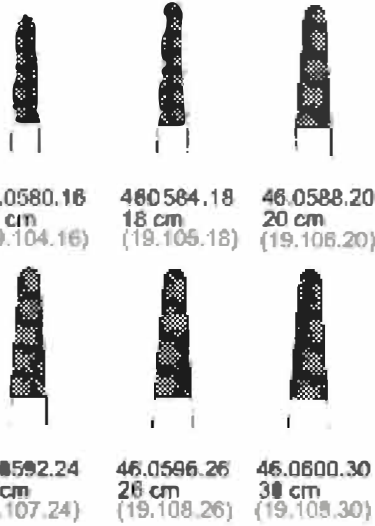

CRILE-WOOD
 46.0602.15

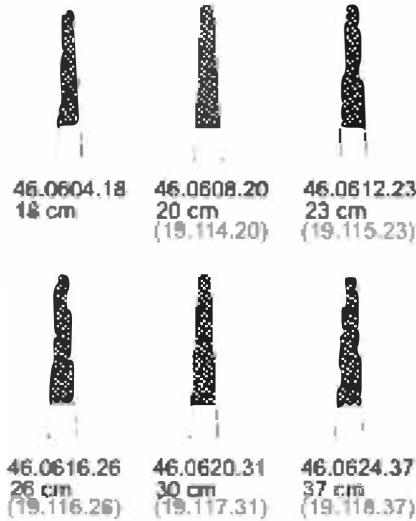
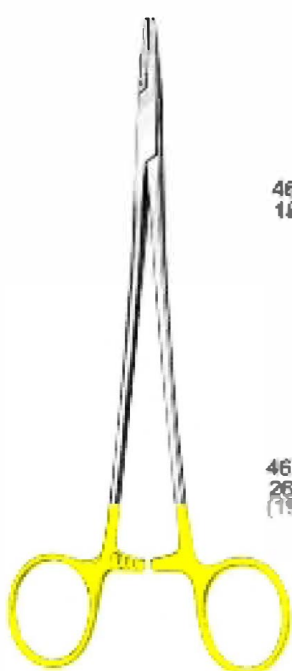

Needle Holder with Tungsten Carbide Inserts
 Nadelhalter mit Hartmetalleinsätzen
 Porta - Aguja con bocas de carburo de tungsteno

TC GOLD





POTT-SMITH
 46.0628.22
 22 cm
 (19.128.22)





KALT
 46.0632.13
 13.5 cm



- 

46.0636.16
 16 cm
 (19.118.16)
- 

46.0640.18
 18 cm
 (19.119.18)
- 

46.0644.20
 20 cm
 (19.120.20)
- 

46.0648.23
 23 cm
 (19.121.23)
- 

46.0652.26
 26 cm
 (19.122.26)

DIETRICH
 46.0636.16 - 46.0652.26

46

Needle Holder with Tungsten Carbide Inserts
 Nadelhalter mit Hartmetalleinsätzen
 Porta - Aguja con bocas de carburo de tungsteno

TC GOLD



46.0656.21 46.0660.21

smooth
glatt
lisas

JACOBSON
 46.0656.21 - 46.0660.21
 21 mm



46.0664.14 46.0669.14

CASTROVIEJO
 46.0664.14 - 46.0669.14
 14 cm



46.0672.14 46.0675.14
 smooth
glatt
lisas smooth
glatt
lisas

CASTROVIEJO
 46.0672.14 - 46.0675.14
 14 cm



46.0682.12 46.0685.12



CASTROVIEJO

Needle Holder with Tungsten Carbide Inserts
 Nadelhalter mit Hartmetallinsätzen
 Porta - Agujas can bascas de carburo de tungsteno

TC GOLD



LICHTENBERG
 46.0692.17
 17 cm

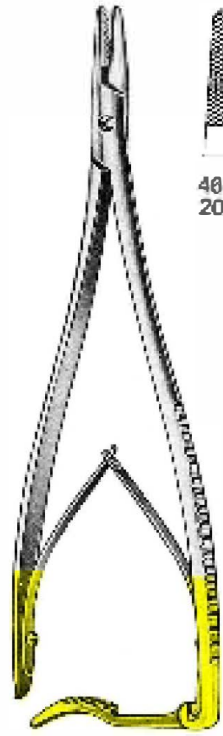

ZWEIFEL
 46.0896.20 - 46.0700.23



46.0896.20
 20 cm



46.0700.23
 23 cm

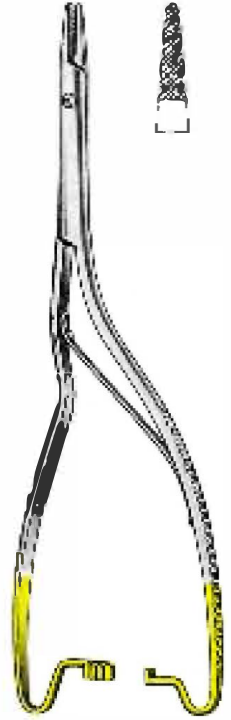

LUETHY-BECK
 46.0704.20
 20 cm

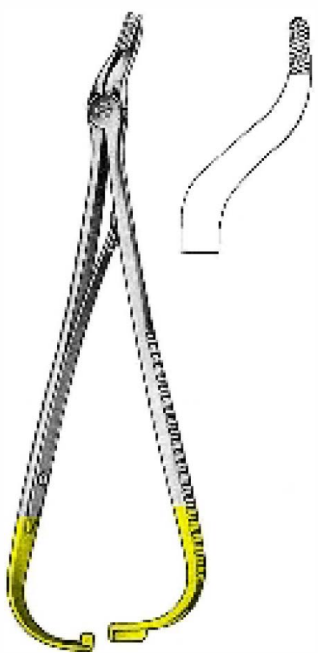

EISELSBERG-MATHIEU
 46.0707.18
 18.5 cm



LANGENBECK, LEICHT
 46.0710.16 - 46.0726.25



46.0710.16
 16 cm
 (19.081.16)



46.0714.18
 18 cm
 (19.082.18)



46.0718.20
 20 cm
 (19.083.20)



46.0722.22
 22 cm
 (19.084.22)



46.0726.25
 25 cm
 (19.085.25)

46

Wire Twisting Forceps with Tungsten Carbide Inserts
 Drahtzangen mit Hartmetalleinsätzen
 Pinzas Para Torcer Hilos con bocas de carburo de tungsteno

TC GOLD

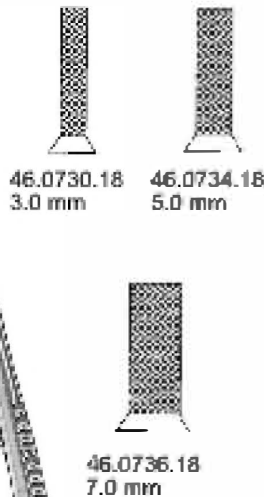

46.0730.18 - 46.0736.18
18 cm

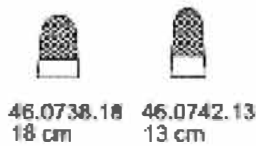
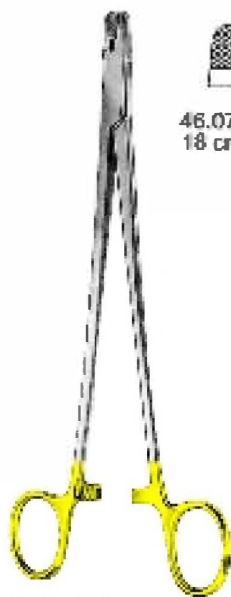

STERNUM
46.0738.18 - 46.0742.13

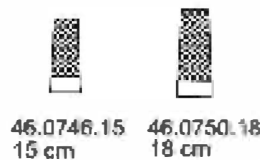

46.0746.15 - 46.0754.18



46.0758.18
18.5 cm

Micro Needle Holder
 Mikro Nadelhalter
 Micro Porta - Agujas

46



46.0762.23
 23 cm
 (19.019.23)



46.0765.23
 23 cm
 (19.020.23)



46.0769.19
 19 cm
 (19.021.19)

MICRO
 46.0762.23 - 46.0770.19



MICRO
 46.0777.16
 16 cm
 (19.018.16)



KALT-ARRUGA
 46.0781.14
 14 cm



CASTROVIEJO-KALT
 46.0784.13
 13.5 cm

46

Micro Needle Holder
Mikro Nadelhalter
Micro Porta - Aguja



ARRUGA
46.0786.14 - 46.0791.14
14 cm



KALT
46.0796.14
14 cm



46.0800.13 13 cm
46.0804.15 15 cm

STEVENS
46.0800.13 - 46.0804.15

Micro Needle Holder
Mikro Nadelhalter
Micro Porta - Agujas

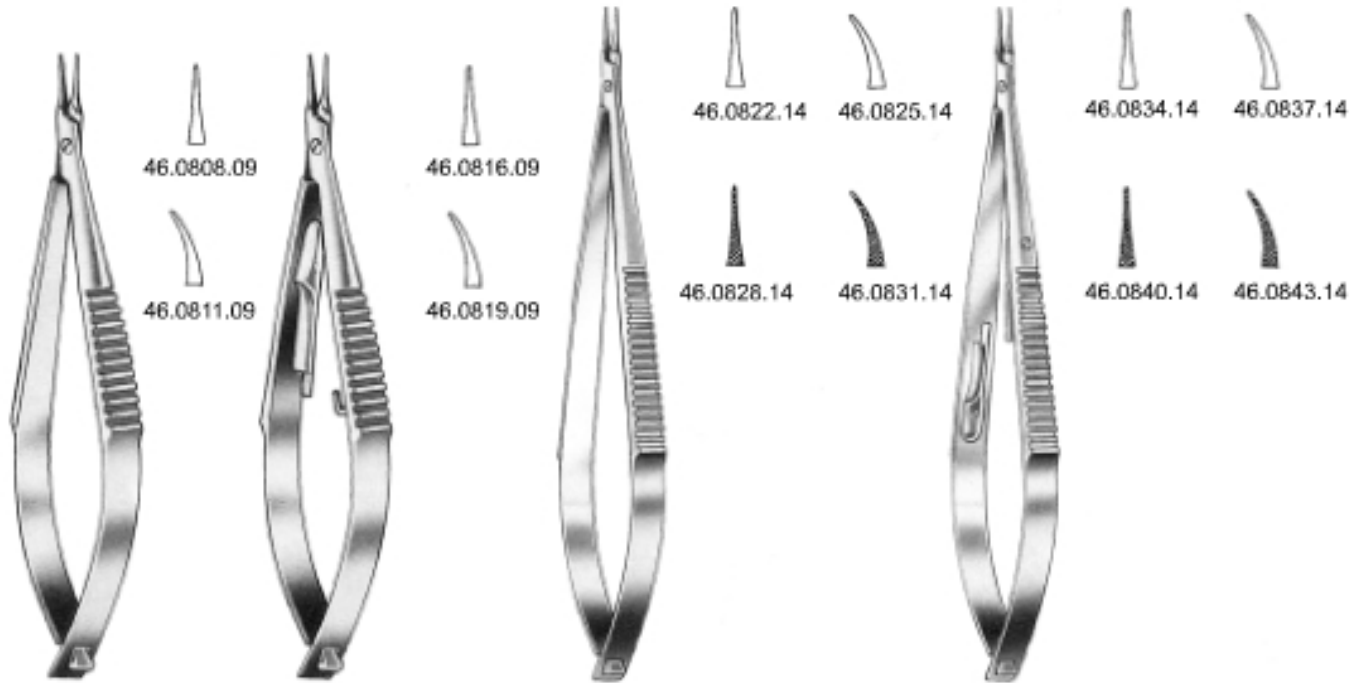

CASTROVIEJO
46.0808.09 - 46.0812.09
9 cm

CASTROVIEJO
46.0816.09 - 46.0819.09
9 cm

CASTROVIEJO
46.0822.14 - 46.0831.14
14 cm

CASTROVIEJO
46.0834.14 - 46.0843.14
14 cm

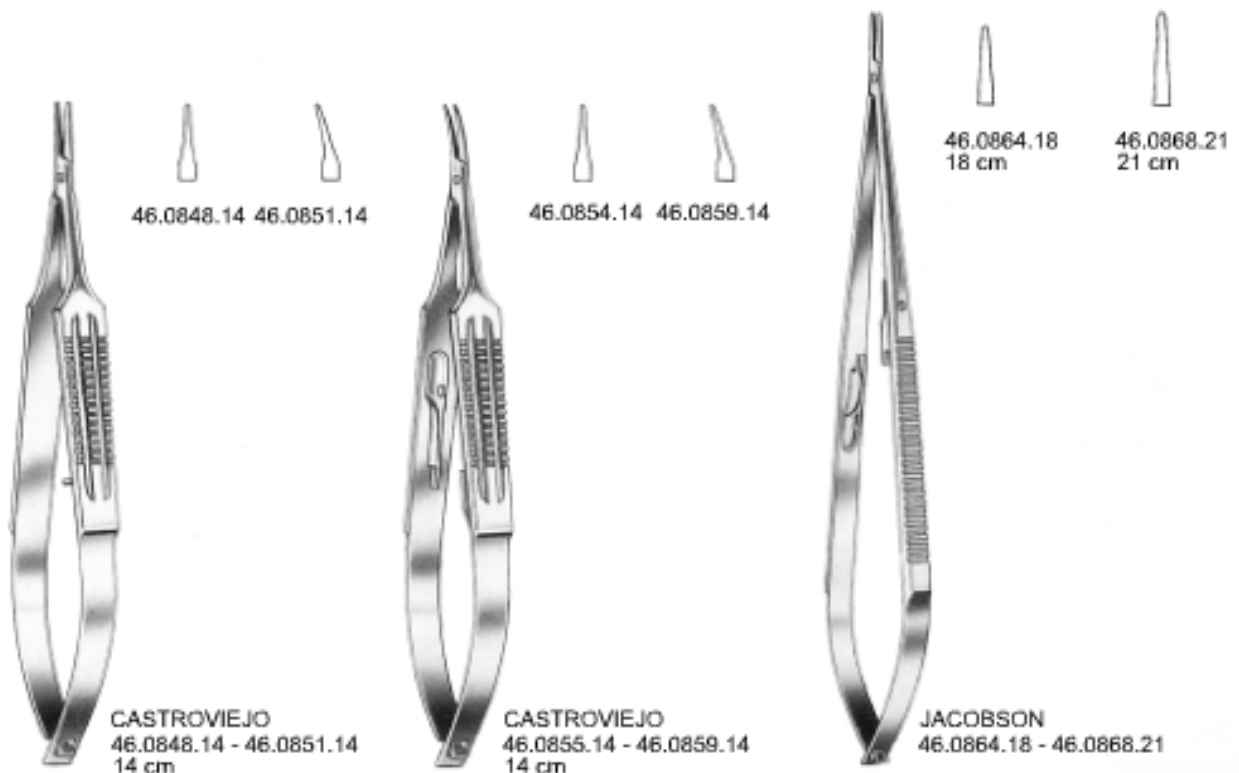

CASTROVIEJO
46.0848.14 - 46.0851.14
14 cm

CASTROVIEJO
46.0855.14 - 46.0859.14
14 cm

JACOBSON
46.0864.18 - 46.0868.21
18 cm

46

Micro Needle Holder
Mikro Nadelhalter
Micro Porta - Aguja



BARRAQUER
46.0871.11
11 cm



BARRAQUER
46.0875.13
13 cm



BARRAQUER
46.0879.14
14 cm



BARRAQUER
46.0884.14
14 cm



BARRAQUER
46.0887.14
14 cm



46.0891.00
14 cm

Micro Needle Holder
 Mikro Nadelhalter
 Micro Porta - Aguja



TROUTMAN
 46.0895.12
 12 cm



TROUTMAN
 46.0899.12
 12 cm



PATON
 46.0902.11
 11 cm



PATON
 46.0907.11
 11 cm



BARRAQUER-
 TROUTMAN
 46.0910.10
 10 cm



BARRAQUER-
 TROUTMAN
 46.0913.10
 10 cm



BARRAQUER-
 TROUTMAN
 46.0918.10
 10 cm



BARRAQUER-
 TROUTMAN
 46.0921.10
 10 cm

46

Micro Needle Holder
Mikro Nadelhalter
Micro Porta - Aguja



46.0925.14
14 cm



46.0929.14
14 cm



REILL
46.0932.15 - 46.0935.15
15 cm

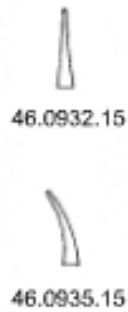

46.0932.15

46.0935.15



REILL
46.0938.15 - 46.0941.15
15 cm

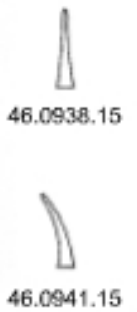

46.0938.15

46.0941.15

Micro Needle Holder
Mikro Nadelhalter
Micro Porta - Agujas

46



46.0944.18
18 cm



46.0947.18
18 cm



46.0952.18
18 cm



46.0953.18
18 cm



46.0956.13



46.0959.13

CASTROVIEJO
46.0956.13 - 46.0959.13
13 cm
handle 8 mm \varnothing
griff 8 mm \varnothing
mango 8 mm \varnothing



46.0962.13



46.0965.13

CASTROVIEJO
46.0962.13 - 46.0965.13
13 cm
handle 8 mm \varnothing
griff 8 mm \varnothing
mango 8 mm \varnothing



46.0968.13



46.0971.13

CASTROVIEJO
46.0968.13 - 46.0971.13
13 cm
handle 10 mm \varnothing
griff 10 mm \varnothing
mango 10 mm \varnothing



46.0974.13



46.0977.13

CASTROVIEJO
46.0974.13 - 46.0977.13
13 cm
handle 10 mm \varnothing
griff 10 mm \varnothing
mango 10 mm \varnothing



MICHEL
46.0982.12
12 cm



WACHENFELDT
46.0986.12
12.5 cm



MICHEL
46.0989.12
12 cm



RICHTER-HEATH
46.0993.14
14 cm

46

Ligature Needles
Unterbindungsnadeln
Agujas Para Ligadura



46.0996.20 46.1000.20

DESCHAMPS blunt stumpf Romo
46.0996.20 - 46.1000.20
20 cm



46.1004.20 46.1008.20

DESCHAMPS sharp scharf agudo
46.1004.20 - 46.1008.20
20 cm

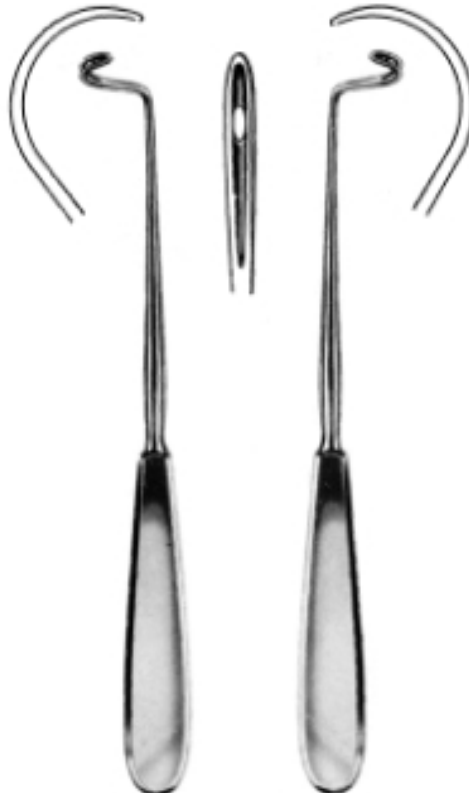

46.1012.21 46.1016.21
DESCHAMPS blunt stumpf romo
46.1012.21 - 46.1016.21

Reverdin Needles
Reverdin Nadeln
Agujas de Reverdin

46



REVERDIN
46.1021.23
22.5 cm



REVERDIN
46.1025.19 - 46.1053.23



46.1025.19 19.5 cm
46.1029.23 23.5 cm



46.1033.19 19.5 cm
46.1037.23 23.5 cm



46.1041.19 19.5 cm
46.1045.23 23.5 cm



46.1049.19 19.5 cm
46.1053.23 23.5 cm



Cotton Swab Forcep



Cotton Swab Forceps, Polypus and Dressing Forceps
 Tupferzangen, Kam - { polypen-} Zangen
 Pinzas para toponnes, Pinzas para polipos y vendajes

47



PELKMANN
 47.0102.25
 25 cm



PELKMANN
 47.0103.25
 25 cm



CHERON
 47.0105.25
 25 cm

47

Cotton Swab Forceps, Polypus and Dressing Forceps
 Tupferzangen, Korn - (polypen-) Zangen
 Pinzas para taponnes, Pinzas para polipos y vendajas



FLETCHER
 47.0108.24
 24 cm



FLETCHER
 47.0109.24
 24 cm

Cotton Swab Forceps, Polypus and Dressing Forceps
 Tupferzangen, Korn - (polypen-) Zangen
 Pinzas para taponnes, Pinzas para polipos y vendajas



FOERSTER-BALLENGER
 47.0112.18 - 47.0125.20

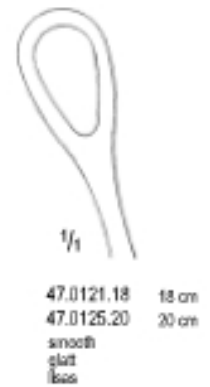
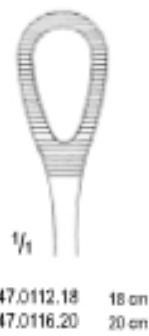

FOERSTER-BALLENGER
 47.0128.25 - 47.0133.25
 25 cm



47

Cotton Swab Forceps, Polypus and Dressing Forceps
Tupferzangen, Korn - (polypen-) Zangen
Pinzas para taponnes, Pinzas para polipos y vendajas



FOERSTER
47.0136.25 - 47.0137.25
25 cm



47.0136.25

47.0137.25



47.0141.17 17 cm
47.0145.25 25 cm

WALTON
47.0140.17 17 cm
47.0144.25 25 cm

Cotton Swab Forceps, Polypus and Dressing Forceps
 Tupferzangen, Korn - (polypen-) Zangen
 Pinzas para taponnes, Pinzas para polipos y vendajas



HEYWOOD-SMITH
 47.0148.21
 21 cm



DUPLAY
 47.0152.20
 20.5 cm



DUPLAY
 47.0153.20
 20.5 cm



HEYWOOD-SMITH
 47.0156.25
 25 cm

47

Cotton Swab Forceps, Polypus and Dressing Forceps
Tupferzangen, Korn - (polypen-) Zangen
Pinzas para taponnes, Pinzas para polipos y vendajas



LISTER
47.0160.16
16 cm

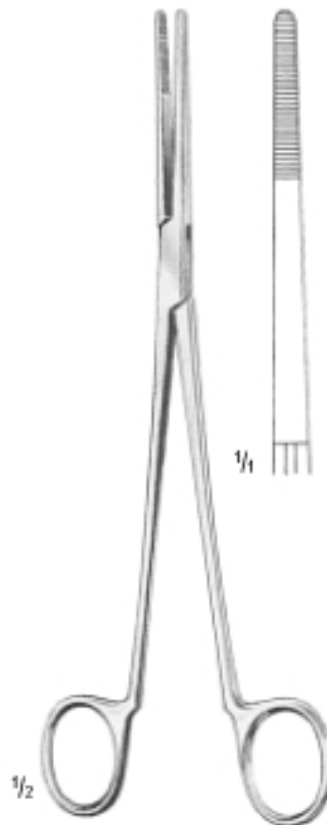

WESTERMARK
47.0164.23
23 cm

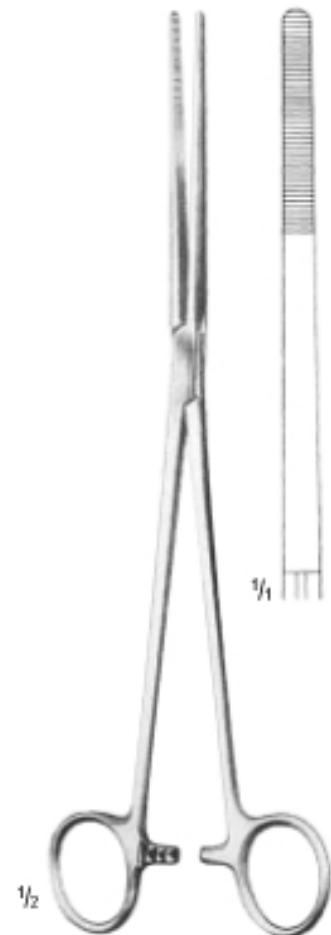

BOZEMANN
47.0168.26
26 cm

Cotton Swab Forceps, Polypus and Dressing Forceps
Tupferzangen, Korn - (polypen-) Zangen
Pinzas para taponnes, Pinzas para polipos y vendojas

47

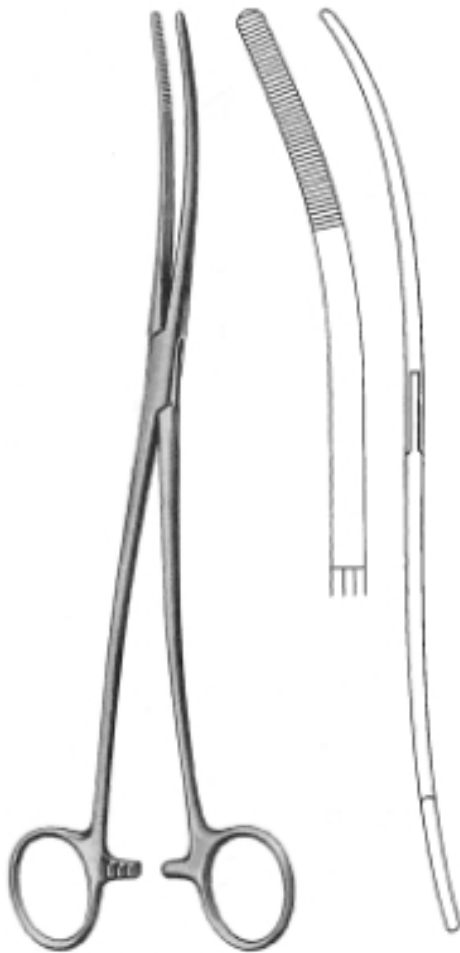

BOZEMANN
47.0173.26
26 cm

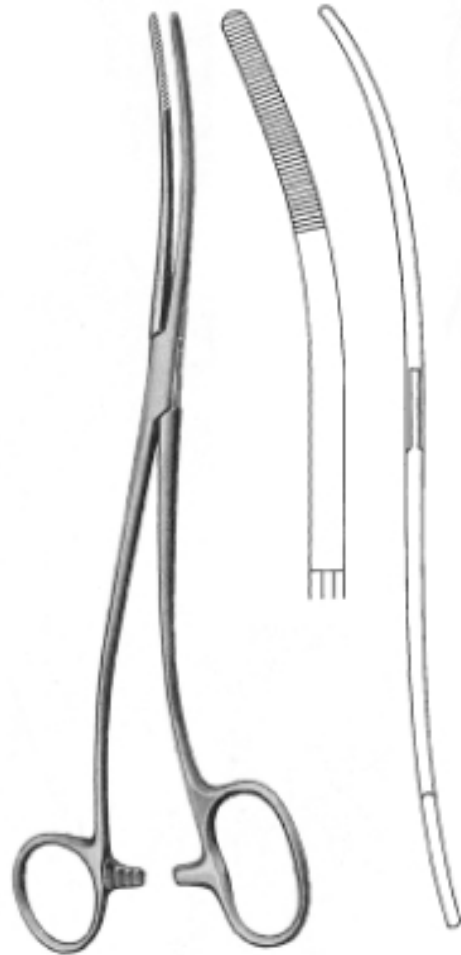

BOZEMANN-DOUGLAS
47.0177.26
26 cm

47

Cotton Swab Forceps, Polypus and Dressing Forceps
Tupferzangen, Korn - (polypen-) Zangen
Pinzas para taponnes, Pinzas para polipos y vendajas

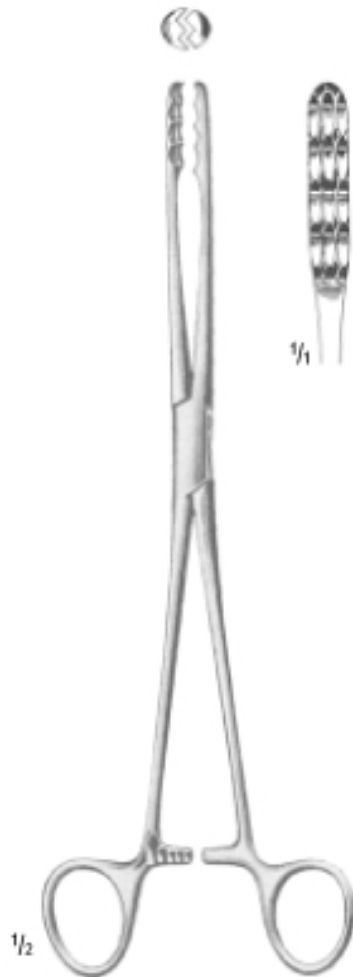

ULRICH
47.0180.22 22 cm
47.0184.25 26 cm

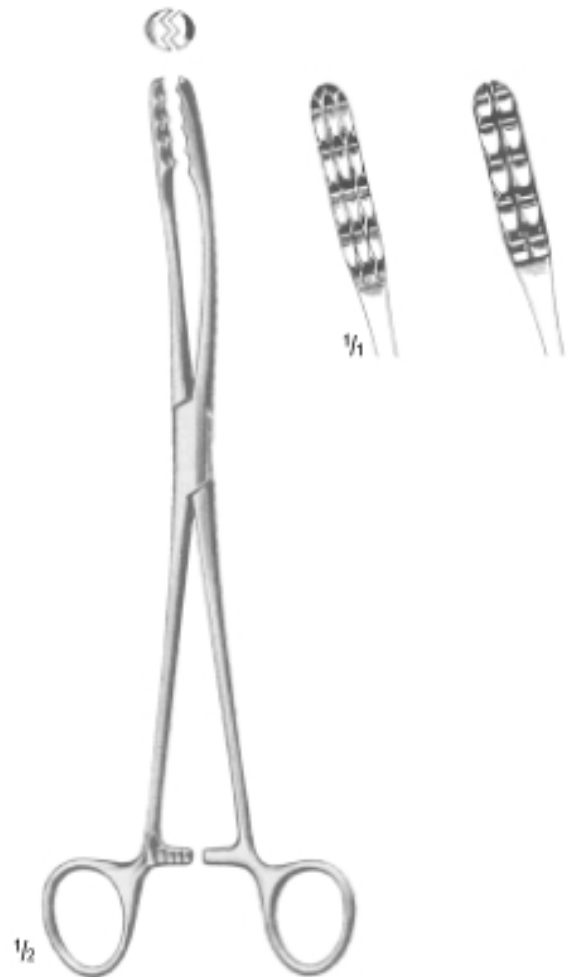

ULRICH
47.0181.22 22 cm
47.0185.25 26 cm

Cotton Swab Forceps, Polypus and Dressing Forceps
Tupferzangen, Korn - (polypen-) Zangen
Pinzas para taponnes, Pinzas para polipos y vendojas

47



GROSS
47.0188.20
20 cm
(18.047.20)



GROSS
47.0189.20
20 cm
(18.048.20)

47

Cotton Swab Forceps, Polypus and Dressing Forceps
Tupferzangen, Korn - (polypen-) Zangen
Pinzas para taponnes, Pinzas para polipos y vendajas



MAIER
47.0192.26
26 cm
(18.049.26)



MAIER
47.0193.26
26 cm
(18.050.26)

Cotton Swab Forceps, Polypus and Dressing Forceps
 Tupferzangen, Korn - (polypen-) Zangen
 Pinzas para taponnes, Pinzas para polipos y vendojas

47

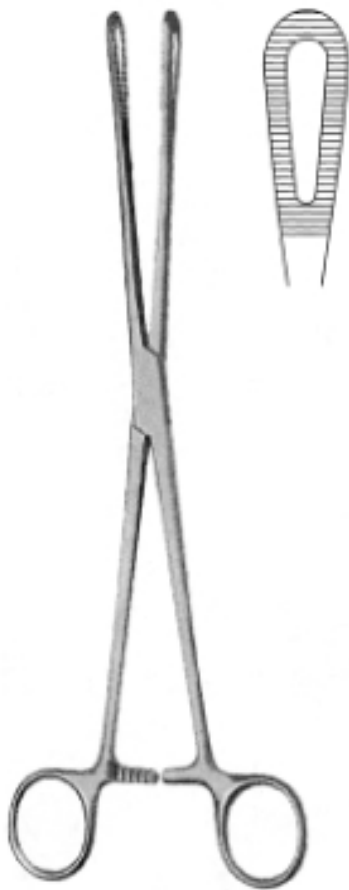

RAMPLEY
 47.0196.25
 25 cm



SIMS-MAIER
 47.0200.28
 28 cm



SIMS-MAIER
 47.0201.28
 28 cm



Retractors

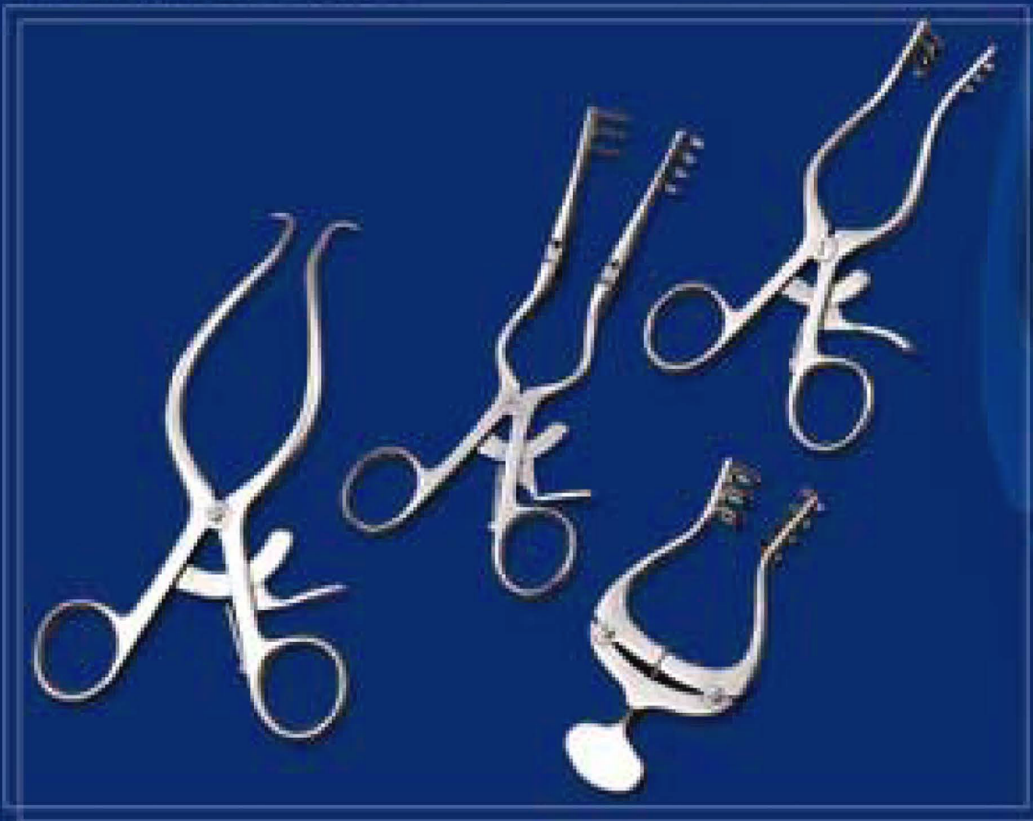

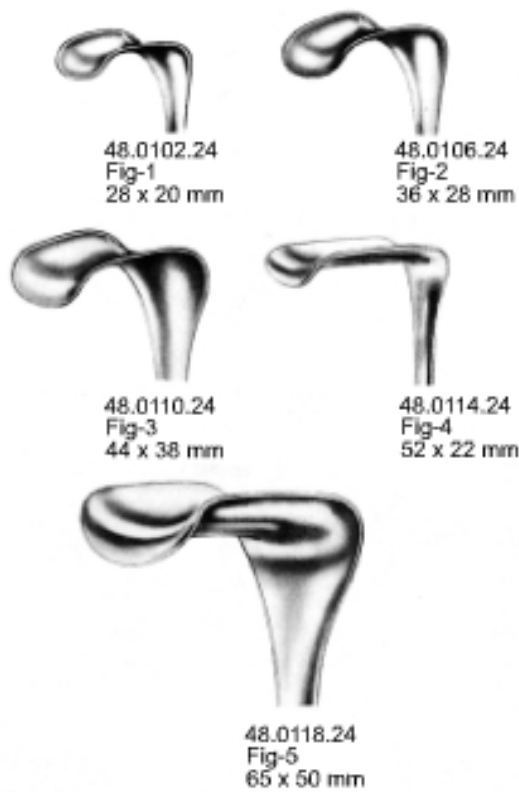

RICHARDSON
(KELLY)
48.0102.24 - 48.0118.24
24 cm

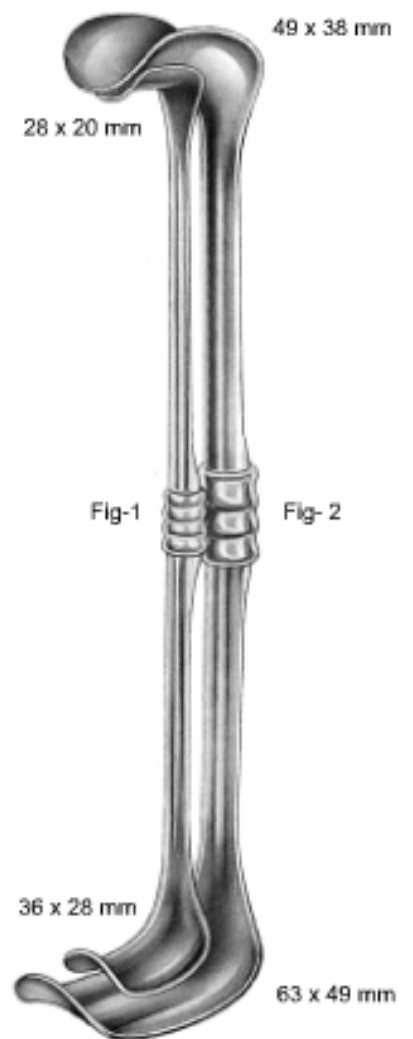

RICHARDSON-EASTMAN
48.0126.26 26 cm fig # 1
48.1130.28 28 cm fig # 2



MIDDELDORPF
48.0134.21
48.0142.22
48.0150.23



48.0134.21 21.5 cm
48.0138.21 21.5 cm
14 x 17 mm



48.0142.22 22 cm
48.0146.22 22 cm
20 x 22 mm



48.0150.23 23.5 cm
48.0154.23 23.5 cm
26 x 30 mm



MIDDELDORPF
48.0138.21
48.0146.22
48.0154.23
(17-040-00)



LAHEY
48.0156.19
19 cm



LITTLE
48.0162.20
20 cm

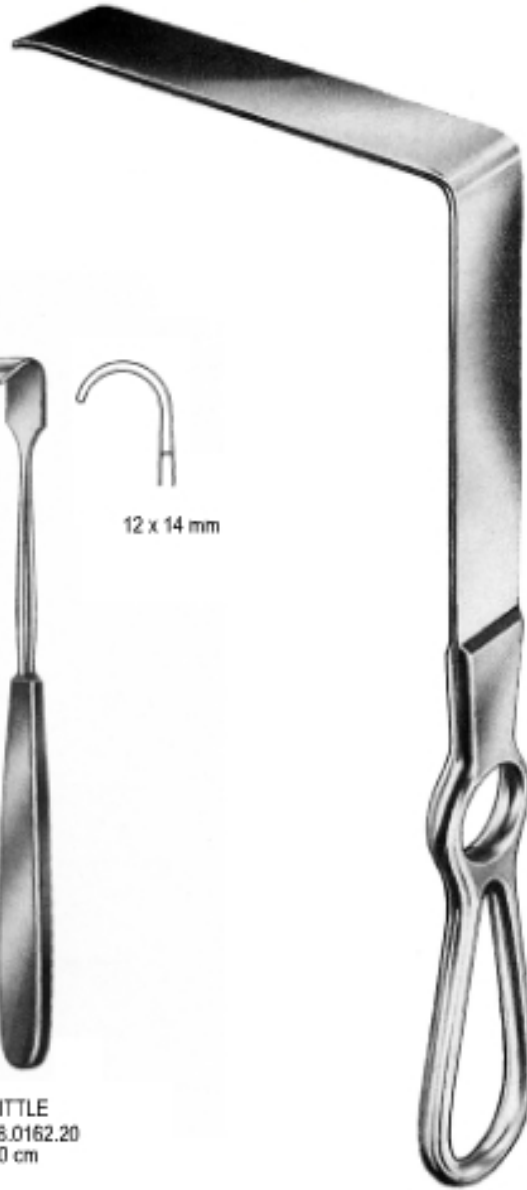

BRUNNER
48.0166.25 - 48.0186.25
25 cm

BRUNNER

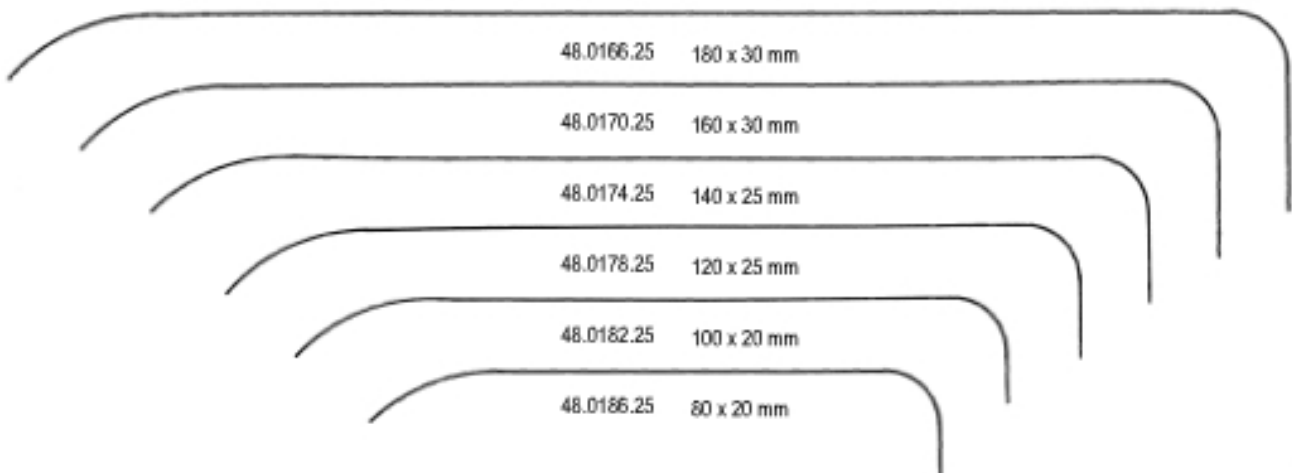

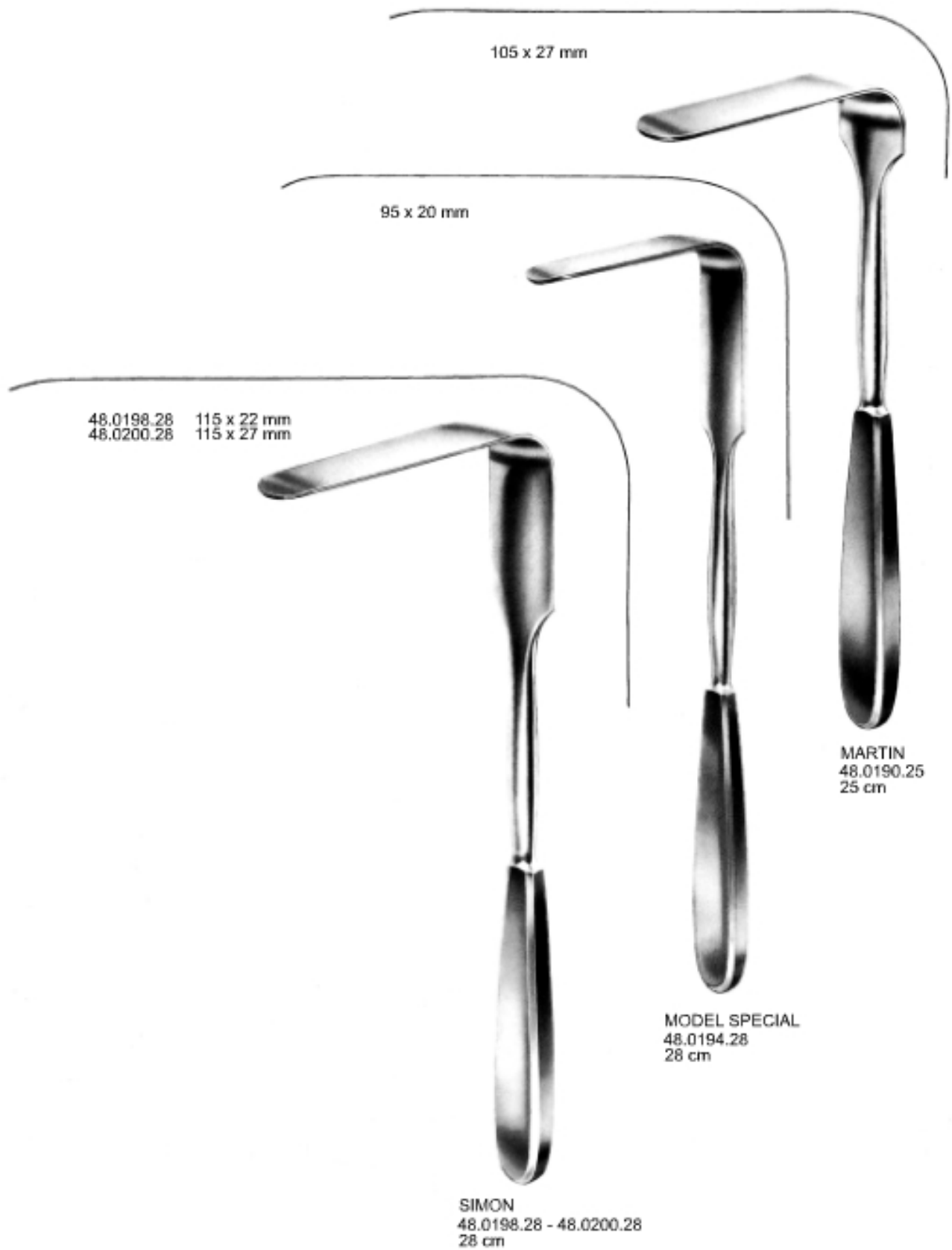



KOCHER
 48.0202.23 - 48.0216.23
 23 cm

48.0202.23
 40 x 18 mm

48.0204.23
 60 x 20 mm

48.0208.23
 60 x 25 mm

48.0212.23
 75 x 30 mm

48.0216.23
 75 x 40 mm

48.0220.22
 44 x 16 mm

48.0224.22
 55 x 22 mm

48.0228.22
 72 x 19 mm



KOCHER
 48.0220.22 - 48.0228.22
 22.5 cm



48.0232.21
25 x 6.0 mm



48.0236.21
35 x 8.0 mm



48.0240.21
35 x 11 mm



48.0244.21
35 x 15 mm



48.0248.21
40 x 11 mm



48.0252.21
55 x 11 mm



48.0256.21
70 x 14 mm



48.0260.21
80 x 12 mm



48.0264.21
80 x 16 mm



KOCHER-LANGENBECK
48.0232.21 - 48.0264.21
21.5 cm
(17.037.21)

Retractors
Wundhaken
Separadores



48.0268.15
sharp
scharf
agudo



48.0269.15
blunt
stumpf
romo

BABY SENN-MILLER
48.0268.15 - 48.0269.15
15 cm



48.0272.16
sharp
scharf
agudo
(17.029.00)



48.0273.16
blunt
stumpf
romo

SENN-MILLER
48.0272.16 - 48.0273.16
16 cm



CUSHING
48.0276.20
20 cm



RAGNELL-DAVIS
48.0280.14
14 cm



48.0284.07
48.0285.07
48.0288.10 (17.007.10)
48.0289.10 (17.008.10)



ALM

7.0 cm sharp-scharf-agudo
7.0 cm blunt-stumpf-romo
10 cm sharp-scharf-agudo
10 cm blunt-stumpf-romo



FINZEN

48.0292.05 5.0 cm sharp-scharf-agudo
48.0293.05 5.0 cm blunt-stumpf-romo
48.0296.07 7.0 cm sharp-scharf-agudo (17.005.00)
48.0297.07 7.0 cm blunt-stumpf-romo (17.006.00)



VOLKMANN
48.0300.21 - 48.0337.21
21 cm
(17.035.21)

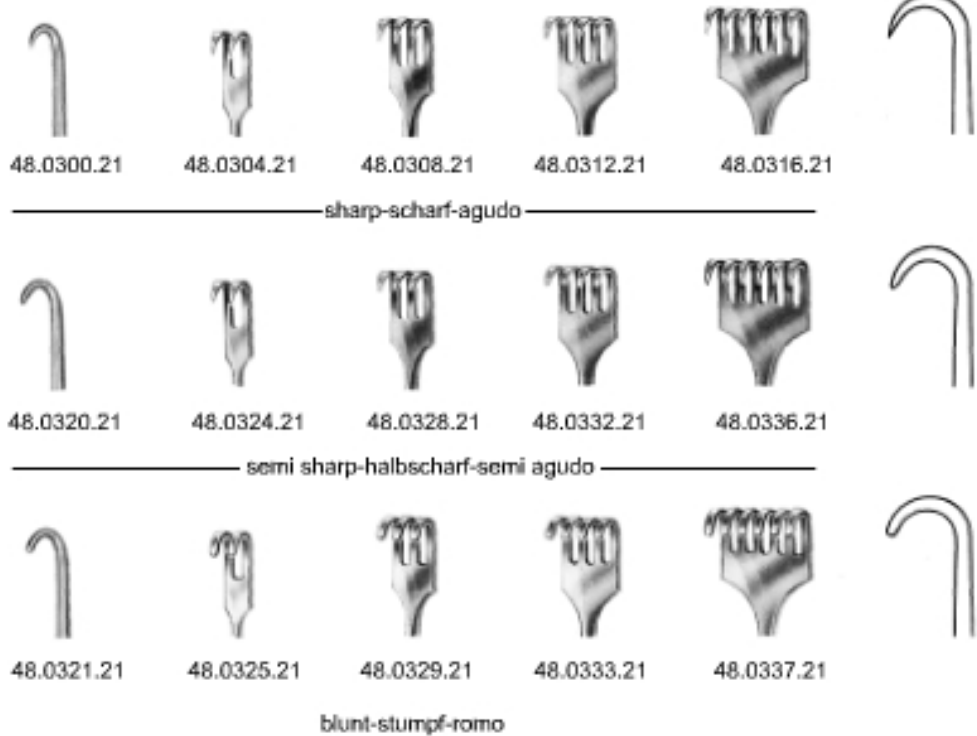

48.0300.21

48.0304.21

48.0308.21

48.0312.21

48.0316.21

sharp-scharf-agudo

48.0320.21

48.0324.21

48.0328.21

48.0332.21

48.0336.21

semi sharp-halbscharf-semi agudo

48.0321.21

48.0325.21

48.0329.21

48.0333.21

48.0337.21

blunt-stumpf-romo



VOLKMANN
48.0340.21 - 48.0341.21
21.5 cm



48.0340.21
sharp
scharf
agudo



48.0341.21
blunt
stumpf
romo



VOLKMANN
48.0344.20 - 48.0345.20
20 cm



48.0344.20
sharp
scharf
agudo



48.0345.20
blunt
stumpf
romo

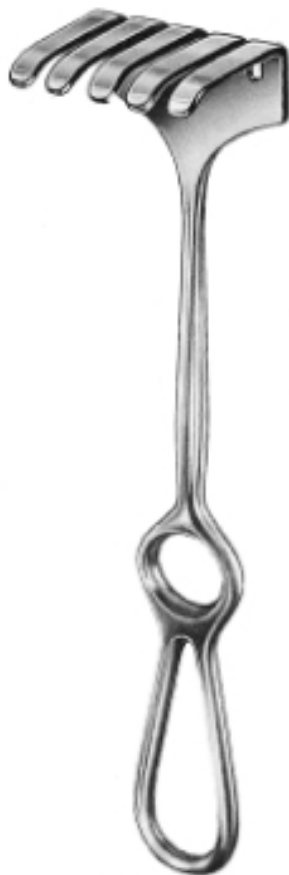

ISRAEL
48.0348.25 - 48.0360.25
25 cm



48.0348.25
40 x 40 mm



48.0352.25
45 x 50 mm



48.0356.25
50 x 60 mm



48.0360.25
70 x 70 mm





48.0377.22
36 x 60 mm



48.0381.22
36 x 30 mm



OLLIER
48.0377.22 - 48.0381.22
22.5 cm



48.0384.22



48.0388.22



48.0392.22



48.0396.22



48.0400.22



48.0404.22



sharp-scharf-agudo



48.0385.22



48.0389.22



48.0393.22



48.0397.22



48.0401.22



48.0405.22



semi sharp-halbscharf-semiagudo



48.0409.22



48.0413.22



48.0417.22



48.0421.22



48.0425.22



48.0429.22



blunt-stumpf-romo

KOCHER
48.0384.22 - 48.0429.22
22 cm

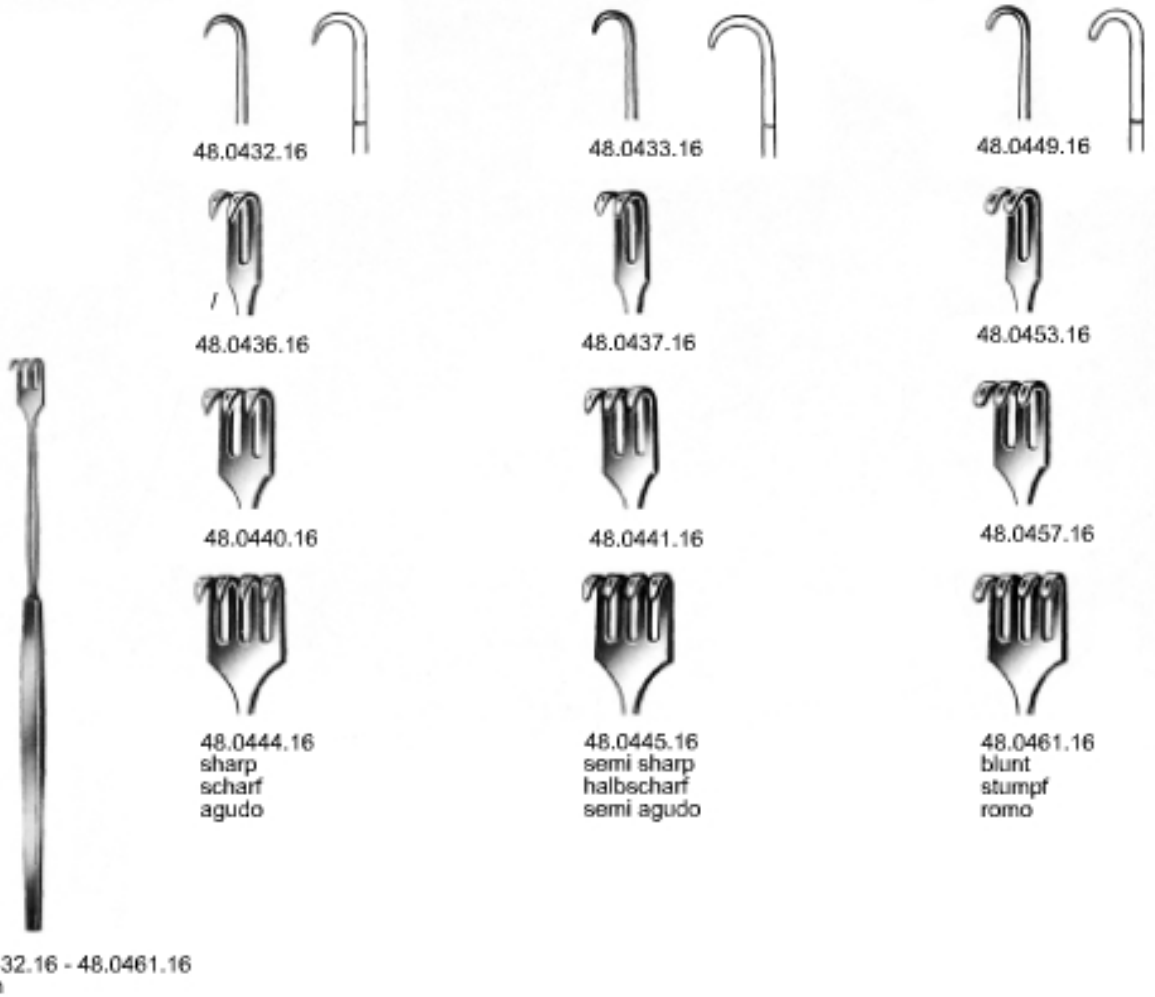

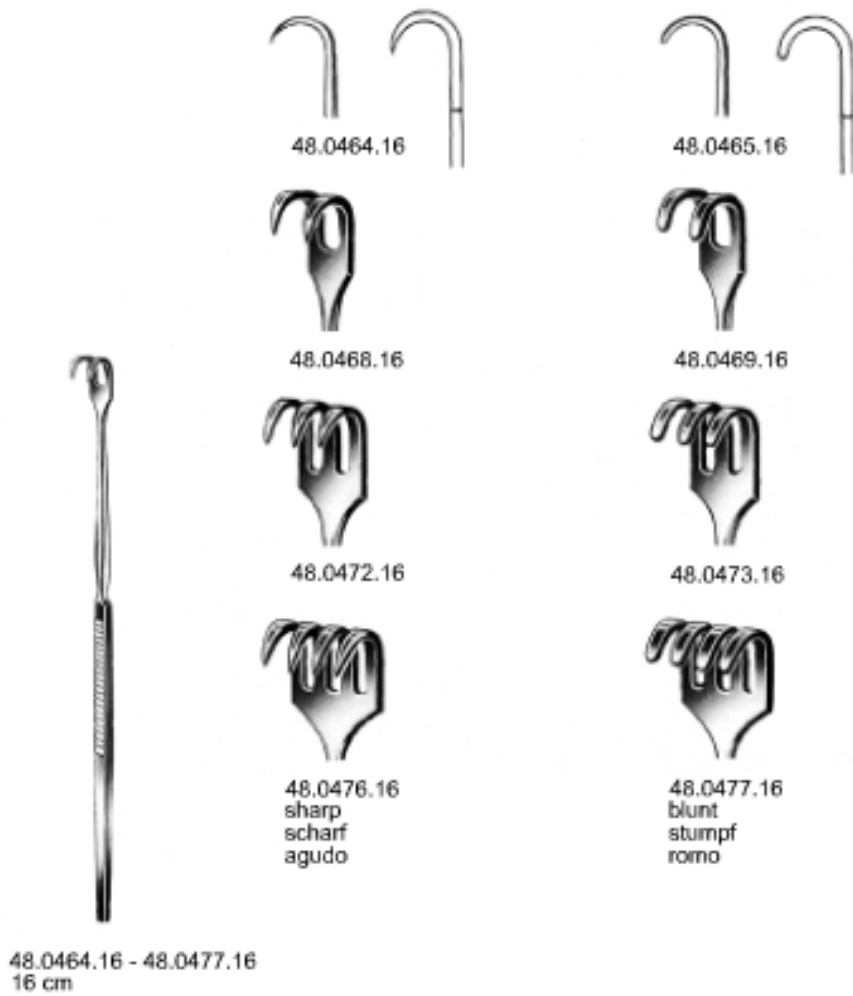



LANGENBECK
48.0480.21 - 48.0498.21
21 cm
(17.034.21)

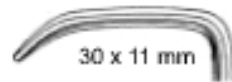

30 x 11 mm

48.0480.21
48.0481.22

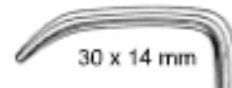

30 x 14 mm

48.0484.21
48.0485.22

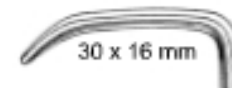

30 x 16 mm

48.0488.21
48.0489.22



40 x 11 mm

48.0494.21
48.0495.22



50 x 11 mm

48.0498.21
48.0499.22



LANGENBECK
48.0481.22 - 48.0499.22
22 cm



LANGENBECK
48.0502.21 - 48.0510.20
21 cm

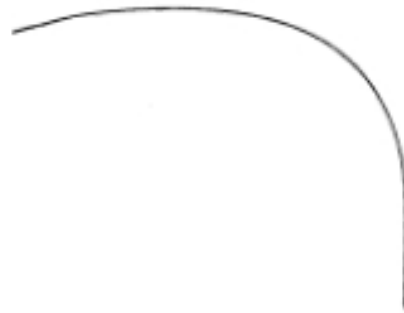

48.0502.21
55 x 20 mm



48.0506.21
60 x 20 mm

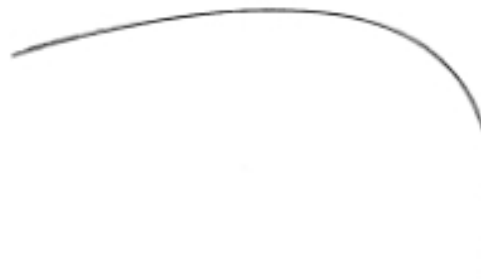

48.0510.21
63 x 20 mm

48

Delicate Hooks
Feine Wundhaken
Crochets Tres Fins



O'CONNOR
48.0514.16
16 cm

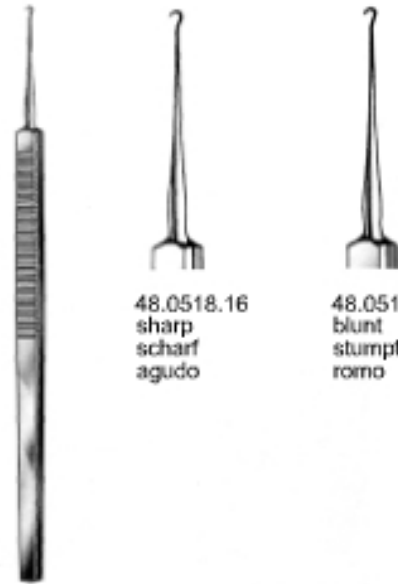

48.0518.16
sharp
scharf
agudo

48.0519.16
blunt
stumpf
romo

GRAEFE
48.0518.16 - 48.0519.16
16 cm



48.0522.16 - 48.0534.16
16 cm



48.0522.01
Fig-1



48.0526.02
Fig-2



48.0530.03
Fig-3



48.0534.04
Fig-4



MOLDESTAD
 48.0538.13
 13 cm



CUSHING
 48.0542.01 - 48.0546.02
 19 cm



48.0542.01
 Fig-1



48.0546.02
 Fig-2



CUSHING
 48.0550.01 - 48.0554.02
 28 cm



48.0550.01
 Fig-1



48.0554.02
 Fig-2



48.0558.01
Fig-1

48.0562.02
Fig-2

48.0574.01
Fig-1

48.0578.02
Fig-2

48.0582.03
Fig-3

GILLIES
48.0558.01 - 48.0562.02
18 cm

KILNER
48.0566.15
15 cm

FRAZIER
48.0570.13
13 cm

KLEINERT-KUTZ
48.0574.01 - 48.0582.03
16 cm

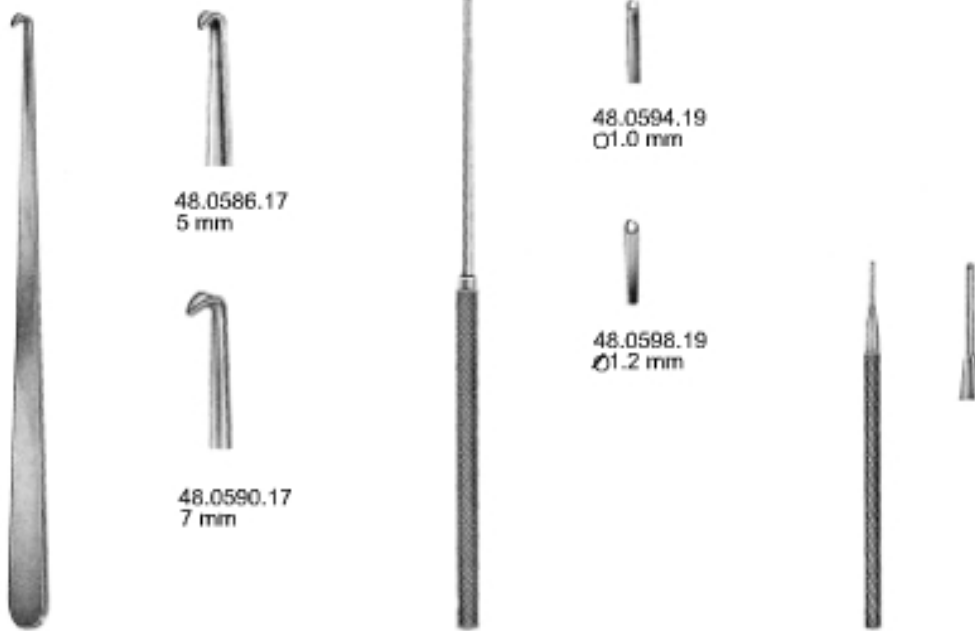

48.0586.17
5 mm

48.0594.19
Ø1.0 mm

48.0598.19
Ø1.2 mm

48.0590.17
7 mm

48.0586.17 - 48.0590.17
17 cm

48.0594.18 - 48.0598.18
18.5 cm

48.0602.11
11 cm

Delicate Hooks
Feine Wundhaken
Crochets Tres Fins

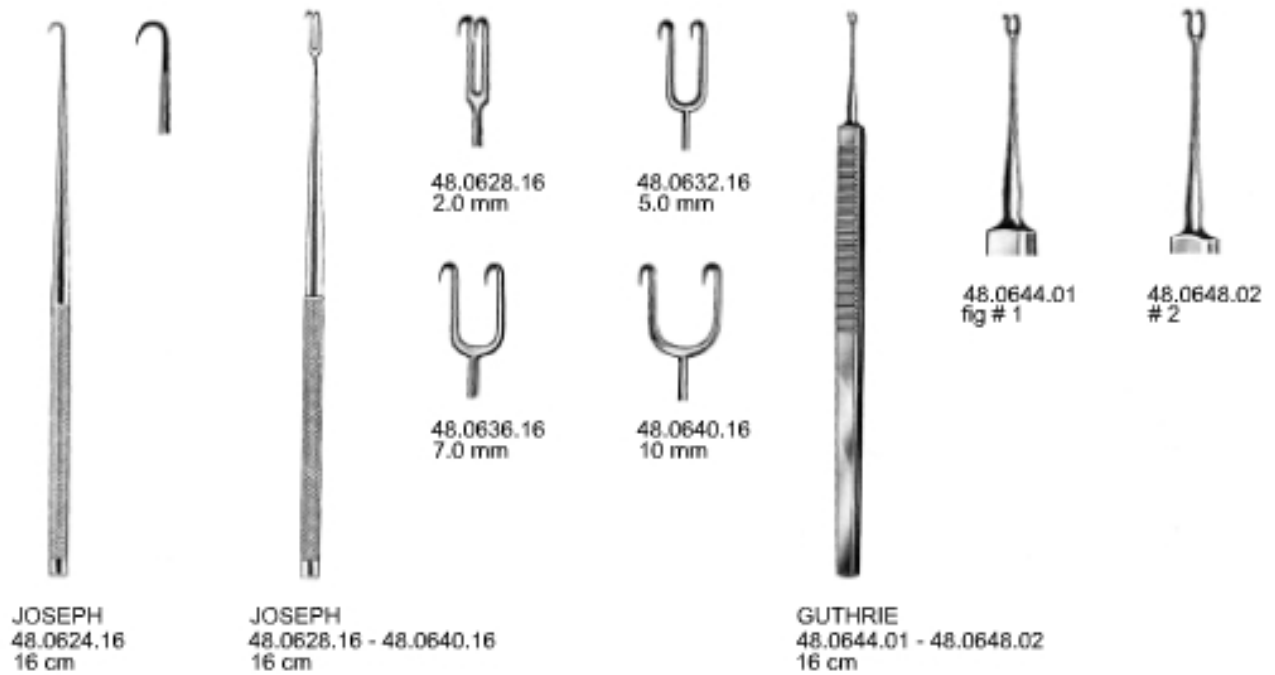
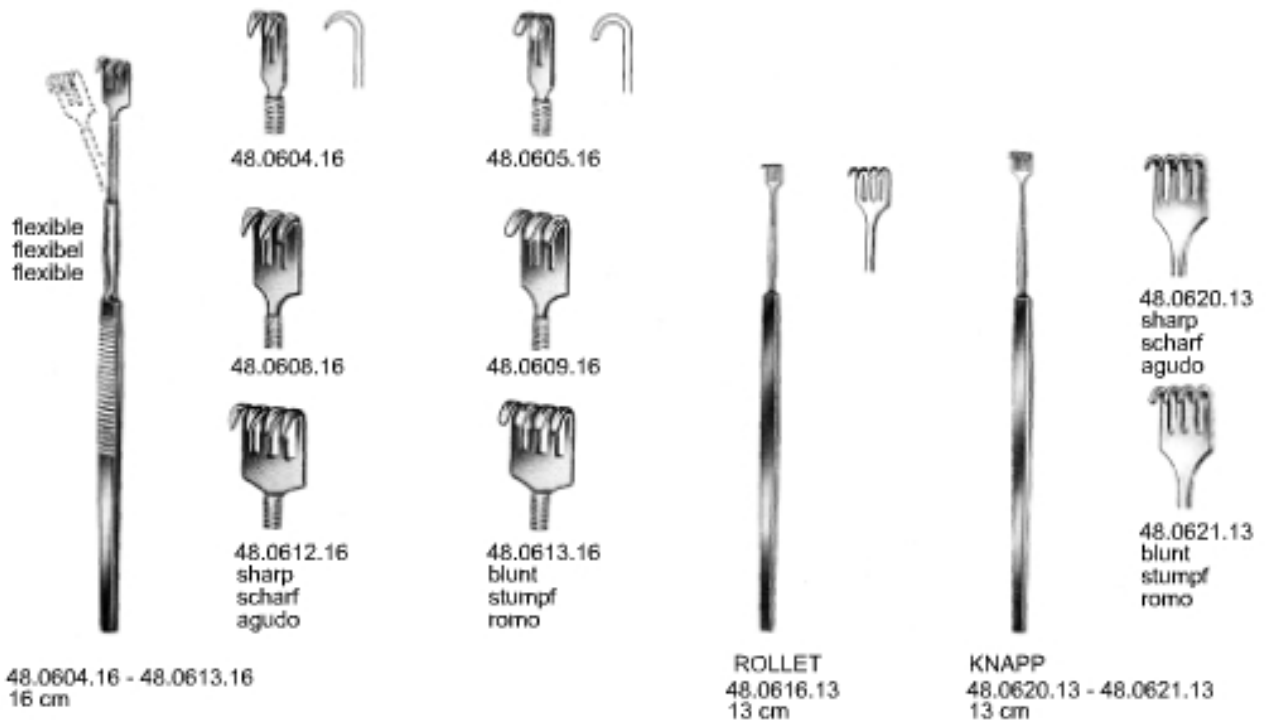



48.0652.15
10 x 6 mm



48.0656.15
20 x 6 mm

SENN-GREEN
48.0652.15 - 48.0656.15
15 cm



48.0660.16
10 x 6 mm



48.0664.16
17 x 5 mm



48.0668.16
20 x 6 mm



48.0672.16
22 x 8 mm

MINI-LANGENBECK
48.0660.16 - 48.0672.16
16 cm



48.0676.25
25 x 7 mm



48.0680.25
25 x 7 mm

48.0676.25 - 48.0680.25
25 cm
(17.043.00)

Retractors
 Wundhaken
 Separadores



DESMARRES
 13 cm



45.1215.01
 10 mm
 Fig - 1



45.1219.02
 12 mm
 Fig - 2



45.1223.03
 14 mm
 Fig - 3



45.1227.04
 16 mm
 Fig - 4



45.1233.05
 18 mm
 Fig - 5



DESMARRES
 48.0708.16 - 48.0728.16



48.0708.16
 8.0 mm



48.0712.16
 10 mm



48.0716.16
 12 mm



48.0720.16
 14 mm



48.0724.16
 16 mm



48.0728.16
 18 mm

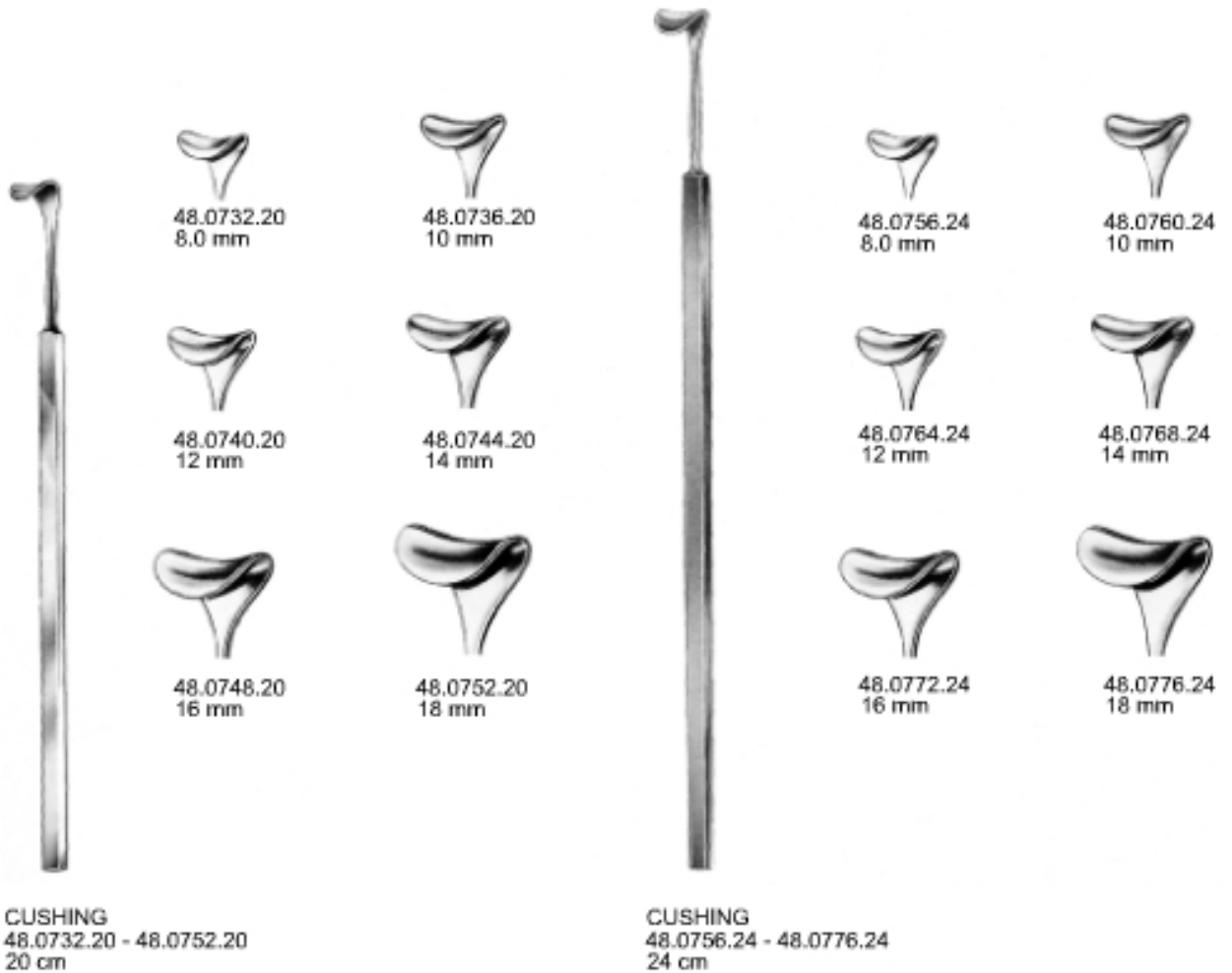

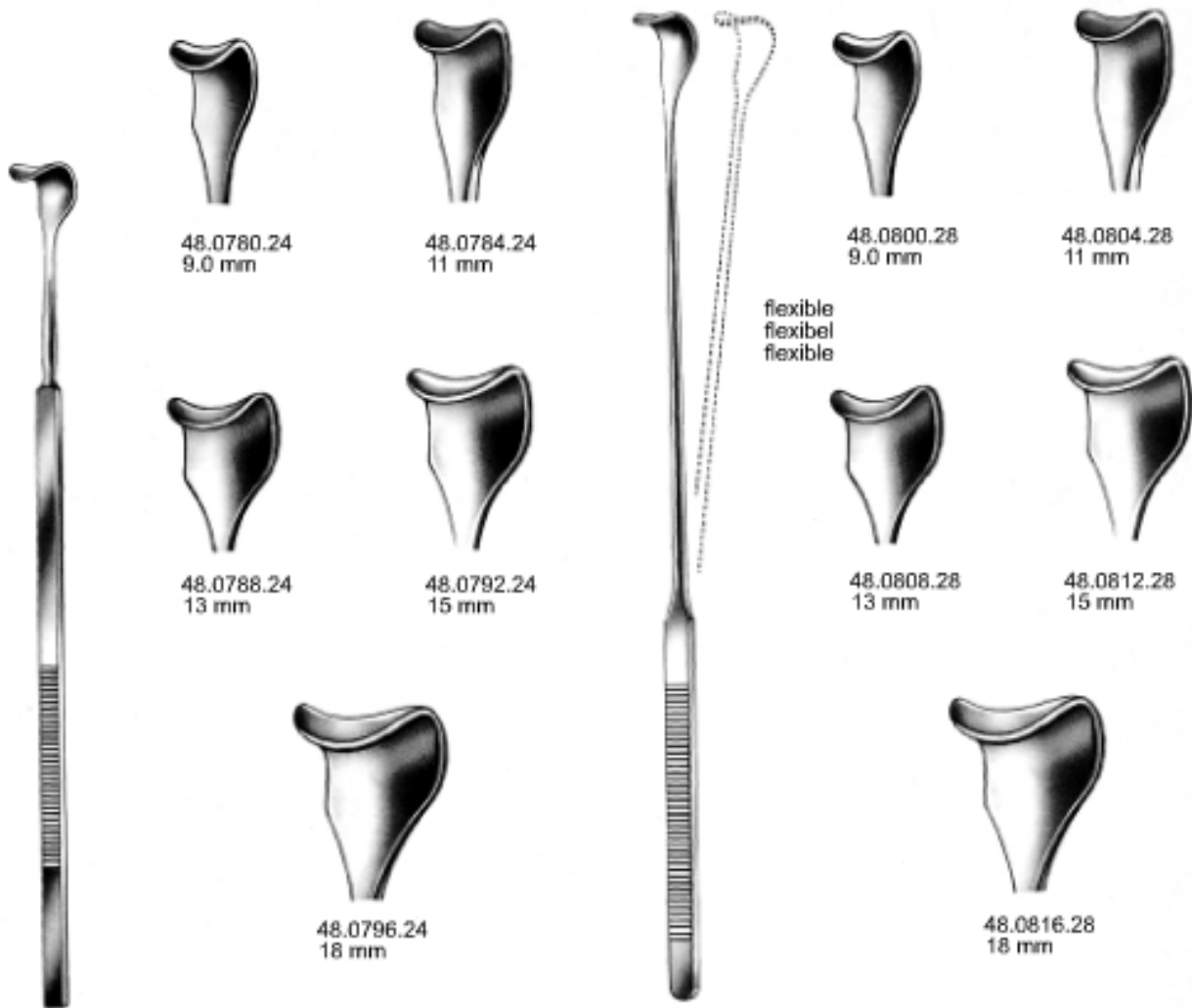

48.0780.24
9.0 mm

48.0784.24
11 mm

48.0800.28
9.0 mm

48.0804.28
11 mm

48.0788.24
13 mm

48.0792.24
15 mm

48.0808.28
13 mm

48.0812.28
15 mm

48.0796.24
18 mm

48.0816.28
18 mm

GILL-VERNET
48.0780.24 - 48.0796.24
24.5 cm

GILL-VERNET
48.0800.28 - 48.0816.28
28 cm





HOESEL
48.0820.25 - 48.0840.25
25 cm



48.0820.25
60 x 20 mm



48.0824.25
80 x 30 mm



48.0828.25
100 x 30 mm



48.0832.25
120 x 30 mm



48.0836.25
140 x 30 mm



48.0840.25
140 x 40 mm



FRITSCH

48.0844.24	24 cm	45 x 40 mm
48.0848.24	24 cm	45 x 50 mm
48.0852.24	24 cm	45 x 60 mm
48.0856.24	24 cm	45 x 75 mm
48.0860.24	24 cm	65 x 85 mm



KOCHER

48.0864.25	22 cm	70 x 25 mm
48.0868.25	25 cm	80 x 42 mm
48.0872.25	25 cm	80 x 50 mm
48.0876.25	25 cm	80 x 60 mm



DOYEN-STILLE

48.0880.24	24 cm	90 x 15 mm
48.0884.24	24 cm	90 x 20 mm
48.0888.24	24 cm	90 x 30 mm
48.0892.24	24 cm	110 x 35 mm
48.0896.24	24 cm	110 x 40 mm
48.0900.24	24 cm	120 x 55 mm

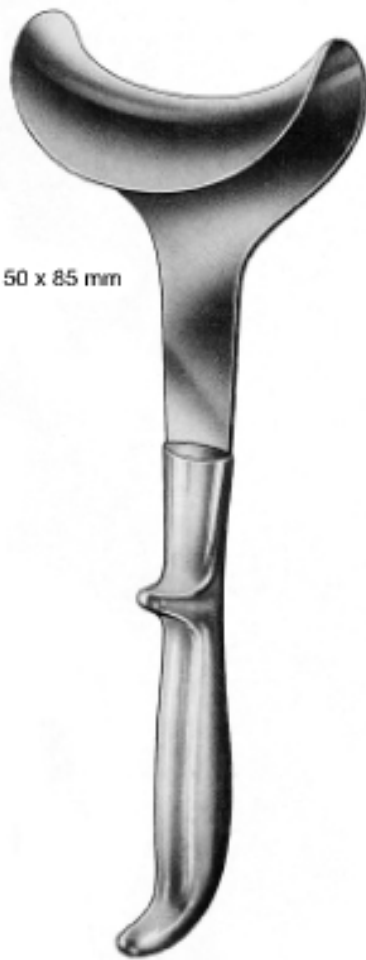
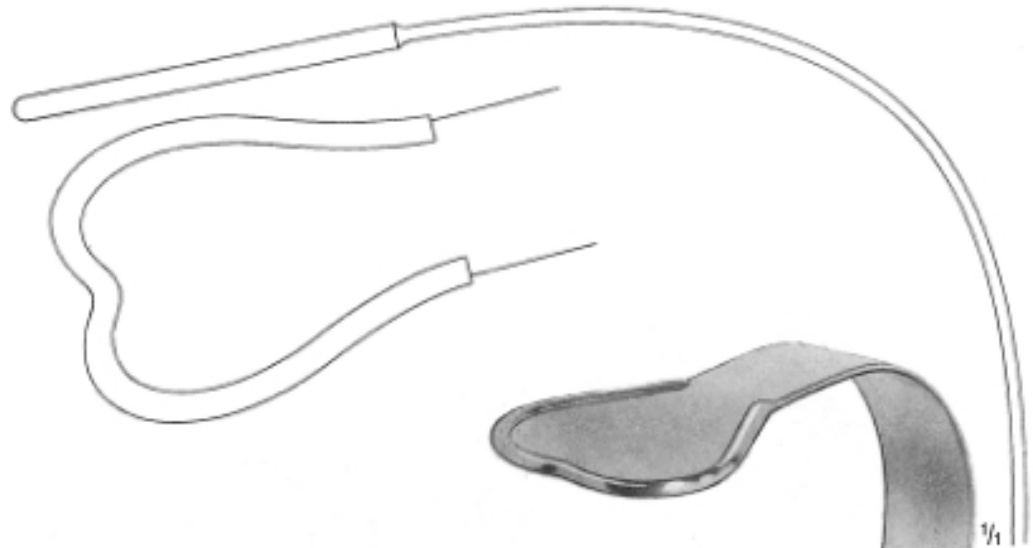

50 x 85 mm

DOYEN
48.0904.25
25 cm



64 x 60 mm

TUFFIER
48.0908.23
23 cm



HARRINGTON
48.0912.32 32 cm 127 x 40 mm
48.0916.32 32 cm 127 x 62 mm
48.0920.32 32 cm 175 x 64 mm



90 x 50 mm

MIKULICZ
48.0924.26
26 cm

MIKULICZ
48.0928.26 26 cm 85 x 35 mm
48.0932.26 26 cm 120 x 50 mm
48.0936.26 26 cm 155 x 50 mm

KELLY
48.0940.27 27 cm 160 x 38 mm
48.0944.27 27 cm 160 x 57 mm
48.0948.27 27 cm 190 x 38 mm
48.0952.27 27 cm 190 x 57 mm





38 mm

DEAVER
48.0980.30
30 cm



50 mm

DEAVER
48.0984.30
30 cm



75 mm

DEAVER
48.0988.30
30 cm

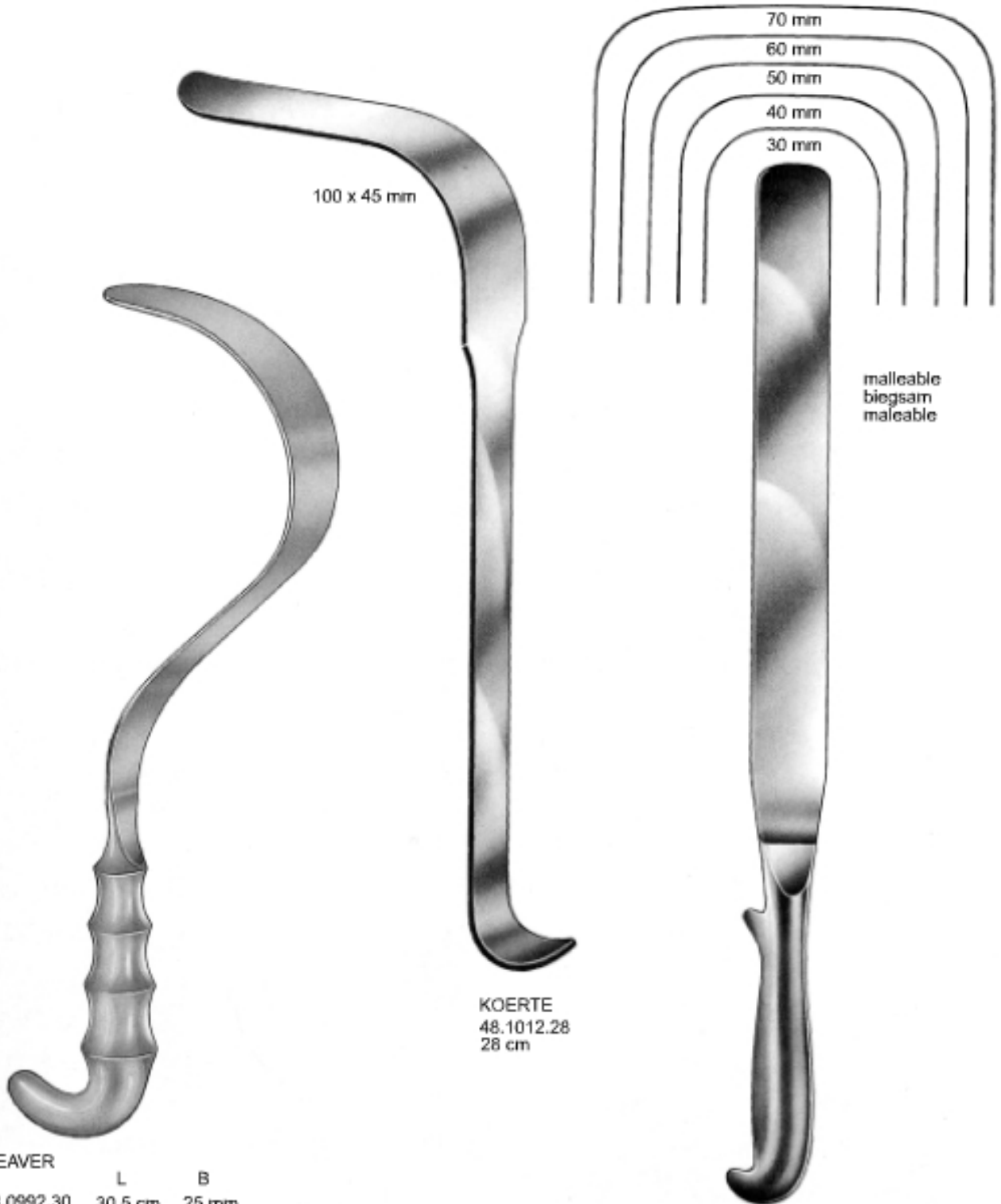

DEAVER

	L	B
48.0992.30	30.5 cm	25 mm
48.0996.33	33 cm	25 mm
48.1000.30	30.5 cm	38 mm
48.1004.30	30.5 cm	50 mm
48.1008.30	30.5 cm	75 mm

KOERTE
48.1012.28
28 cm

48.1016.41	41 cm	245 x 30 mm
48.1020.41	41 cm	245 x 40 mm
48.1024.41	41 cm	245 x 50 mm
48.1028.41	41 cm	245 x 60 mm
48.1032.41	41 cm	245 x 70 mm

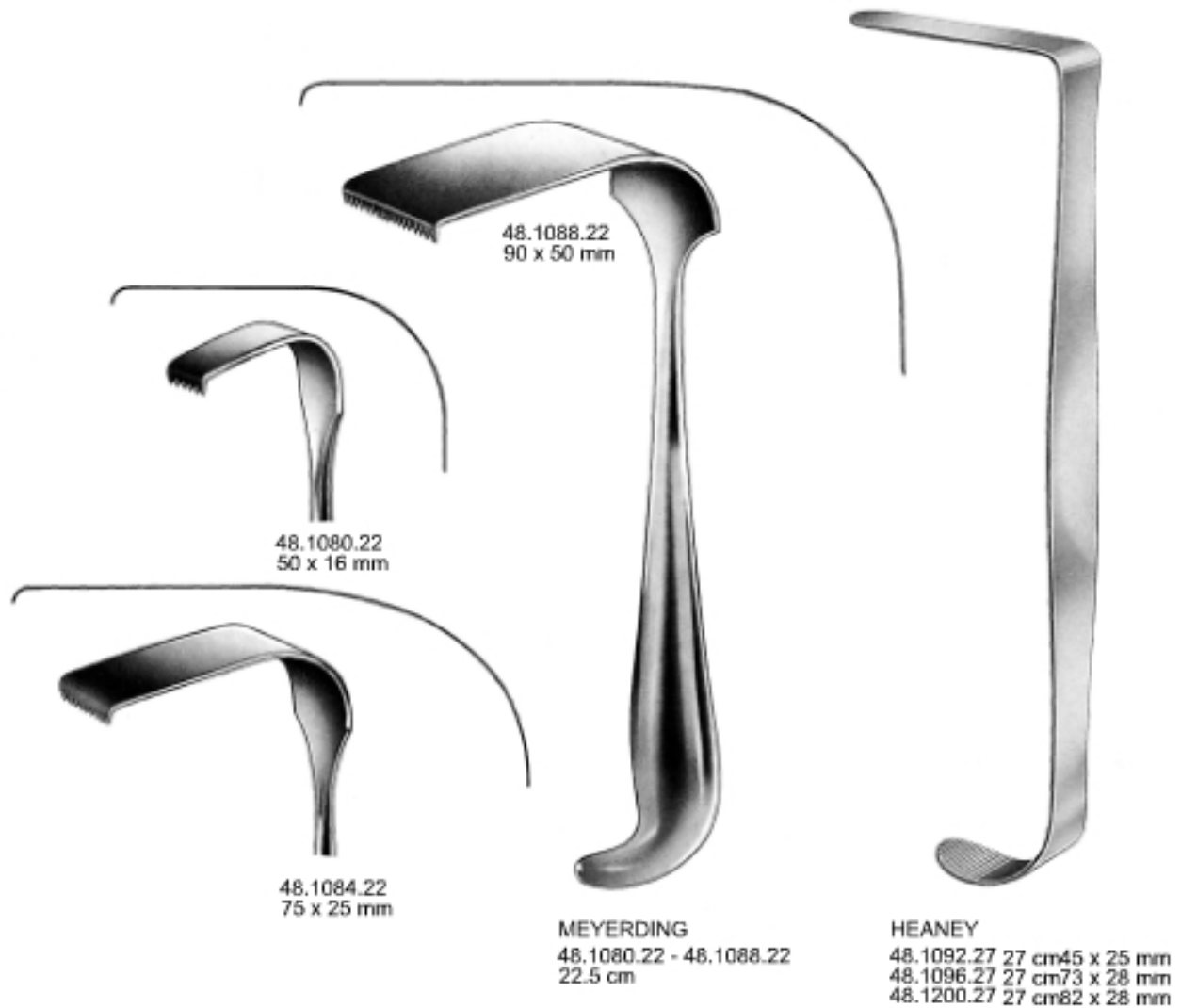

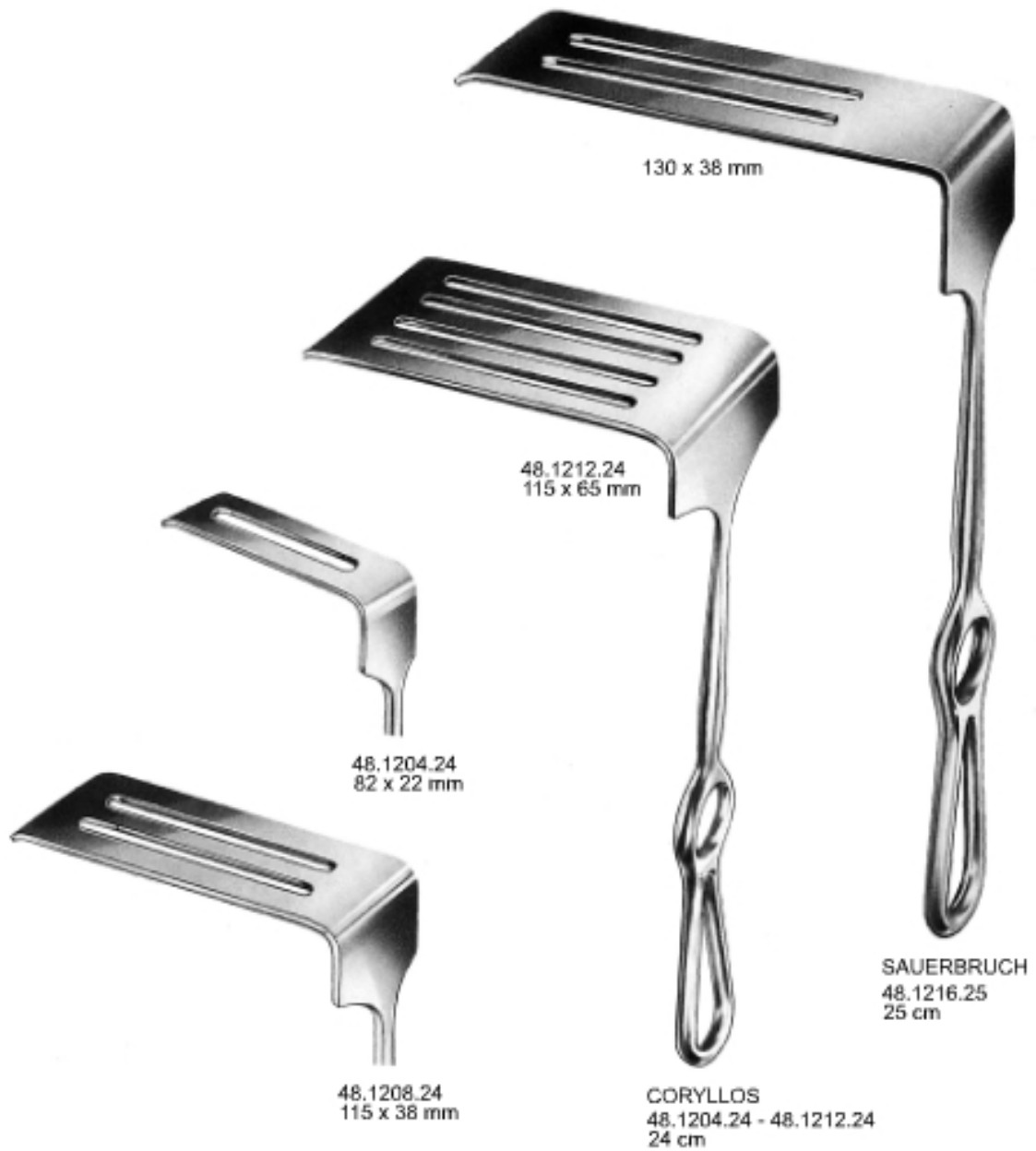

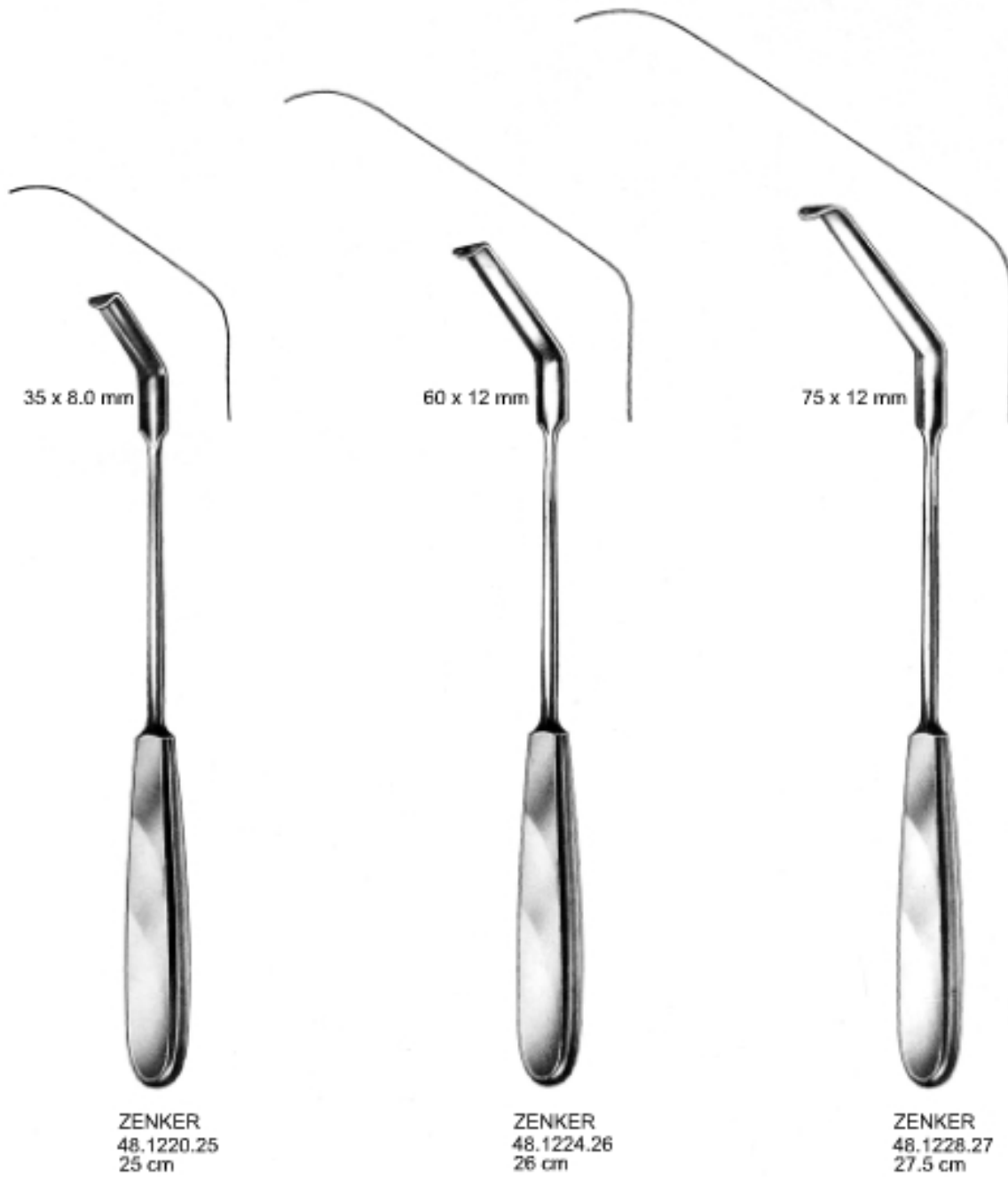





WEITLANER
48.1244.10 10.5 cm
48.1245.13 13.5 cm
sharp-scharf-agudo
(17.001.10)



WEITLANER
48.1248.13
13 cm
sharp-scharf-agudo
(17.002.13)



WEITLANER
48.1253.10
10.5 cm
blunt-stumpf-romo
(17.003.10)



WEITLANER
48.1257.13
13 cm
blunt-stumpf-romo
(17.004.13)



WEITLANER-BABY
48.1260.14
14 cm



JANSEN
48.1264.10 10 cm sharp-scharf-agudo
48.1265.10 10 cm blunt-stumpf-romo



JANSEN
48.1268.10 10 cm sharp-scharf-agudo
48.1269.10 10 cm blunt-stumpf-romo



SNITMAN
48.1272.10 10.5 cm sharp-scharf-agudo
48.1273.10 10.5 cm blunt-stumpf-romo



MILLIGAN
48.1276.13 13 cm sharp-scharf-agudo
48.1277.13 13 cm blunt-stumpf-romo



MOLLISON
48.1280.15 15 cm sharp-scharf-agudo
48.1281.15 15 cm blunt-stumpf-romo



TRAVERS
48.1284.21
21 cm



ANDERSON-ADSON
48.1288.20 20 cm sharp-scharf-agudo
48.1289.20 20 cm blunt-stumpf-romo



WULLSTEIN

- | | | | | | |
|------------|---------|--------------------|------------|---------|-------------------|
| 48.1290.10 | 10.5 cm | sharp-scharf-agudo | 48.1291.10 | 10.5 cm | blunt-stumpf-romo |
| 48.1292.13 | 13 cm | sharp-scharf-agudo | 48.1293.13 | 13 cm | blunt-stumpf- |
| 48.1294.16 | 16 cm | sharp-scharf-agudo | 48.1295.16 | 16 cm | blunt-stumpf-romo |



SCHUHKNECHT

- | | | |
|------------|-------|--------------------|
| 48.1296.14 | 14 cm | sharp-scharf-agudo |
| 48.1297.14 | 14 cm | blunt-stumpf-romo |



PARKER-LANGENBECK
48.1298.21 21 cm



PARKER
48.1300.18 18 cm



MATHIEU
48.1302.20 20 cm



COLLIN-HARTMANN
48.1303.16
16 cm



FARABEUF
48.1304.13
13 cm
(17.012.13)



PARKER
48.1306.13
13 cm



GOELET
48.1308.19
19 cm



FARABEUF
48.1310.15
15 cm



ROUX
48.1312.16
16 cm
set of 3 piece
satz uz 3 stuck
juego de 3 piezas

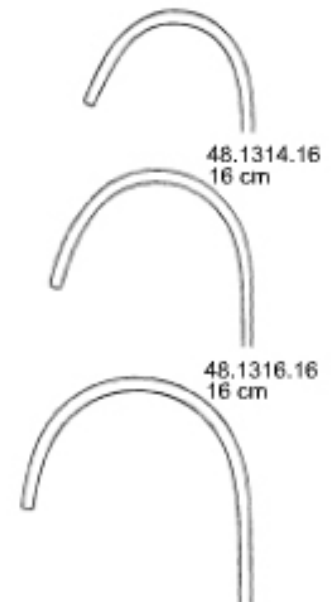

48.1314.16
16 cm

48.1316.16
16 cm

48.1318.16
16 cm



SCALP-CONTOUR
48.1320.14 14 cm sharp-scharf-agudo
48.1321.14 14 cm blunt-stumpf-romo



ADSON
48.1322.20 20 cm cham-ochar-omudo



MISKIMON
48.1324.22 22 cm cham-ochar-omudo



PLESTER

48.1326.10	10 cm	sharp-scharf-agudo	48.1327.10	10 cm	blunt-stumpf-romo
48.1328.13	13 cm	sharp-scharf-agudo	48.1329.13	13 cm	blunt-stumpf-romo



PLESTER-R

48.1331.10	10 cm	blunt-stumpf-romo
48.1333.13	13 cm	blunt-stumpf-romo



PLESTER-L

48.1337.10	10 cm	blunt-stumpf-romo
48.1341.13	13 cm	blunt-stumpf-romo



RIGHBY
48.1340.18 18 cm 35 x 20 mm
48.1344.18 18 cm 60 x 20 mm
48.1348.18 18 cm 65 x 15 mm



57 x 25 mm

70 x 38 mm

DARLING
48.1352.18
18 cm

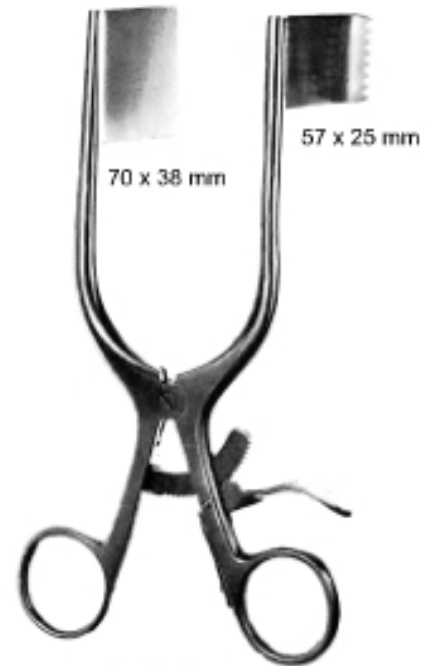

57 x 25 mm

70 x 38 mm

DARLING
48.1356.18
18 cm



BECKMANN-EATON
48.1360.33 33 cm sharp-scharf-agudo
48.1361.33 33 cm blunt-stumpf-romo



GELPI
48.1364.09 9 cm
48.1368.11 11 cm
48.1372.14 14 cm
48.1376.19 19 cm



GELPI
48.1380.19 19 cm



MEYERDING

48.1384.20	20 cm	32 x 25 mm
48.1388.20	20 cm	54 x 25 mm
48.1392.20	20 cm	60 x 19 mm
48.1396.20	20 cm	60 x 25 mm



MARKHAM-MEYERDING
48.1400.18
18 cm



MARKHAM-MEYERDING
48.1404.18
18 cm



BECKMANN

48.1408.31	31 cm	sharp scharf	48.1409.31	31 cm	blunt stumpf	4 x 4	teeth zahne dientes
48.1412.33	33 cm		48.1413.33	33 cm			



CONE

48.1416.13	13 cm	sharp scharf	48.1417.13	13 cm	blunt stumpf
48.1420.16	16.5 cm		48.1421.16	16.5 cm	
48.1424.20	20 cm	agudo romo	48.1425.20	20 cm	
48.1428.25	25 cm		48.1429.25	25 cm	



BECKMANN-ADSON

48.1432.31	31 cm	sharp scharf	48.1433.31	31 cm	blunt stumpf	25 x 25 mm
48.1436.31	31 cm		48.1437.31	31 cm		25 x 30 mm
48.1440.31	31 cm	agudo romo	48.1441.31	31 cm		25 x 40 mm
48.1444.31	31 cm		48.1445.31	31 cm		25 x 45 mm



ADSON
48.1448.27
27 cm



ADSON
48.1452.27
27 cm



ADSON
48.1456.27
27 cm



ADSON
48.1460.27 27 cm sharp-scharf-agudo
48.1461.27 27 cm blunt-stumpf-romo

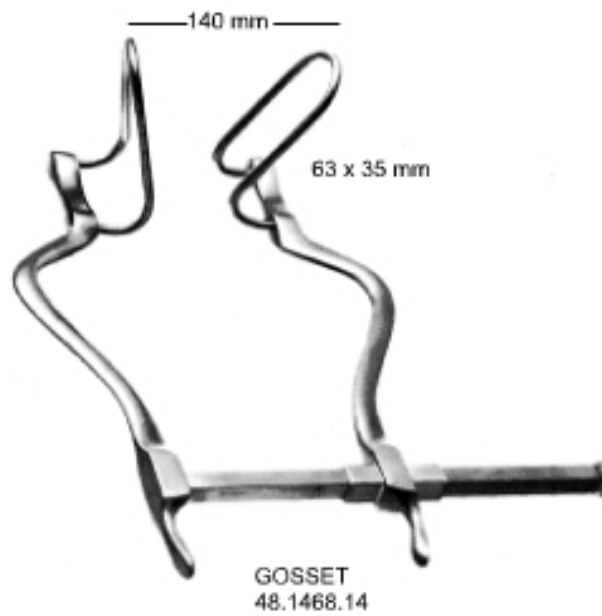
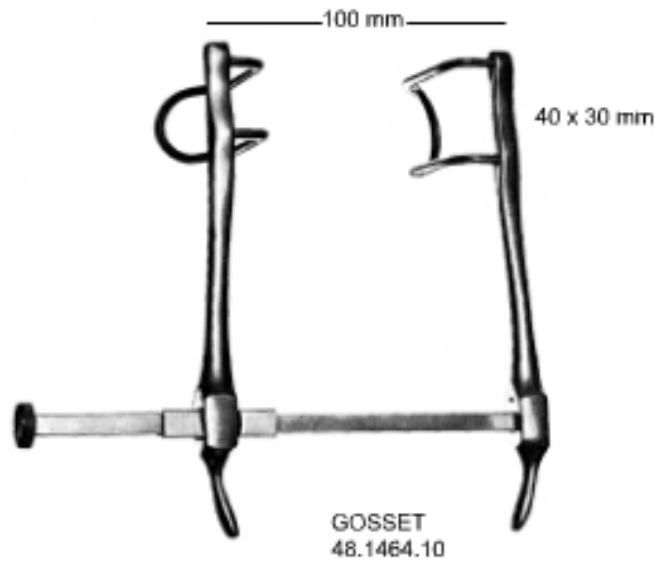

48

Abdominal Retractors
Bauchdeckenhalter
Separadores Abdominales

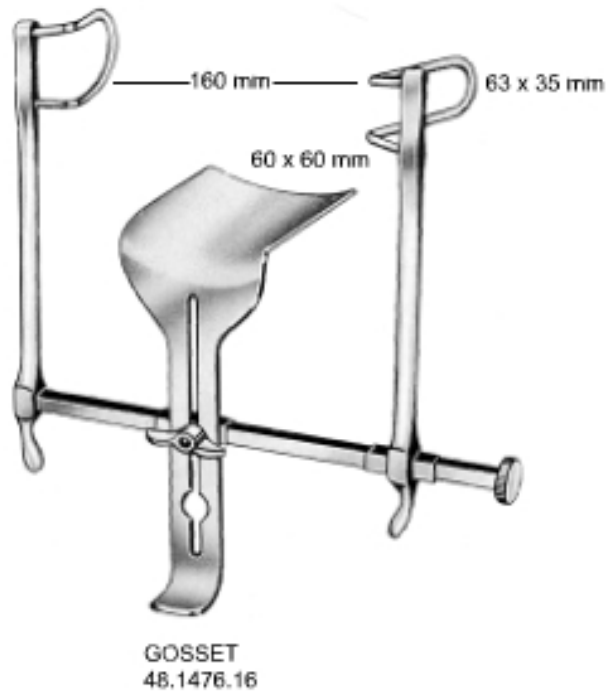
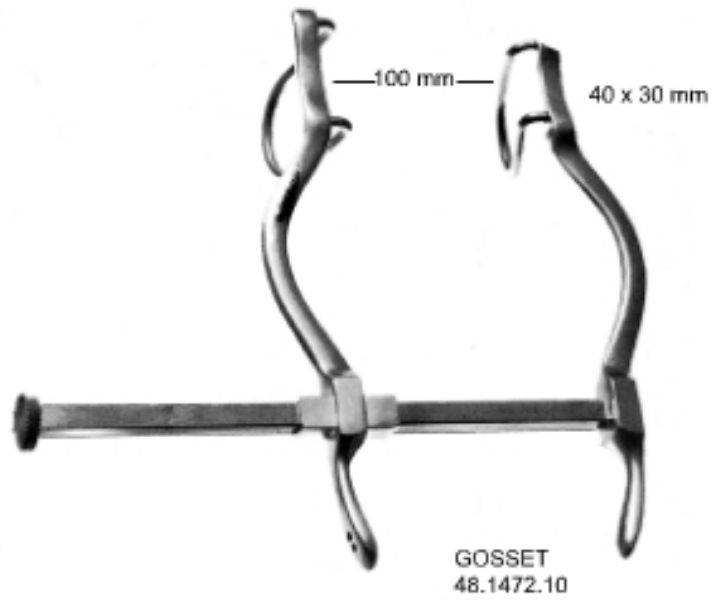

Abdominal Retractors
Bauchdeckenhalter
Separadores Abdominales

48

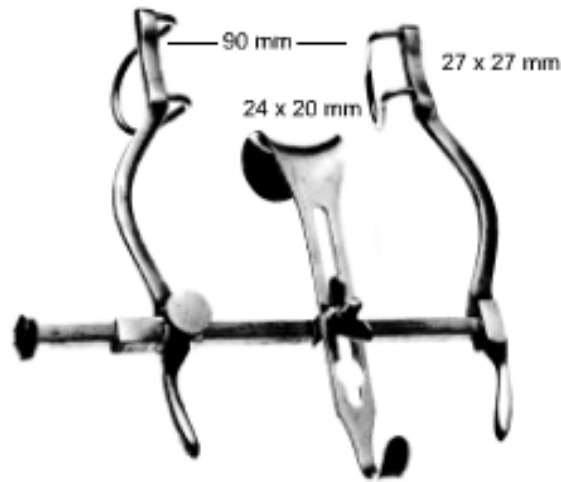

BALFOUR-BABY
48.1480.09

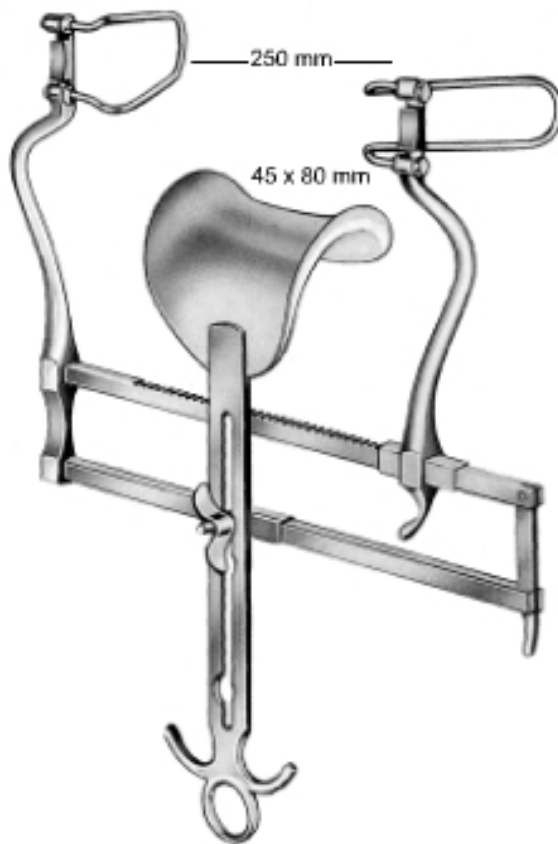

BALFOUR US-TYPE
48.1484.00



48.1488.01
70 x 35 mm



48.1492.02
100 x 35 mm
complete with 2 pairs of blades
komplete mit 2 paar valven
completo con 2 paia divalve



BALFOUR
48.1496.01 45 x 80 mm
48.1500.02 70 x 85 mm
centre blade only
mittelblatt allein
valva central suelta

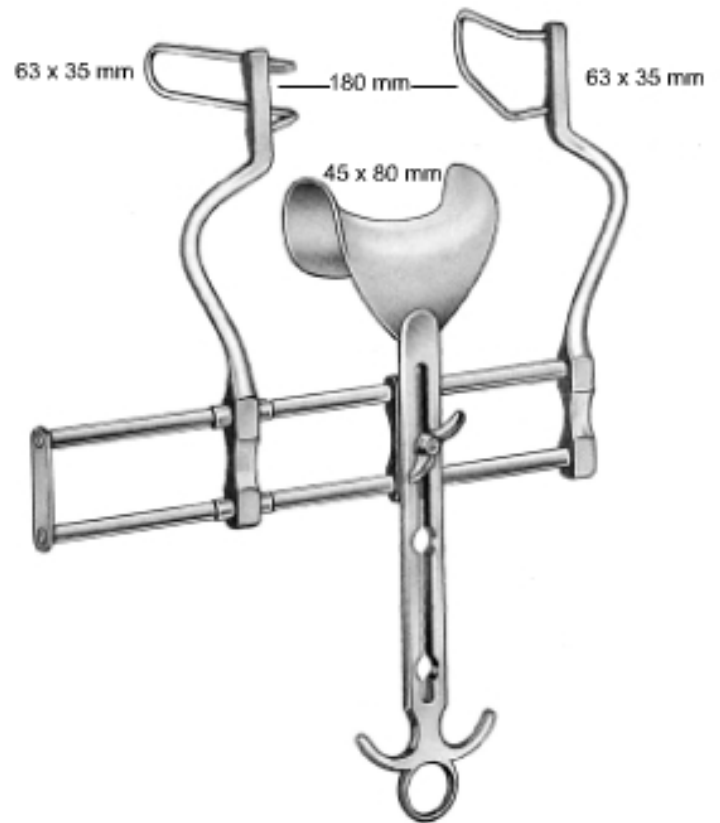

BALFOUR
48.1504.18
18 cm

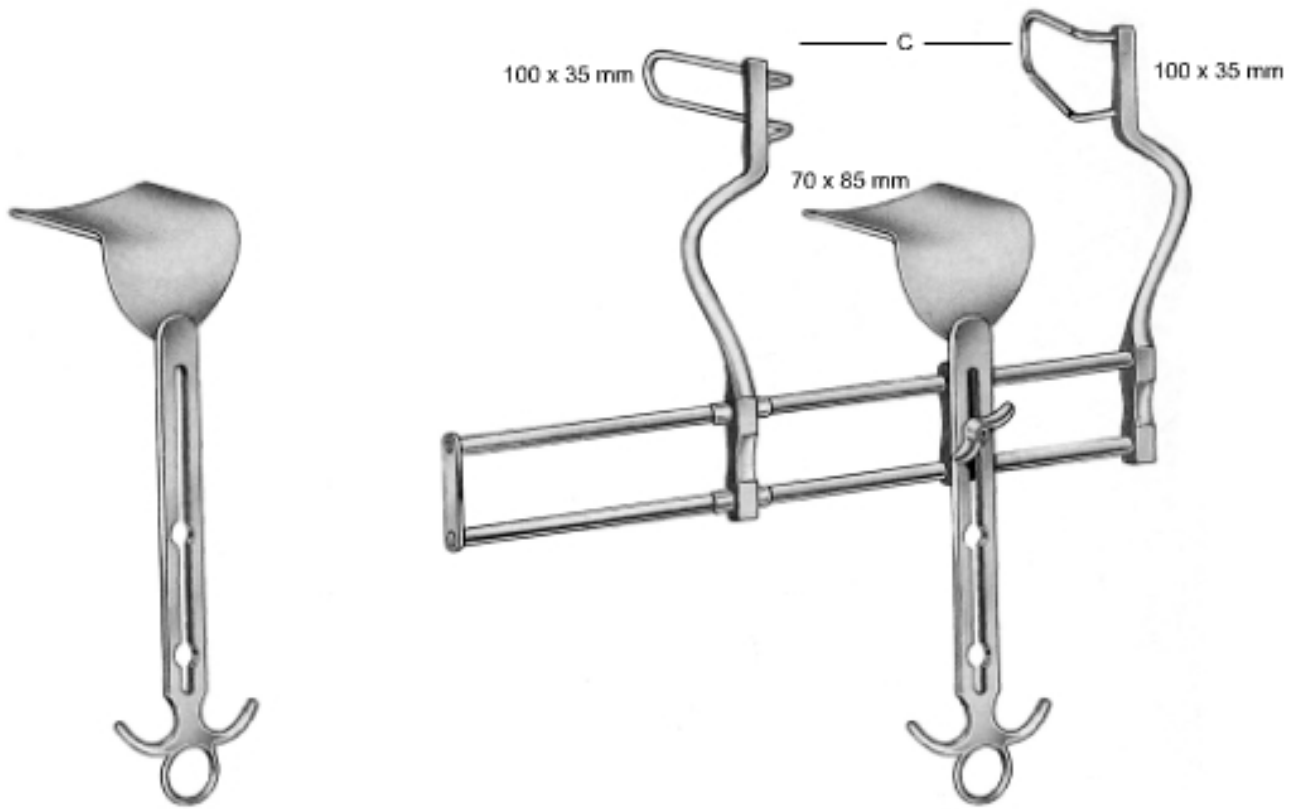

BALFOUR
48.1508.00 100 x 70 mm
centre blade only
mittelblatt allein
valva central suelta

BALFOUR
48.1512.20 20 cm - c
48.1516.25 25 cm - c

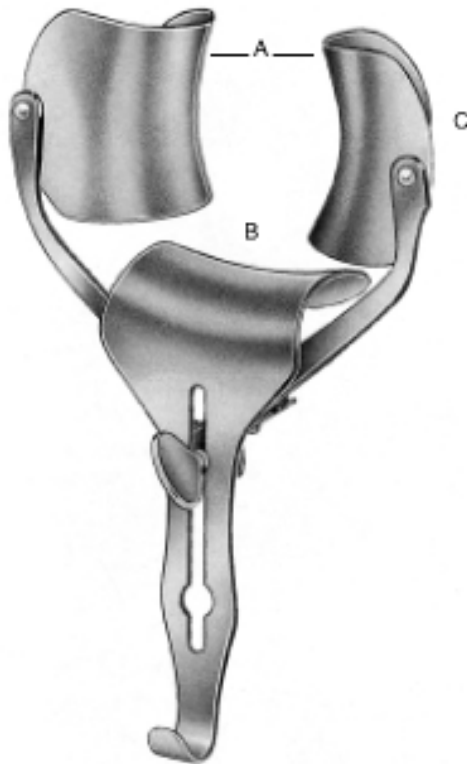

RICARD	A	B	C
48.1520.28	280 mm	80 x 90 mm	72 x 85 mm
48.1524.30	300 mm	55 x 70 mm	60 x 80 mm

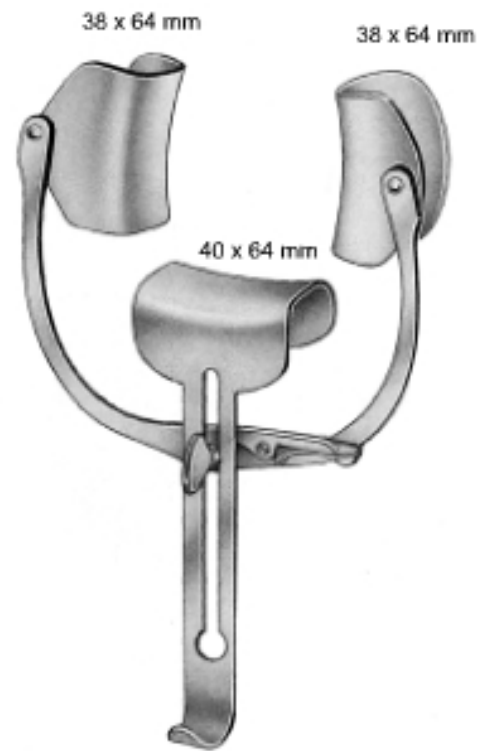

ROBIN - MASSE
48.1528.00

Abdominal Retractors
 Bauchdeckenhalter
 Separadores Abdominales

48



48.1532.06 38 x 62 mm
 48.1536.08 38 x 80 mm
 48.1540.10 38 x 100 mm



48.1544.00 62 x 80 mm

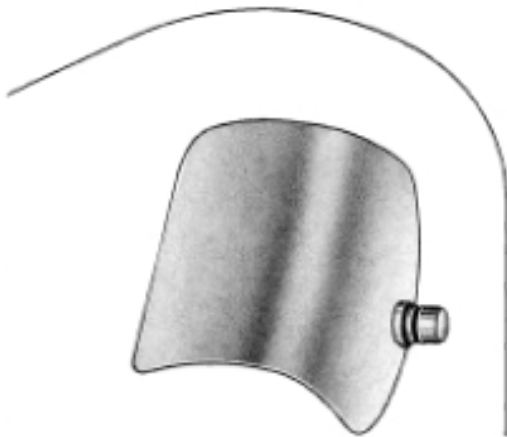

48.1548.00 50 x 58 mm
 48.1552.01 60 x 80 mm
 48.1556.02 72 x 85 mm



48.1560.00 62 x 80 mm



COLLIN-BABY
48.1564.18
18 cm
complete set with 2 pairs of blades
complete mit 2 pares des valvas
completo con 2v pares des valvas



COLLIN
48.1568.22
22 cm

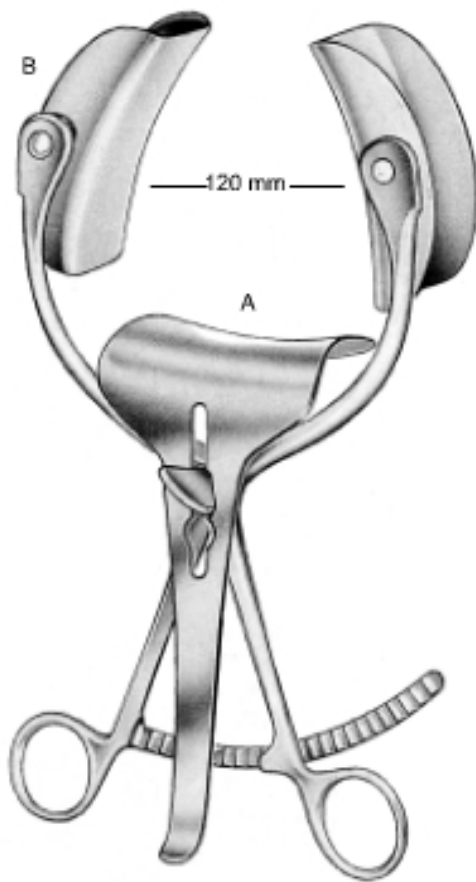

COLLIN	A	B
48.1572.12	55 x 55 mm	38 x 62 mm
48.1576.12	55 x 65 mm	38 x 80 mm
48.1580.12	55 x 75 mm	38 x 100 mm



COLLIN	A	B
48.1584.16	62 x 67 mm	50 x 58 mm
48.1588.16	62 x 67 mm	62 x 80 mm



Otology





GRUBER
49.0102.00 (Fig-2 - 4)
set of 3 pieces
satz zu 3 stuck
juego de 3 piezas

Fig-1
49.0106.01
4.5 mm \varnothing

Fig-2
49.0110.02
5.5 mm \varnothing

Fig-3
49.0114.03
6.5 mm \varnothing

Fig-4
49.0118.04
7.5 mm \varnothing



GRUBER
49.0122.05 (Fig-1 - 4)
set of 4 pieces
satz zu 4 stuck
juego de 4 piezas



GRUBER
49.0126.00 (Fig-2 - 4)
set of 3 pieces
satz zu 3 stuck
juego de 3 piezas

Fig-1
49.0130.01
3.5 x 4.5 mm

Fig-2
49.0134.02
4.5 x 5.5 mm

Fig-3
49.0138.03
5.5 x 6.5 mm

Fig-2
49.0142.04
6.5 x 7.5 mm



GRUBER
49.0146.05 (Fig-1 - 4)
set of 4 pieces
satz zu 4 stuck
juego de 4 piezas



HOLMGREN
49.0150.01 - 49.0154.02

Fig-1
49.0150.01
6 mm \varnothing

Fig-2
49.0154.02
7 mm \varnothing



BOUCHERON
49.0158.00 (Fig-1 - 4)
set of 4 pieces
satz zu 4 stuck
juego de 4 piezas

Fig-1
49.0162.01
4.5 mm \varnothing

Fig-2
49.0166.02
5.5 mm \varnothing

Fig-3
49.0170.03
6.5 mm \varnothing

Fig-4
49.0174.04
7.5 mm \varnothing



ZOELLNER
49.0178.00 (Fig - 1 - 6)
set of 6 piece
satz zu 6 stuck
juego de 6 piezas



Fig-1
49.0182.01
5.5 x 6.5 mm



Fig-2
49.0186.02
6.5 x 7.5 mm



Fig-3
49.0190.03
7.5 x 8.5 mm



Fig-4
49.0194.04
8.5 x 9.5 mm



Fig-5
49.0198.05
9.5 x 10.5 mm



Fig-6
49.0202.06
10.5 x 11.5 mm



49.0206.00 (Fig - 1 - 6)
set of 6 piece
satz zu 6 stuck
juego de 6 piezas



Fig-1
49.0210.01
2 mm Ø



Fig-2
49.0214.02
3 mm Ø



Fig-3
49.0218.03
4 mm Ø



Fig-4
49.0222.04
5 mm Ø



Fig-5
49.0226.05
6 mm Ø



Fig-6
49.0230.06
7.5 mm Ø



Fig-1
49.0238.01
3 mm Ø



Fig-1
49.0254.04
6 mm Ø



Fig-1
49.0270.01
4.5 mm Ø



Fig-2
49.0242.02
4 mm Ø



Fig-2
49.0258.05
7 mm Ø



Fig-2
49.0274.02
5.5 mm Ø



Fig-3
49.0246.03
5 mm Ø



Fig-3
49.0262.06
8 mm Ø



Fig-3
49.0278.03
6.5 mm Ø



TROELTSCH
49.0234.00 (Fig-1 - 3)
set of 3 pieces
satz zu 3 stuck
juego de 3 piezas



TROELTSCH
49.0250.00 (Fig-1 - 3)
set of 3 pieces
satz zu 3 stuck
juego de 3 piezas



ERHARDT
49.0266.00 (Fig-1 - 3)
set of 3 pieces
satz zu 3 stuck
juego de 3 piezas



RICHNAU-HOLMGREN
 49.0282.00 - 49.0294.04

○
 Fig-1
 49.0282.01
 3 mm Ø

○
 Fig-2
 49.0286.02
 4 mm Ø

○
 Fig-3
 49.0290.03
 5 mm Ø

○
 Fig-4
 49.0294.04
 6 mm Ø



POLITZER
 49.0298.00 (Fig-1 - 3)
 set of 3 pieces
 satz zu 3 stuck
 juego de 3 piezas

○
 Fig-1
 49.0302.01
 3 mm Ø

○
 Fig-2
 49.0306.02
 4.5 mm Ø

○
 Fig-3
 49.0310.03
 5.5 mm Ø

○
 Fig-4
 49.0314.04
 6.5 mm Ø



POLITZER
 49.0318.00 (Fig-1 - 4)
 set of 4 pieces
 satz zu 4 stuck
 juego de 4 piezas



Fig-1
49.0326.01
2.5 mm Ø



Fig-2
49.0330.02
4.0 mm Ø



Fig-3
49.0334.03
5.0 mm Ø

HARTMANN
49.0322.00 (Fig-1 - 3)
set of 3 pieces
satz zu 3 stuck
juego de 3 piezas



Fig-1
49.0342.01
5.0 mm Ø



Fig-2
49.0346.02
6.5 mm Ø



Fig-3
49.0350.03
7.5 mm Ø

HARTMANN
49.0338.00 (Fig-1 - 3)
set of 3 pieces
satz zu 3 stuck
juego de 3 piezas



Fig-1
49.0358.01
4.0 mm Ø



Fig-2
49.0362.02
5.0 mm Ø



Fig-3
49.0366.03
6.0 mm Ø



Fig-4
49.0370.04
7.0 mm Ø

TOYNBEE
49.0354.00 (Fig-1 - 3)
set of 3 pieces
satz zu 3 stuck
juego de 3 piezas



TOYNBEE
49.0374.00 (Fig-1 - 4)
set of 4 pieces
satz zu 4 stuck
juego de 4 piezas



HARTMANN
49.0378.00
C⁰-128



HARTMANN
49.0382.00
C¹-256



HARTMANN
49.0386.00
C²-512



HARTMANN
49.0390.00
C³-1024



HARTMANN
49.0394.00
C⁴-2048



HARTMANN
49.0398.00
C⁵-4096



HARTMANN
49.0402.00
C -64



HARTMANN
49.0406.00
C -128



HARTMANN
49.0410.00
C¹-256



LUCAE
49.0412.00
C² - 128



LUCAE
49.0414.00
C³ - 256



LUCAE
49.0416.00
C² - 512



LUCAE
49.0418.00
C³ - 1024



LUCAE
49.0420.00
C⁴ - 2048



LUCAE
49.0422.00
C⁵ - 4096



LUCAE
49.0426.00
a¹ - 435



ALU
49.0428.00
C²-512



ALU
49.0430.00
C³-1024



ALU
49.0432.00
C⁴-2048



ALU
49.0434.00
C⁵-4096

Paracentesis Needles
 Parazentesenadein
 Agujas Para Paracentesis



BARON
 49.0445.00 Ø 1.0 x 75 mm
 49.0449.00 Ø 1.5 x 75 mm
 49.0453.00 Ø 2.0 x 75 mm



WULLSTEIN
 49.0456.16
 16 cm 1.5mm



WULLSTEIN
 49.0460.16 Ø 1.5 mm
 49.0464.16 Ø 2.0 mm
 16 cm



ROSEN
 49.0468.00 Ø 0.70 x 80 mm
 49.0472.00 Ø 0.90 x 80 mm
 49.0476.00 Ø 1.2 x 80 mm



ROSEN
 49.0481.00 Ø 0.70 x 65 mm
 49.0485.00 Ø 0.90 x 65 mm
 49.0489.00 Ø 1.2 x 65 mm



ZÖLLNER
 49.0492.00 0.5 mm Ø
 49.0496.00 0.7 mm Ø
 30 mm



ZÖLLNER
 49.0501.00
 0.7 mm Ø



POLITZER
49.0505.00



POLITZER(Royce)
49.0509.16
16 cm



LUCAE(Royce)
49.0512.18
18 cm



LUCAE(Royce)
49.0516.18
18 cm

Curettes - Kuretten
Curetas Hooks
Schlingen - Haken

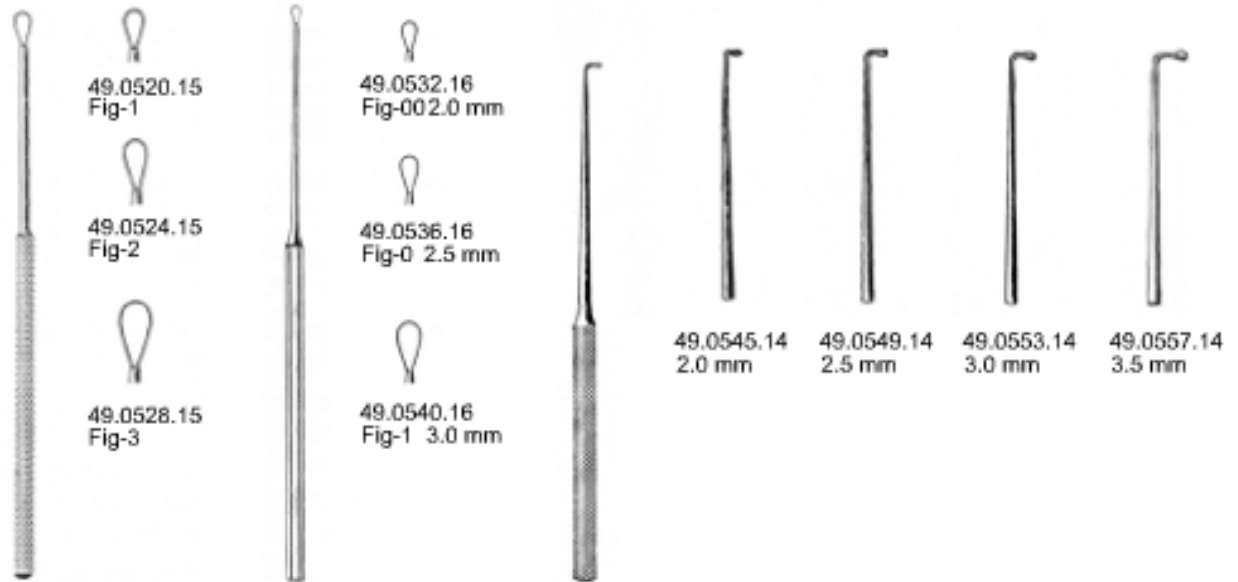

BILLEAU
49.0520.15 - 49.0528.15
15.5 cm

BILLEAU-MICRO
49.0532.16 - 49.0540.16
16 cm

WAGENER
49.0545.14 - 49.0557.14
14 cm

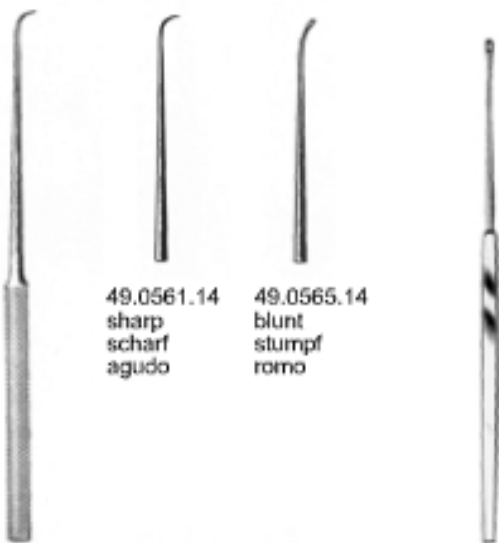

49.0561.14
sharp
scharf
agudo

49.0565.14
blunt
stumpf
romo

49.0568.14
Fig-1

49.0572.14
Fig-2

WAGENER
49.0561.14 - 49.0565.14
14 cm

SHAPLEIGH
49.0568.14 - 49.0572.14
14 cm



MOLDENHAUER
49.0577.16
16 cm

DAY
49.0581.16 - 49.0585.16
16 cm



GROSS
49.0588.12
12 cm
sharp / blunt
scharf / stumpf
agudo / romo



GROSS
49.0592.12
12 cm
blunt / blunt
stumpf / stumpf
romo / romo



GARDINER-BROWN
49.0596.14
14 cm

Fig-0000
1.5 mm

Fig-00
2.2 mm



Fig-000
2 mm

Fig-00
2.2 mm

Fig-0
2.7 mm

Fig-1
3.2 mm



BUCK-WULLSTEIN
MICRO
49.0601.16 Fig-0000
49.0605.16 Fig-000
49.0609.16 Fig-00
49.0613.16 Fig-0
49.0617.16 Fig-1
16 cm
blunt - stumpf - romas



Fig-0
2.5 mm

Fig-1
3 mm

Fig-2
4 mm

Fig-3
4.5 mm

BUCK
49.0620.15 Fig-00
49.0624.15 Fig-0
49.0628.15 Fig-1
49.0632.15 Fig-2
49.0636.15 Fig-3
15 cm
sharp - scharf - cortantes



BUCK
49.0621.15 Fig-00
49.0625.15 Fig-0
49.0629.15 Fig-1
49.0633.15 Fig-2
49.0637.15 Fig-3
15 cm
blunt - stumpf - romas

Paracentesis Needles
 Parazentesenadeln
 Agujas Para Paracentesis

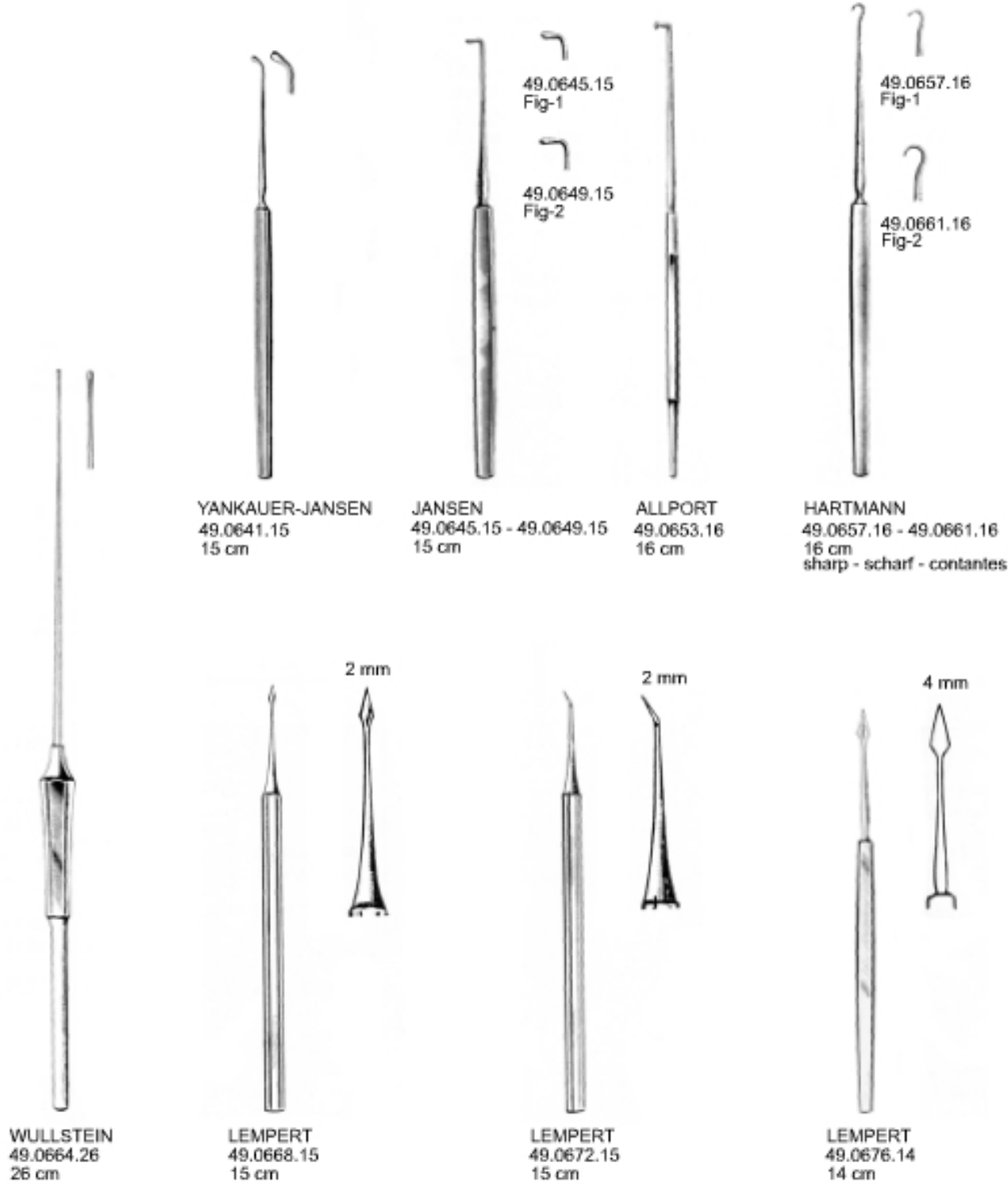

YANKAUER-JANSEN
 49.0641.15
 15 cm

JANSEN
 49.0645.15 - 49.0649.15
 15 cm

ALLPORT
 49.0653.16
 16 cm

HARTMANN
 49.0657.16 - 49.0661.16
 16 cm
 sharp - scharf - contantes

WULLSTEIN
 49.0664.26
 26 cm

LEMPERT
 49.0668.15
 15 cm

LEMPERT
 49.0672.15
 15 cm

LEMPERT
 49.0676.14
 14 cm

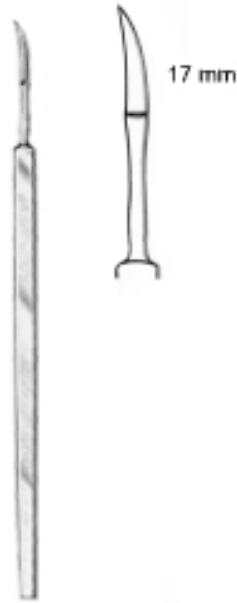

LEMPERT
49.0681.16
16 cm

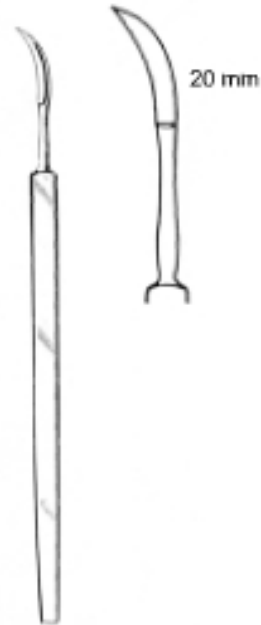

LEMPERT
49.0685.17
17 cm



POLITZER
49.0689.16
16 cm



BUCK
49.0693.15
15 cm

Ear Syringe, Suction Tubes
 Ohrspritzen, Saugrohre
 Jeringas para los oídos, Tubos de aspiración



HARTMANN 49.0697.00 HARTMANN 49.0701.00



49.0713.00 50 ml
 49.0717.04 100 ml
 Ear syringe, complete
 Ohrspritze, komplett
 Jeringa para los oídos, complete



YANKAUER
 49.0721.28
 28.5 cm
 Tonsil Suction Tube
 with central boring



FRAZIER (Fergusson)
 49.0705.00 Ø 1.0 x 190 mm
 49.0709.00 Ø 2.0 x 190 mm

49

Ear Polypus Forceps, Foreign Body Levers
Polypenzangchen, Fremdkörperheber
Pinzas para polipos, Elevadores para cuerpos extraños



QUIRE
49.0724.00
10 cm



BUCK
49.0728.00
11 cm



HARTMANN
49.0732.13
13 cm



HARTMANN
49.0736.13
13 cm



LITTAUER
49.0740.13
13 cm

Micro Ear Scissors
 Mikro Ohscherchen
 Tijeras Auriculares Micro



BELLUCCI
 49.0744.11 - 49.0760.17



49.0744.11
 sharp - blunt - straight
 spitz - stumpf - gerade
 agudo - romo - recta



49.0748.12
 sharp - sharp - straight
 spitz - spitz - gerade
 agudo - agudo - recta



49.0752.13
 sharp angled upwards
 spitz, nach oben abgewinkelt
 agudo angulado hacia arriba



49.0756.16
 sharp, curved to right
 spitz, nach rechts gebogen
 agudo, curvo hacia derecha



49.0760.17
 sharp, curved to left
 spitz, nach links gebogen
 agudo, curvo hacia izquierda



SHEA-BELLUCCI
 49.0764.10 - 49.0776.17



49.0764.10
 blunt - blunt - straight
 stumpf - stumpf - gerade
 romo - romo - recto



49.0768.12
 sharp - sharp - straight
 spitz - spitz - gerade
 agudo - agudo - recta



49.0772.16
 semi - sharp, bent to right
 halbspitz, nach rechts gebogen
 medi - agudo, curvo hacia derecha



49.0776.17
 semi - sharp, bent to left
 halbspitz, nach links gebogen
 medi - agudo, curvo hacia izquierda

49

Micro Ear Forceps
 Mikro Ohscherchen
 Pinzas Auriculares

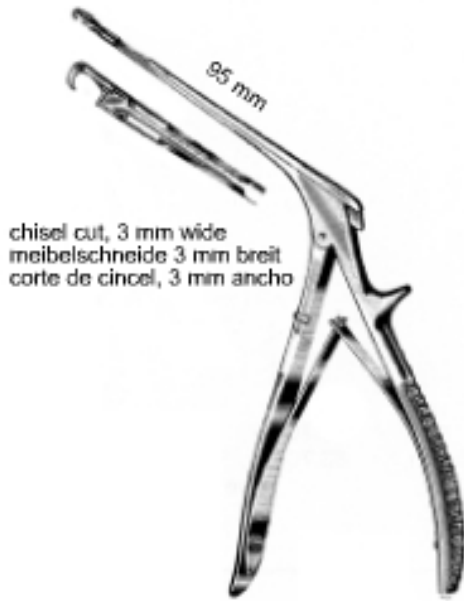

chisel cut, 3 mm wide
 meibelschneide 3 mm breit
 corte de cincel, 3 mm ancho

LEMPERT
 49.0780.00



WULLSTEIN
 49.0784.00
 chisel cut, 3 mm long
 meibelschneide 3 mm lang
 corte de cincel, 3 mm ancho

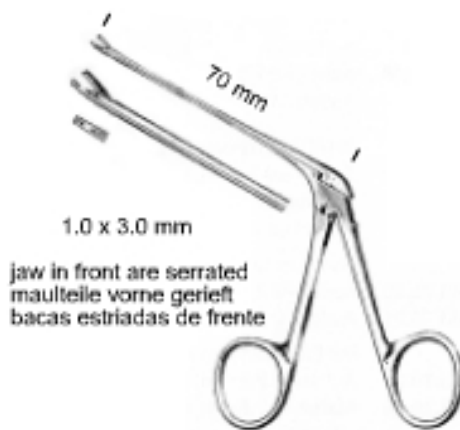

1.0 x 3.0 mm
 jaw in front are serrated
 mauteile vorne gerieft
 bocas estriadas de frente

GREVEN
 49.0788.00



MEHMKE
 49.0792.00

Ear Polypus Forceps
Ohr - Polypenzangen
Pinzas Para Plipos Aturiculares

49

- | | | | |
|------------|------------|------------|------------|
| | | | |
| 49.0800.00 | 49.0804.00 | 49.0808.00 | 49.0812.00 |
| 2 mm | 2.2 mm | 2.5 mm | 3 mm |

HARTMANN-HERZFELD



HARTMANN
49.0816.12
serrated jaws
geriefte maulteile
bocas estriadas



HARTMANN-NOYES
49.0820.00
2.5 x 15 mm
serrated
geriefte
estriadas

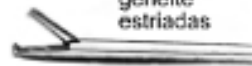

HARTMANN
49.0824.00
1 x 2 teeth - zahne - dientes
serrated - geriefte - estriadas



HARTMANN
49.0828.00
2 x 7 mm
spoon shaped jaws
loffelmaul
bocas de cuchara



ENTENSCHNABEL
49.0832.00
2 mm
wide
breit
ancho

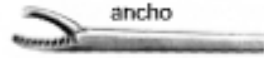

WEINGARTNER
49.0836.00
concave serrated
konkav gerieft
concavos estriadas

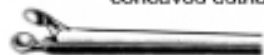

HARTMANN-HERZFELD
49.0840.00
round spoon shape jaws
mit runden loffel maul
rebondas de cuchare



STRUEMPEL
49.0844.00
2.5 x 5 mm
pointed oval spoon jaws
spitz-ovalem-loffelmaul
agudas forma cuchara



TILLEY
49.0796.14
14 cm
serrated jaws 65 mm long
geriefte maul 65 mm lang
estriadas bocas 65 mm ancho





HARTMANN
49.0848.00 - 49.0852.00



49.0848.00
1.2 mm
smooth
glatt
lisas

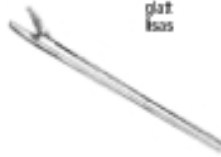

49.0852.00
1.2 mm
1 x 2 teeth-zahne dientes
smooth
glatt
lisas



HARTMANN
49.0856.00 - 49.0860.00



49.0856.00
serrated - gerieft - estrías



49.0860.00
serrated jaw angled upward
mautkelle gerieft nach oben abgewinkelt
bocas estrías angula dohacia arriba



1.8 x 10 mm
serrated jaws
pointe moul
bocas estrías

BELLUCCI
49.0864.00

Ear Polypus Forceps
Ohr-Polypenzangen
Pinzas para Polipos Auriculares

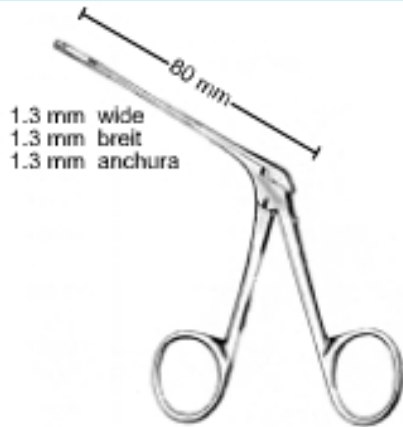

1.3 mm wide
1.3 mm breit
1.3 mm anchura

DIETER
49.0868.00 - 49.0880.00



49.0868.00
cutting to right
nach rechts schneidend
corpalbo hacia derecha



49.0872.00
cutting to left
nach links schneidend
cortado hacia izquierda



49.0876.00
upwards cutting
nach oben schneidend
cortando hacia arriba



49.0880.00
downwards cutting
nach unten schneidend
cortando hacia abajo



DAVAL
49.0882.00



MCGEE
49.0884.14-49.0888.15

49.0884.14
0.8 x 3.5 mm
short jaws
kurzem maul
bocas cortas

49.0888.15
0.8 x 6 mm
long jaws
langem maul
bocas largas

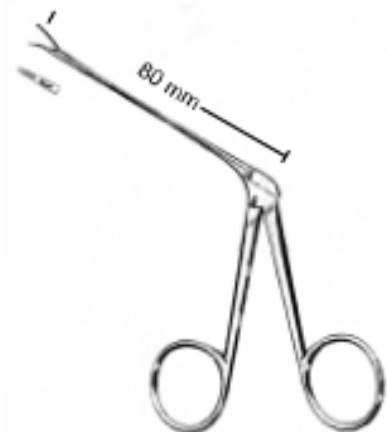

SCHUKNECHT
49.0892.00
0.8 x 6 mm
jaws slightly bent downwards
maulteile leicht nach unten gebogen
bocjas ligeramente curvas hacia abajo



49.0896.12
0.5 x 0.6 mm
straight
gerade
recto



49.0900.14
0.5 x 0.6 mm
angled upwards
nach oben abgewinkelt
anguladas hacia arriba



49.0904.16
0.5 x 0.6 mm
angled to right
nach rechts abgewinkelt
anguladas hacia derecha

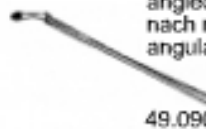

49.0908.17
0.5 x 0.6 mm
angled to left
nach links abgewinkelt
anguladas hacia izquierda

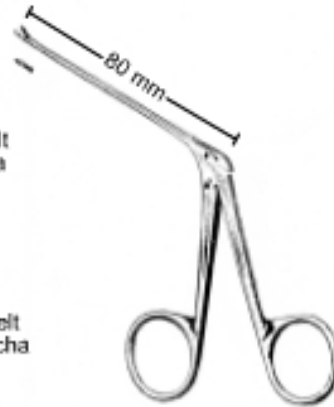

SUPER FINE
49.0896.12 - 49.0908.17
spoon forcep
loffel zangchen
pinza forma cuchara



49.0912.12
0.9 x 1.0 mm
straight
gerade
recto



49.0916.14
0.9 x 1.0 mm
angled upwards
nach oben abgewinkelt
anguladas hacia arriba

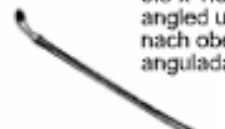

49.0920.16
0.9 x 1.0 mm
angled to right
nach rechts abgewinkelt
anguladas hacia derecha



49.0924.17
0.9 x 1.0 mm
angle to left
nach links abgewinkelt
anguladas hacia izquierda



49.0912.12 - 49.0924.17
spoon forcep
loffel zangchen
pinza forma cuchara

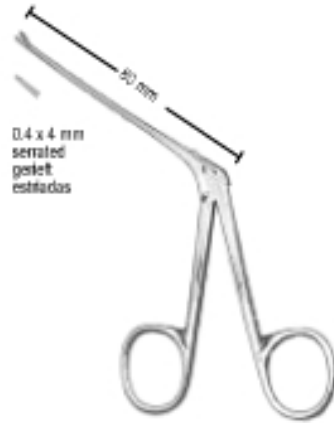

SUPER FINE
49.0928.00

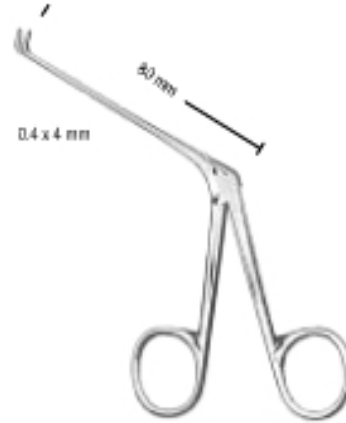

SUPER FINE
49.0932.00
serrated angle upward
gestift nach oben abgewinkelt
estriadas angulado hacia arriba



49.0936.00
0.5 x 4 mm
smooth
glatt
lisas



49.0948.00
0.5 x 3 mm
serrated angled to right
gestift nach rechts abgewinkelt
estriadas anguladas hacia derecha



49.0940.00
0.5 x 4 mm
serrated
gestift
estriadas



49.0952.00
0.5 x 3 mm
angle to left
nach links abgewinkelt
anguladas hacia izquierda



49.0944.00
0.5 x 3 mm
serrated angled upwards
gestift nach oben abgewinkelt
estriadas angulado hacia arriba



49.0956.00
0.5 x 8 mm
serrated extra long
gestift extra lange
estriadas extra largas



49.0936.00 - 49.0956.00



Rhinology



Ear and Nose Dressing Forceps
 Ohr - und Nasenpinzetten
 Pinzas auriculares y nasales



LUCAE 1:2
 50.0102.14
 14 cm



50.0104.16 16 cm
 50.0106.18 18 cm
 50.0108.20 20 cm

JANSEN
 50.0104.16 - 50.0108.20



LUCAE
 50.0110.14
 14 cm



50.0101.12 12 cm
 50.0103.15 15 cm
 50.0105.18 18 cm

TROELTSCH (WILDE) 1:2
 50.0101.12 - 50.0105.18



50.0107.11 11 cm
 50.0109.12 12 cm
 50.0111.15 15 cm
 50.0113.18 18 cm

TROELTSCH (WILDE)
 50.0107.11 - 50.0113.18



50.0115.11 11 cm
 50.0117.13 13 cm

TROELTSCH (WILDE)
 50.0115.11 - 50.0117.13

3.5 mm
wide
breit
ancho



KILLIAN
50.0118.18
18 cm
sharp / blunt
scharf / stumpf
agudo / romo

5.0 mm
wide
breit
ancho



KILLIAN
50.0119.23
23 cm



HAJEK-BALLEGER
50.0120.20
20 cm



HOWARTH
50.0121.21
21 cm



KISTNER
50.0123.17 - 49.0125.17
17 cm



PENNINGTON
50.0127.20
20 cm



PIERCE
50.0131.20
20 cm



LANGE
50.0135.23
23 cm

Adenoid Currettes
 Rinamesser
 Cuchillos para vegetaciones adenoides

50



BECKMANN
 50.0138.01 - 50.0158.06
 20 cm



1/4

50.0138.01



1/4

50.0142.02



1/4

50.0146.03



1/4

50.0154.04



1/4

50.0156.05



1/4

50.0158.06



1/2

NEGUS KNOT PUSHER
 50.0162.00
 20 cm



GWYNNE EVANS DISSECTOR
 50.0166.00
 8 mm x 20 cm
 serrated
 gireli
 estriado

50

Septum Scissor
Septumscheren
Tijeras de Septum



TOENNIS-ADSON
50.0171.17
17.5 cm



COTTLE
50.0175.16
16 cm



FOMON
50.0179.15
15 cm

Septum Scissors And Septum Knives
 Septumscheren und septummesser
 Tijeras de Septum y Bisturios Para el Tabique Nasal



Fig-1
3 mm



Fig-2
4 mm



Fig-3
5 mm



BALLENGER
 50.0182.01 3 mm Fig-1
 50.0186.02 4 mm Fig-2
 50.0190.03 5 mm Fig-3
 19 cm

BALLENGER
 50.0194.01 3 mm Fig-1
 50.0198.02 4 mm Fig-2
 50.0202.03 5 mm Fig-3
 20 cm



HEYMANN
 50.0206.17
 17 cm



HEYMANN
 50.0210.17
 17 cm



serrated
 gerieft
 estriadas

SEILER
 50.0214.17
 17 cm



WALTON-VIENNA
50.0218.14
14 cm



WIENNA MODEL
50.0222.01 Fig-1
50.0226.02 Fig-2
50.0230.03 Fig-3
15 cm



Fig-1



Fig-2



Fig-3



WIENNA MODEL
50.0234.01 Fig-1
50.0238.02 Fig-2
50.0242.03 Fig-3
14 cm



Fig-1



Fig-2



Fig-3

Nasal Speculum
Nasenspekula
Especulos Nasales



BECKMANN
50.0245.01
50.0249.02
50.0253.03
50.0257.04
15 cm

Fig-1
Fig-2
Fig-3
Fig-4



Fig-1



Fig-2



Fig-3



Fig-4



WIENER MODEL
50.0260.01 Fig-1
50.0264.02 Fig-2
13 cm



Fig-1



Fig-2



VOLTOLINI
(DUPLAY)
50.0268.01
50.0272.02
50.0276.03
15 cm

Fig-1
Fig-2
Fig-3



FRAENKEL
50.0280.08
8 cm



HARTMANN-HALLE
50.0284.01 Fig-1
50.0292.02 Fig-2
50.0300.03 Fig-3
15 cm

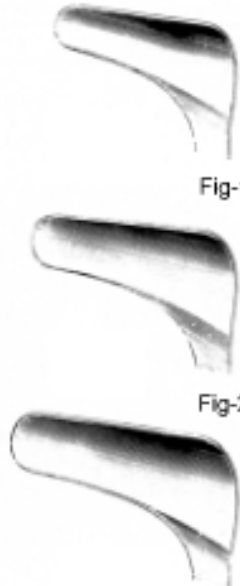

Fig-1

Fig-2

Fig-3



HARTMANN-HALLE
50.0288.01 Fig-1
50.0296.02 Fig-2
50.0304.03 Fig-3
15 cm



TIECK-HALLE
50.0308.01 Fig-1
50.0312.02 Fig-2
13.5 cm



Fig-1



Fig-2



HARTMANN
50.0316.01 Fig-1
50.0320.02 Fig-2
50.0324.03 Fig-3
15 cm



Fig-1



Fig-2

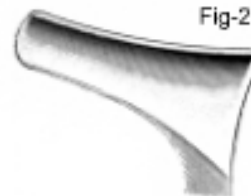
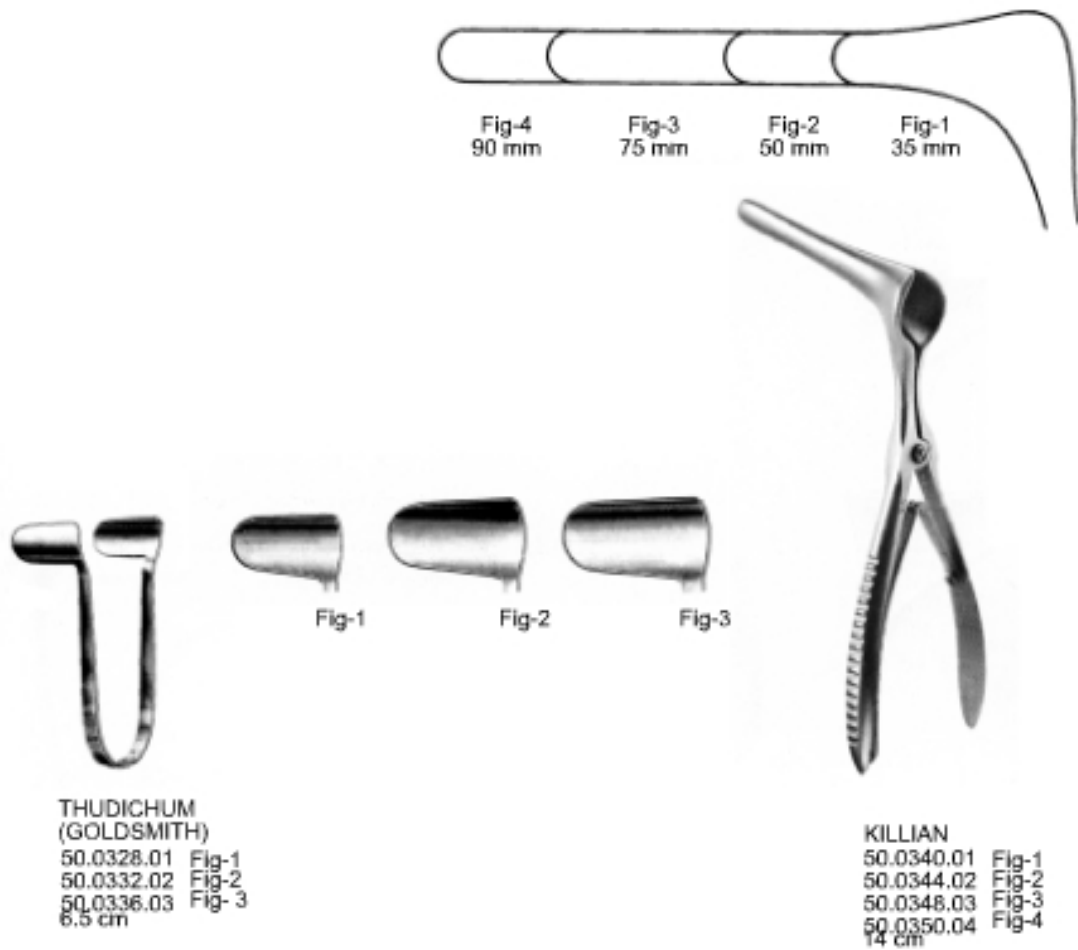
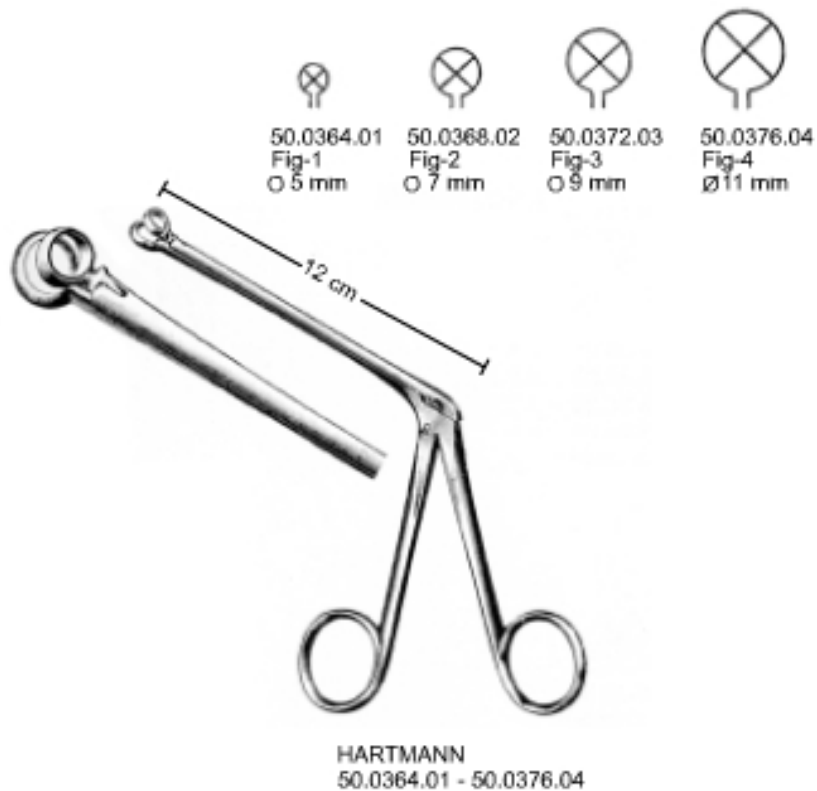
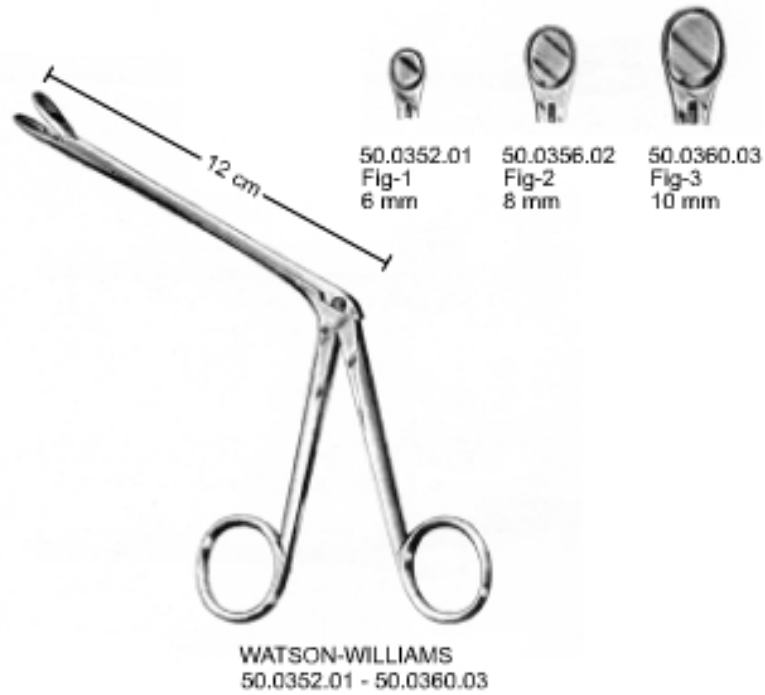

Fig-3



50

Nasal Polypus and Septum Compression Forceps
Polypenzangen, Septumzange
Pinzas Para Nasal Polypos, pinzas para el Tabique Nasal



Septum Compression Forceps
Pinzas Septumzange
Para el Tabique Nasal



WEIL-BLAKESLEY
50.0380.01 - 50.0392.04

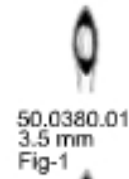

50.0380.01
3.5 mm
Fig-1



50.0384.02
4 mm
Fig-2



50.0388.03
4.5 mm
Fig-3



50.0392.04
5.5 mm
Fig-4

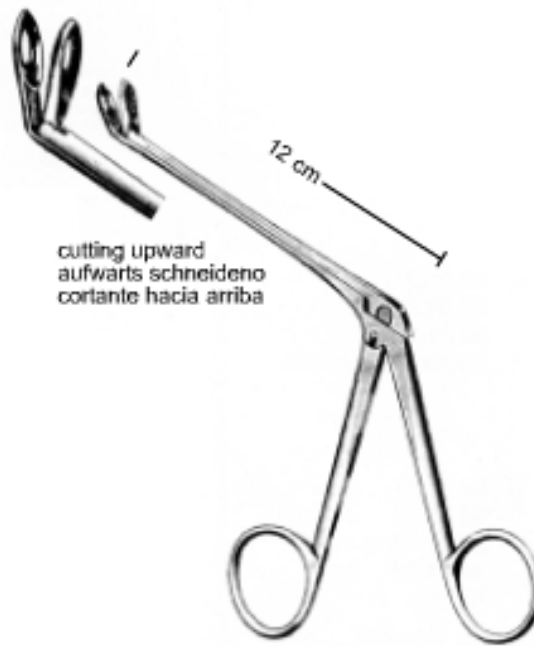

WEIL-BLAKESLEY
50.0396.01 - 50.0408.04



50.0396.01
3.5 mm
Fig-1



50.0400.02
4 mm
Fig-2



50.0404.03
4.5 mm
Fig-3



50.0408.04
5.5 mm
Fig-4

50

Nasal Polypus and Septum Compression Forceps
 Polypenzangen, Septumzange
 Pinzas para Nasal Polypos, Pinzas para el Tabique Nasal



SCHMEDEN
50.0412.01 - 50.0420.03

HARTMANN
50.0424.18
18 cm



HARTMANN
50.0428.20
20 cm



LITTAUER
50.0432.17
17 cm

Nasal Polypus and Septum Compression Forceps
 Polypenzangen, Septumzange
 Pinzas Para Nasal Polypos, Pinzas para el Tabique Nasal



TAKAHASHI
 50.0436.00 - 50.0440.00



WESTMACOT
 50.0444.20
 20 cm

WESTMACOT
 50.0448.20
 20 cm
 fine model
 feine modell
 finos modelo



LUBET-BARBON
 50.0452.20
 20 cm

50

Nasal Cutting Forceps
Scharfe Nasenzangen
Pinzas Cortantes para la Nartz

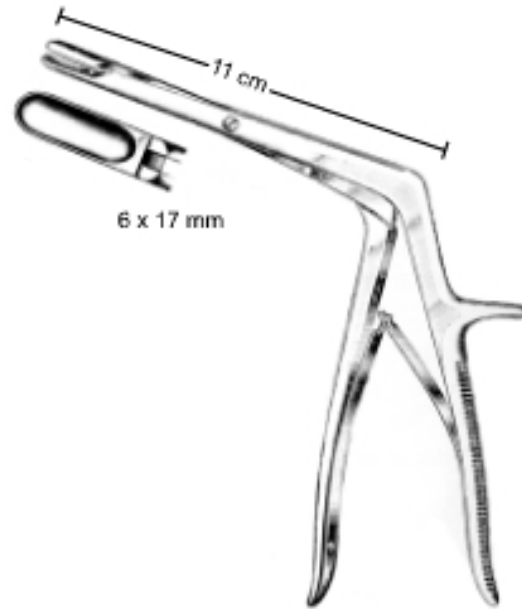

KOFLER
50.0456.00



JANSEN-MIDDLETON
50.0460.19
19 cm



JANSEN-MIDDLETON
50.0464.19
19 cm

Nasal Polypus and Septum Compression Forceps
Polypenzangen, Septumzange
Pinzas Para Nasal Polypos

50



TILLEY
50.0468.17
17 cm



NOYES
50.0472.00



NOYES
50.0476.00
1 x 2 teeth - zahne - dientes

50

Nasal Cutting Forceps
Scharfe Nasenzangen
Pinzas Cortantes para la Nartz



BLAKESLEY
(Lewis)
50.0480.00 - 50.0488.00



50.0480.00
9 mm



50.0484.00
9 mm



50.0488.00
9 mm

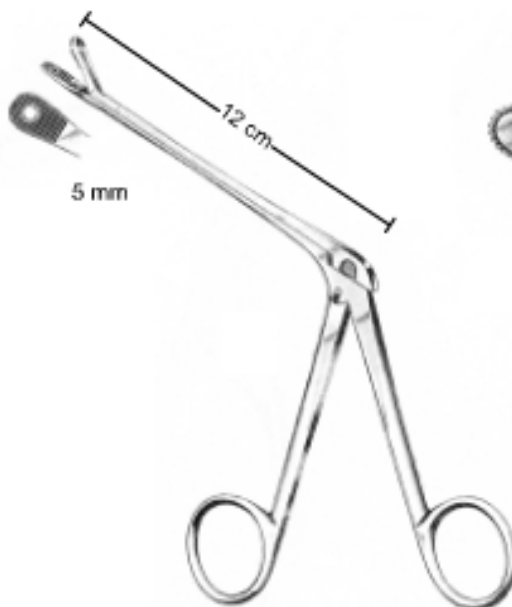

FERRIS-SMITH
50.0492.00



BLAKESLEY
50.0496.00

50

Nasal Polypus and Septum Compression Forceps
 Polypenzangen, Septumzange
 Pinzas Para Nasal Polypos

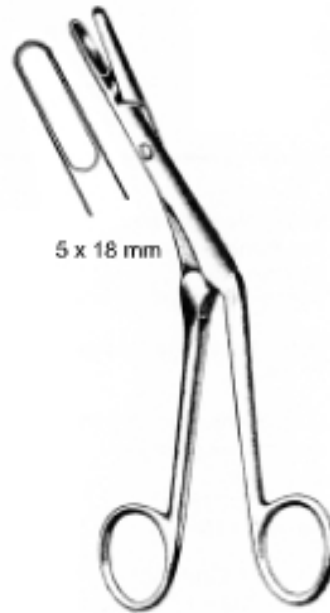

5 x 18 mm

CRAIG
 50.0524.17
 17 cm



50.0527.17
 7 x 18 mm
 curved to right
 nach rechts gebogen
 curva hacia derecha



50.0531.17
 7 x 18 mm
 curved to left
 nach links gebogen
 curva hacia izquierda

CRAIG-DOMNICK
 50.0527.17 - 50.0531.17
 17 cm

50

Nasal Polypus and Septum Compression Forceps
 Polypenzangen, Septumzange
 Pinzas Para Nasal Polypos

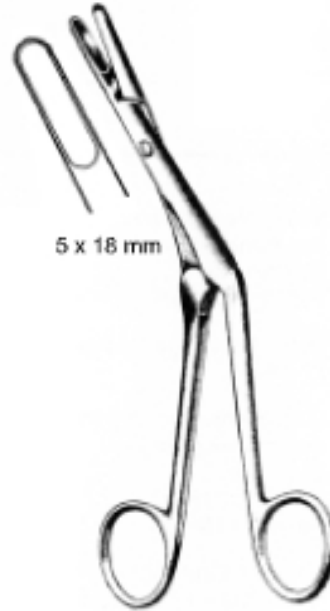

5 x 18 mm

CRAIG
 50.0524.17
 17 cm



50.0527.17
 7 x 18 mm
 curved to right
 nach rechts gebogen
 curva hacia derecha



50.0531.17
 7 x 18 mm
 curved to left
 nach links gebogen
 curva hacia izquierda

CRAIG-DOMNICK
 50.0527.17 - 50.0531.17
 17 cm

Septum Compression Forceps
 Septumzange
 pinzas Para el Tabique Nasal

50

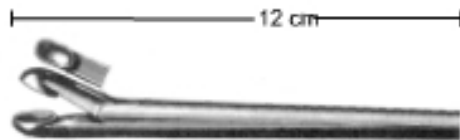

WATSON-WILLIAMS
 50.0538.00
 3 x 6 mm
 straight - gerade - recto

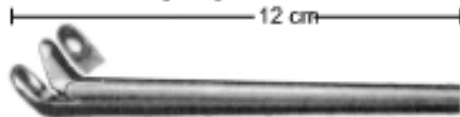

WATSON-WILLIAMS
 50.0542.00
 3 x 5 mm
 upward - aufwärts - hacia arriba

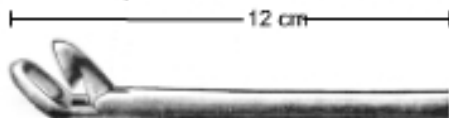

50.0546.01 50.0550.02 50.0554.03
 3.5 x 5 mm 4 x 6 mm 4.5 x 7 mm
 Fig-1 Fig-2 Fig-3

GRUENWALD
 upward - aufwärts - hacia arriba

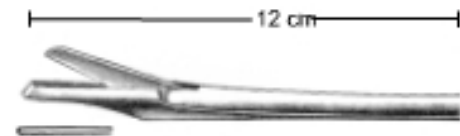

STRUYCKEN
 50.0558.00

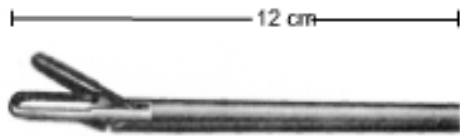

HENKE
 50.0562.00
 3 x 11 mm



50.0566.01 50.0570.02 50.0574.03
 3 x 12 mm 3.5 x 14 mm 4 x 15 mm
 Fig-1 Fig-2 Fig-3

HAJEK-GRUENWALD

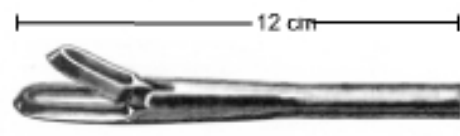

50.0578.01 50.0582.02 50.0586.03 50.0590.04
 2 x 10 mm 2.5 x 12 mm 3 x 14 mm 3.7 x 15 mm
 Fig-1 Fig-2 Fig-3 Fig-4

MYLES



COTTLE-WALSHAM
50.0594.01 - 50.0602.03
23 cm



50.0594.01
Fig-1



50.0598.02
Fig-2



50.0602.03
Fig-3



KAZANJIAN
50.0606.18
18 cm



MIDDELDORPF
48.0134.21
48.0142.22
48.0150.23



48.0134.21 21.5 cm
48.0138.21 21.5 cm
14 x 17 mm



48.0142.22 22 cm
48.0146.22 22 cm
20 x 22 mm



48.0150.23 23.5 cm
48.0154.23 23.5 cm
26 x 30 mm



MIDDELDORPF
48.0138.21
48.0146.22
48.0154.23
(17-040-00)



Mouth & Tongue

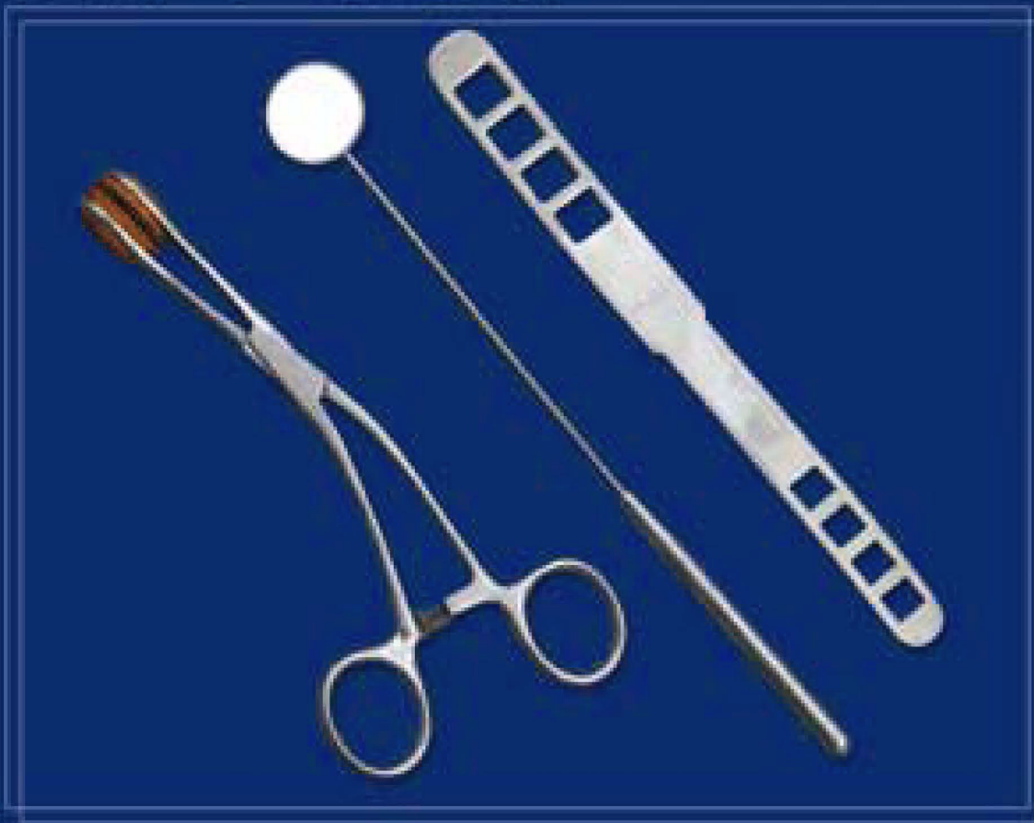



DAVIS - BOYLE
51.0102.10
10 cm
15.056.00



Fig-1
DAVIS - BOYLE
51.0106.01
27 x 105 mm
15.057.00



Fig-2
51.0110.02
25 x 90 mm



Fig-3
51.0114.03
25 x 75 mm



Fig-4
51.0118.04
22 x 60 mm



Fig-5
51.0122.05
20 x 25 mm

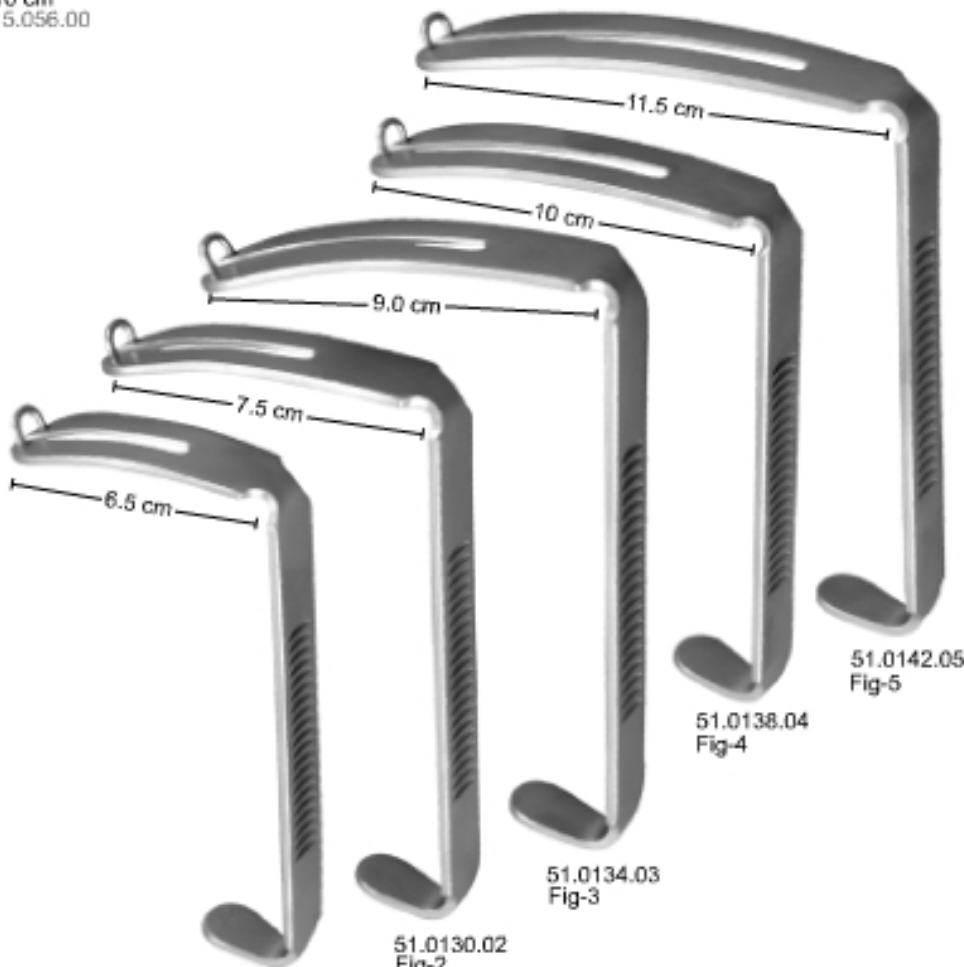

51.0126.01
Fin-1

51.0130.02
Fig-2

51.0134.03
Fig-3

51.0138.04
Fig-4

51.0142.05
Fig-5



DENHART
51.0146.12
12.5 cm



ROSER-KONIG
51.0150.18
18.5 cm



ROSER-KONIG
51.0154.16
16 cm



FERGUSSON-ACKLAND
51.0158.15
14.5 cm

51

Mouth Gags
Mundsperrer
Abre - Bocas



DOYEN-JANSEN
51.0162.14
14 cm



DOYEN-COLLIN
51.0166.12
12 cm



MOLT
51.0170.10
10 cm



HEISTER
51.0174.13
13 cm

Periosteal Raspatories
Raspatorien
Legras-Periostotomos



WILLIGER
51.0176.16
16.5 cm
(03.006.16)



WILLIGER
51.0178.17
17.5 cm
(03.005.17)

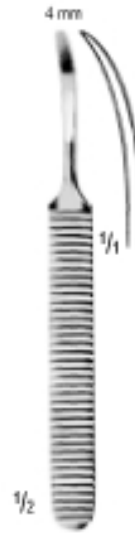

WILLIGER
51.0179.14
14 cm
(03.004.14)



WILLIGER
51.0181.16
16 cm
(03.007.16)

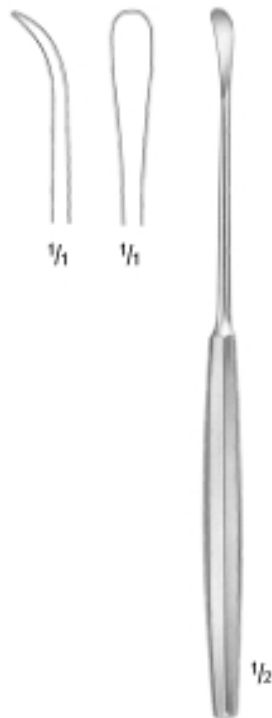

SEWAL
51.0183.20
20 cm

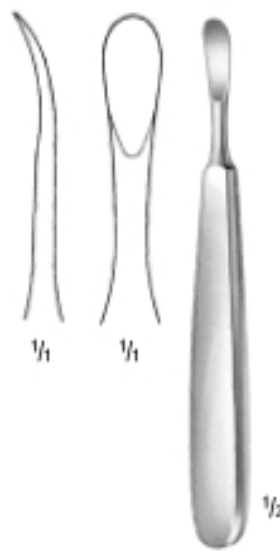

TRELAT
51.0185.15
15 cm

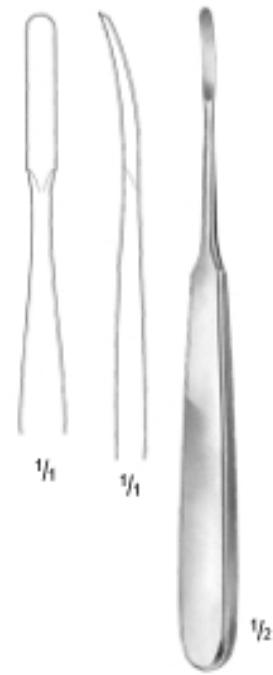

51.0187.18
18 cm

51

Tonsil Dessecting Scissors
Tonsillen Präparierschere
Tijera de diseccion de amigdalas

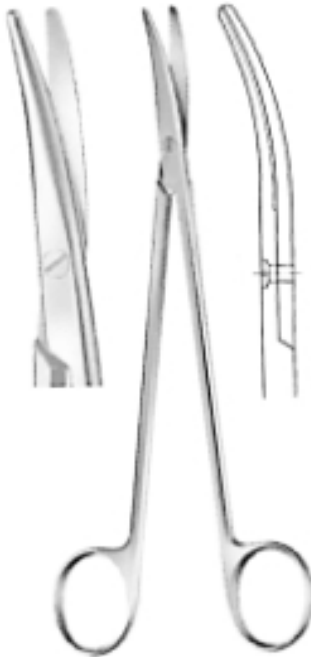

METZENBAUM
51.0178.18
18 cm

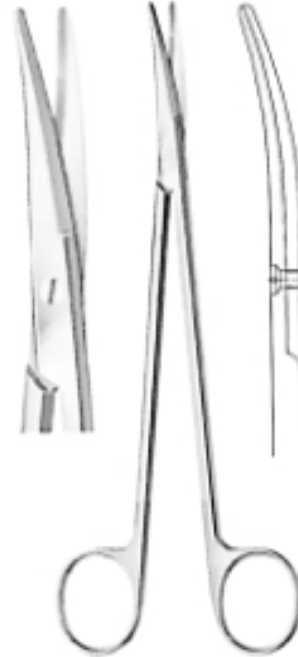

METZENBAUM
51.0181.18
18 cm

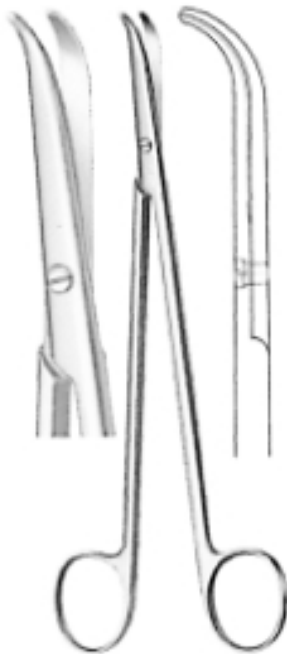

THOREK
51.0185.18
18 cm



BOETTCHER
51.0189.18
18 cm

Tonsil Dissecting Scissors
Tonsillen Präparierschere
Tijera de disección de amígdalas

51

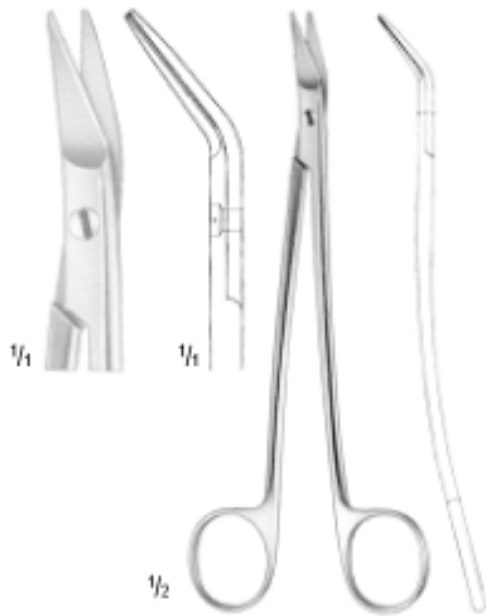

DEAN
51.0183.17
17 cm

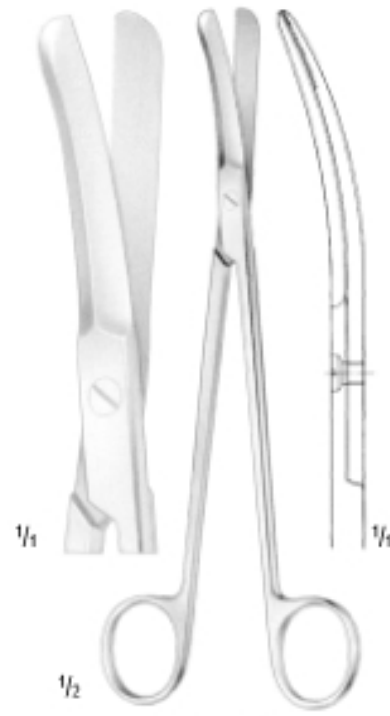

SCHWECKENDIEK
51.0185.18
19.5 cm

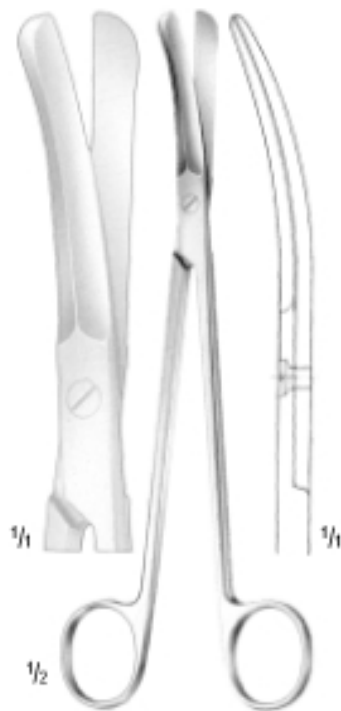

GOOD
51.0189.18
19.5 cm



PERWITSCHKY
51.0203.10
10 cm

51

Tonsil Dissectors & Retractors
Tonsillendissektor und retractors
Disectory retractor para amigdalas

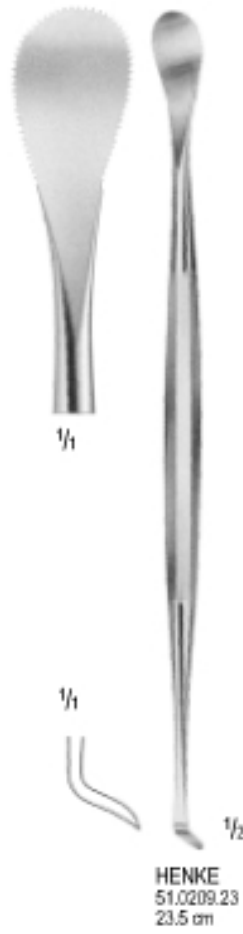
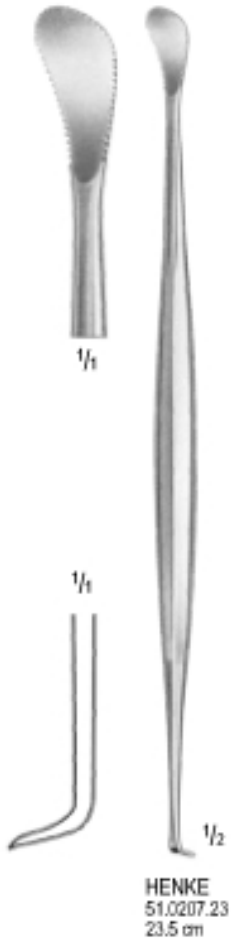

Tonsil Dessectors & Retractors
Tonsillendissektor und retractors
Disector y retractor para amígdalas

51



SYME
51.0225.18
18.5 cm



MOLLINSON
51.0229.21
21cm

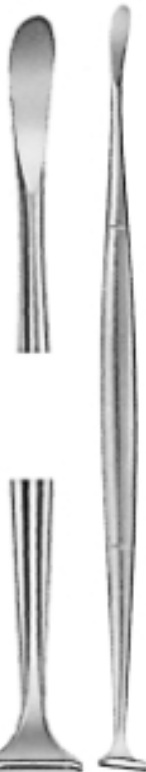

HURD
51.0233.21
21.5 cm



HURD
51.0237.21
21.5 cm

51

Tonsil Knife
Tonsillenmesser
Cuchillo para amígdalas



Tonsil Dissecting Forceps
Tonsillen Pinzette
Pinza de diseccion para amigdalas

51



WAUGH
51.0258.20
20 cm



WAUGH
51.0262.20
20 cm



MARSCHIK
51.0266.22
22 cm

51

Tonsil Dressing & Artery Forceps
Tonsillpolyzange-Tonsillenklemme
Pinza hemostatica para amigdalas



43.0729.19 43.0733.19

NEGUS
43.0729.19 - 43.0733.19
19 cm



MIKULICZ
51.0275.20
20 cm



DUPLAY
51.0279.21
21 cm

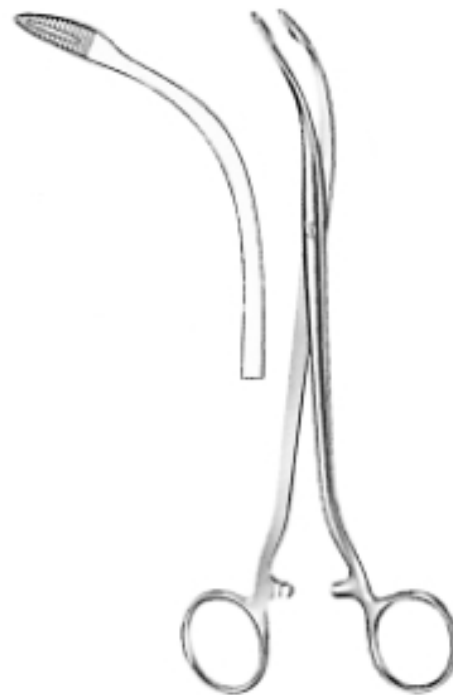

DUPLAY
51.0283.19
19 cm



LUCAS
51.0287.18
18 cm



LUCAS
51.0291.18
18.5 cm



MILLER
51.0295.18
18 cm

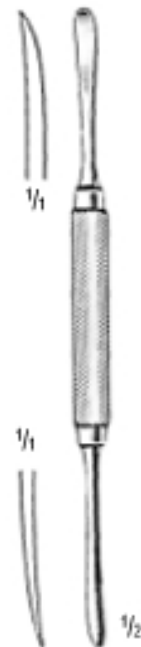

MOLT
51.0299.18
18 cm

51

Ligature Needles
Unterbindungsnadeln
Agujas para Ligadura

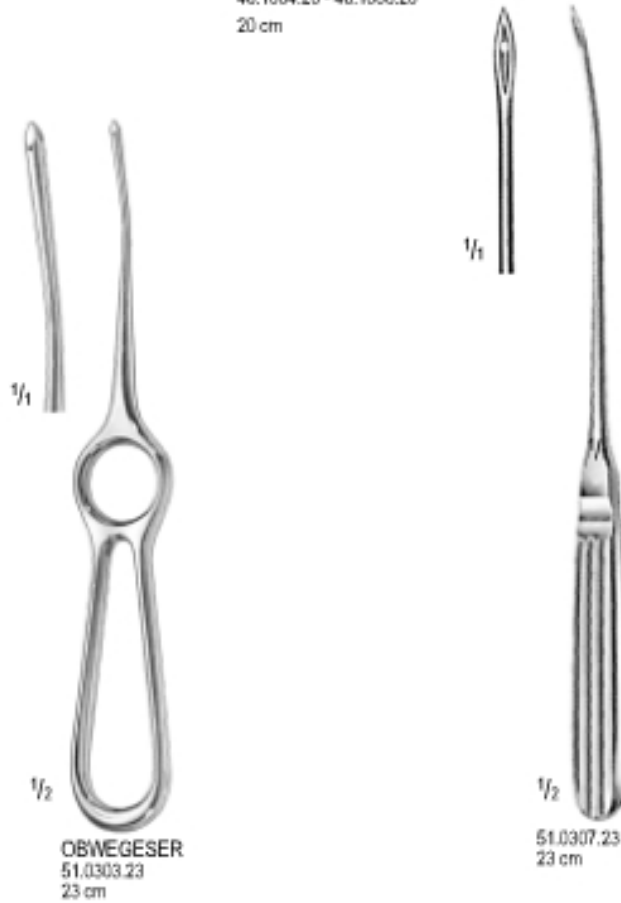

Adenoid Currettes
Rinamesser
Cuchillos para vegetaciones adenoides

51



50.0138.01



50.0142.02



50.0146.03



50.0154.04



50.0156.05



50.0158.06

BECKMANN
50.0138.01 - 50.0158.06
20 cm

51

Tonsil Artery Forceps
Tonsillenklemme
Pinza para amigdalas

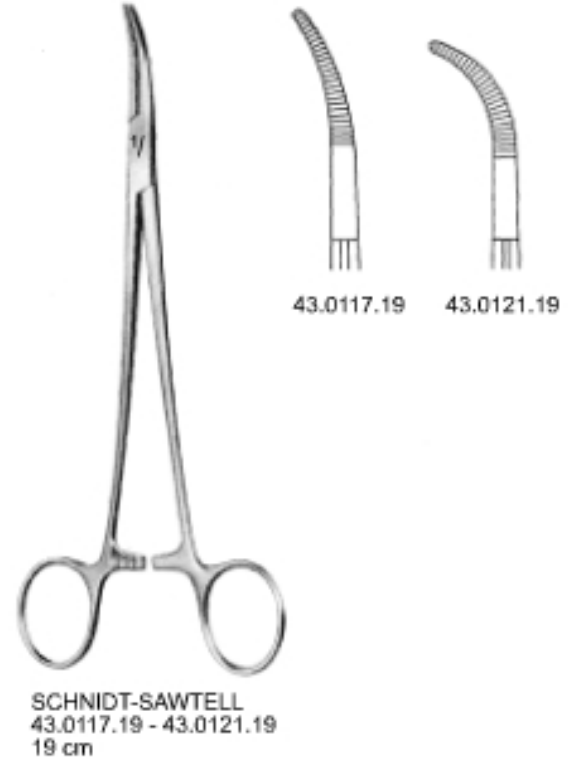
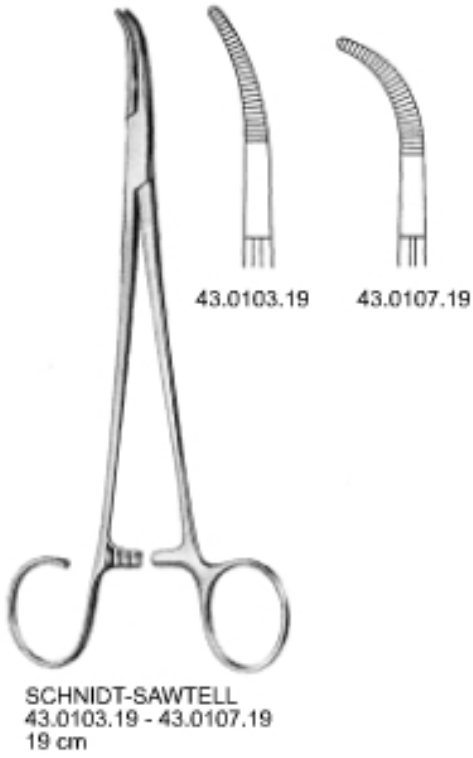

Adenoid and Tonsil Punchers
Conchotom und Tonsillen-Stanze
Pinza cortante para amígdalas

51

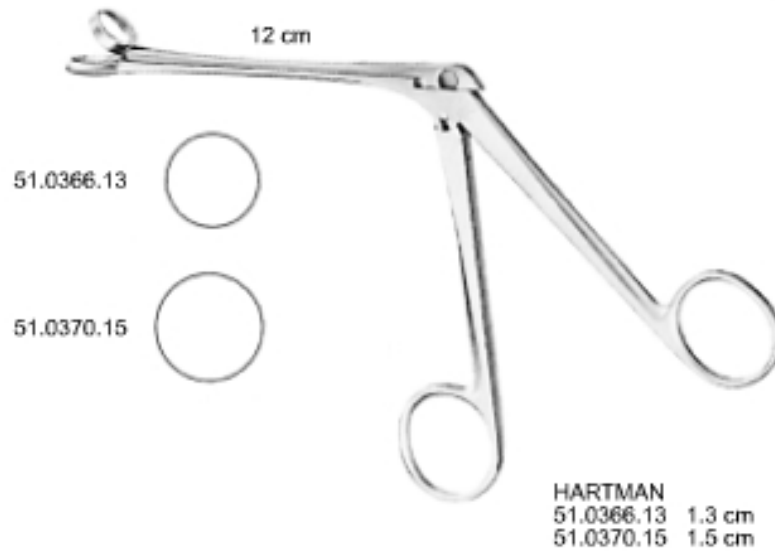
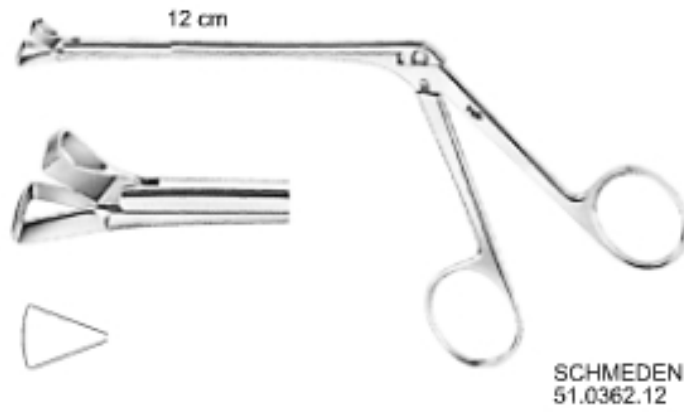

51

Tonsil Holding Forceps
Tonsillenfabzange
Pinza para sujetar amígdalas

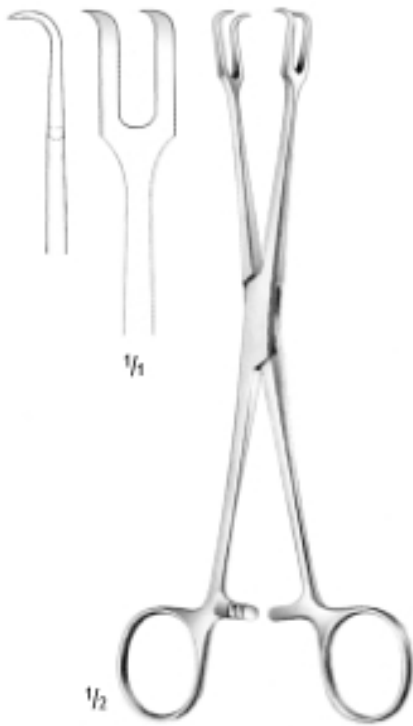

MUSEUX
51.0379.20
20 cm

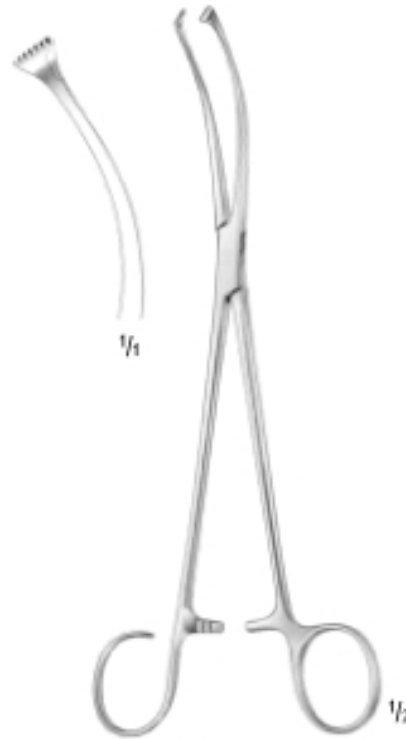

COLVER
51.0377.20
20 cm

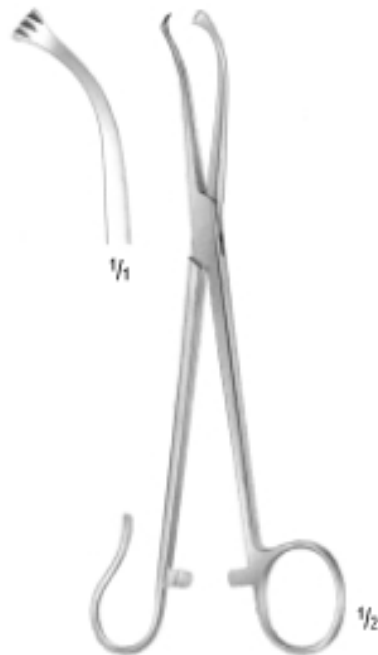

WHITE
51.0381.18
18 cm



WHITE
51.0387.23
23.5 cm

Tonsil Holding Forceps
Tonsillenfabzange
Pinza para sujetar amigdalas

51

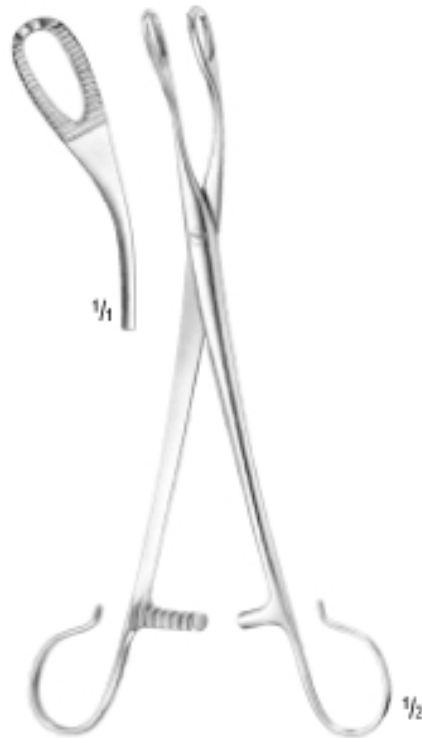

BLOHMKE
51.0391.20
20.5 cm



ABRAHAM
51.0395.20
20.5 cm

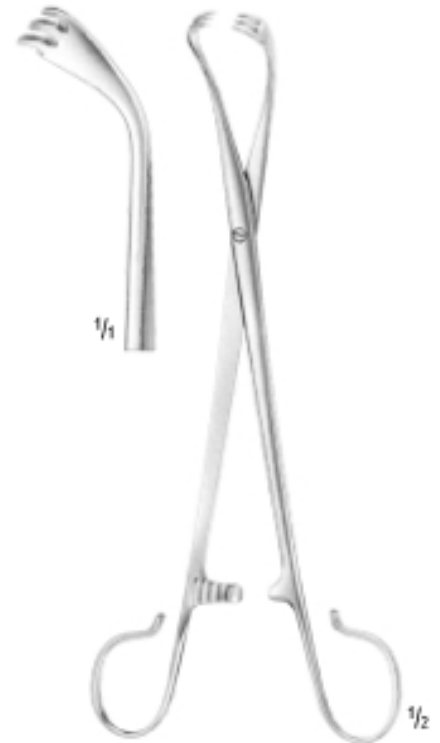

MARSCHIK-KRONE
51.0399.20
20.5 cm



McLVOR
51.0402.10
10 cm



51.0406.01
27 X 95 mm



51.0408.02
22 X 85 mm



51.0410.03
22 X 70 mm



JENNINGS
51.0414.09 9 cm
51.0418.11 11 cm
51.0422.13 13 cm
51.0426.15 15 cm



STEMBERG
51.0430.12 12 cm
51.0434.14 14 cm
51.0438.16 16 cm



STEMBERG
51.0442.14 14 cm
51.0446.16 16 cm
51.0450.18 18 cm

Tongue Holding Forceps,
Zungen Zangen
Pinzas Tira-Lengua

51



COLLIN
51.0454.16
16 cm



YOUNG
51.0458.17
17 cm

51

Tongue Depressors
Zungenspatel
Abaja - Lengua



BRUENINGS
51.0462.19
19 cm
(17.015.00)



BRUENINGS
51.0466.19
19 cm
(17.016.00)



MAYO
51.0472.17
17 cm



51.0476.01
Fig-1
14 cm



51.0480.02
Fig-2
15 cm



WIEDER
51.0476.01 - 51.0480.02



TOBOLD
51.0484.14
14.5 cm



PLESTER-R
48.1331.10 10 cm blunt-stumpf-romo
48.1333.13 13 cm blunt-stumpf-romo



PLESTER-L
48.1337.10 10 cm blunt-stumpf-romo
48.1341.13 13 cm blunt-stumpf-romo



ALM

- 48.0284.07 7.0 cm sharp-scharf-agudo
- 48.0285.07 7.0 cm blunt-stumpf-romo
- 48.0288.10 (17.007.10) 10 cm sharp-scharf-agudo
- 48.0289.10 (17.008.10) 10 cm blunt-stumpf-romo



FINSEN

- 48.0292.05 5.0 cm sharp-scharf-agudo
- 48.0293.05 5.0 cm blunt-stumpf-romo
- 48.0296.07 7.0 cm sharp-scharf-agudo
- 48.0297.07 7.0 cm blunt-stumpf-romo



ALLPORT

- 51.0520.09 9.5 cm sharp scharf agudo



51.0524.08	Fig-00 = 8 mm \varnothing	51.0572.08
51.0528.10	Fig-0 = 10 mm \varnothing	51.0576.10
51.0532.12	Fig-1 = 12 mm \varnothing	51.0580.12
51.0536.14	Fig-2 = 14 mm \varnothing	51.0584.14
51.0540.16	Fig-3 = 16 mm \varnothing	51.0588.16
51.0544.18	Fig-4 = 18 mm \varnothing	51.0592.18
51.0548.20	Fig-5 = 20 mm \varnothing	51.0596.20
51.0552.22	Fig-6 = 22 mm \varnothing	51.0600.22
51.0556.24	Fig-7 = 24 mm \varnothing	51.0604.24
51.0560.26	Fig-8 = 26 mm \varnothing	51.0608.26
51.0564.28	Fig-9 = 28 mm \varnothing	51.0612.28
51.0568.30	Fig-10 = 30 mm \varnothing	51.0616.30

YOUNG
51.0618.10
10 cm

FARRELL
(Lathbury-Uebe)
51.0620.12 12 cm
51.0624.14 14 cm
51.0626.16 16.5 cm

Tracheal Tubes, Dilators
 Tracheal - Kanülen, Dilatoren
 Canulas Traqueales, Diladores



standard pattern
 standard - Modell
 modelo standard

LUER
 51.0628.04 - 51.0688.13

Fig	mm \varnothing	Normal	Medium
		45 - 90 mm	95 mm
0	4	51.0628.04	
1	5	51.0632.05	
2	6	51.0636.06	
3	7	51.0640.07	
4	8	51.0644.08	51.0668.08
5	9	51.0648.09	51.0672.09
6	10	51.0652.10	51.0676.10
7	11	51.0656.11	51.0680.11
8	12	51.0660.12	51.0684.12
9	13	51.0664.13	51.0688.13



CHEVALIER - JACKSON
 51.0692.04-51.0728.13

Fig	mm \varnothing	Normal
		45 - 90 mm
0	4	51.0692.04
1	5	51.0696.05
2	6	51.0700.06
3	7	51.0704.07
4	8	51.0708.08
5	9	51.0712.09
6	10	51.0716.10
7	11	51.0720.11
8	12	51.0724.12
9	13	51.0728.13



LABORDE
 51.0732.14
 14 cm



TROUSSEAU
 51.0736.14
 14 cm

51

Polypus Snare
Polypenschnurer
Polopotos



KRAUSE
51.0740.16
16 cm



KRAUSE VOSS
51.0744.16
16 cm



EVES
Tonsil Snare
51.0748.25
25 cm



EVES
Tonsil Snare
51.0752.25
25 cm



Gynecology

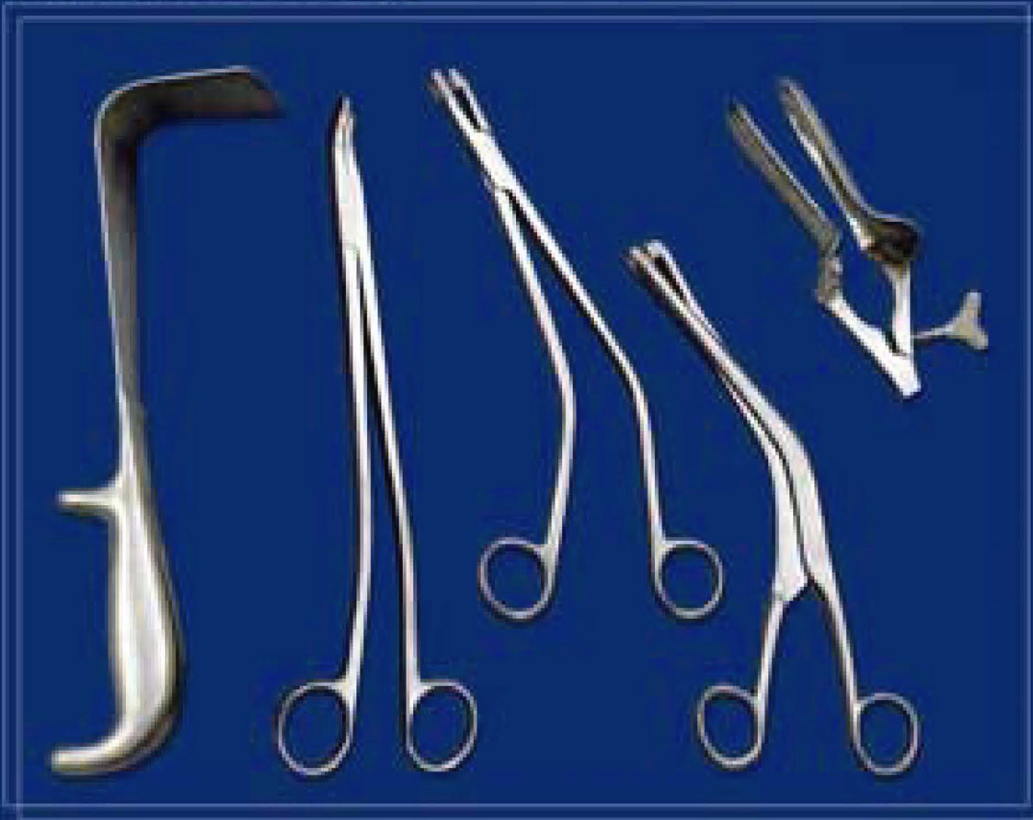

Vaginal Specula and Retractors
 Scheidenspekula und-Halter
 Especulos Y Valvas Vaginales



KALLMORGEN
 Vaginal Specula - Scheidenspekula - Especulos Vaginales
 52.0102.01 70 x 40 mm
 52.0106.02 90 x 40 mm



ALIVARD
 52.0108.24 105 x 38 mm
 24 cm



VAGINAL RETRACTOR
 52.0110.01 70 x 33 mm
 52.0114.02 90 x 33 mm



MATHIEU
 Specula - Spekula - Especulos
 52.0118.01 95 x 16 mm
 95 x 26 mm
 52.0122.02 95 x 16 mm
 95 x 30 mm



(RETRACTOR)
 52.0126.01 100 x 11 mm
 100 x 20 mm
 52.0130.02 100 x 14 mm
 100 x 26 mm



SIMS

52.0134.01	65 X 25 mm 70 x 30 mm
52.0138.02	70 x 30 mm 70 x 35 mm
52.0142.03	85 x 35 mm 90 x 40 mm



KRISTELLER

specula - spekula - especulos
52.0146.01 Fig-1 = 70 x 27 mm
52.0150.02 Fig-2 = 80 x 30 mm
52.0154.03 Fig-3 = 90 x 36 mm



KRISTELLER

retractors - halter - valvas
52.0158.01 Fig-1 = 75 x 23 mm
52.0162.02 Fig-2 = 85 x 26 mm
52.0166.03 Fig-3 = 100 x 32 mm



KRISTELLER

set of 1 speculum and 1 retractor each
satz aus je 1 spekulam und halter
juego de 1 especulo y 1 valva c/u
52.0170.01 Fig-1
52.0174.02 Fig-2
52.0178.03 Fig-3



KRISTELLER
specula - spekula - especulos
52.0182.01 Fig-1 = 105 x 18 mm
52.0186.02 Fig-2 = 105 x 21 mm



KRISTELLER
retractors - halter - valvas
52.0190.01 Fig-1 = 110 x 14 mm
52.0194.02 Fig-2 = 110 x 17 mm



KRISTELLER
set of 1 speculum and 1 retractor each
satz aus je 1 spekulam und halter
juego de 1 espejo y 1 valva c/u
52.0198.01 Fig-1
52.0202.02 Fig-2

Vaginal Specula and Retractors
Scheidenspekula und-Halter
Especulos Y Valvas Vaginales



KRISTELLER
specula - spekula - espejos
52.0206.01 Fig-1 = 105 x 26 mm
52.0210.02 Fig-2 = 105 x 28 mm
52.0214.03 Fig-3 = 105 x 33 mm



KRISTELLER
retractors - halter - valvas
52.0218.01 Fig-1 = 115 x 22 mm
52.0222.02 Fig-2 = 115 x 24 mm
52.0226.03 Fig-3 = 115 x 29 mm



KRISTELLER
Set of 1 Specula and 1 Retractor each
satz aus je 1 spekulum und halter
juego de 1 espejulo - y 1 valva c/u
52.0230.01 Fig-1
52.0234.02 Fig-2
52.0238.03 Fig-3

Vaginal Specula and Retractors
 Scheidenspekula und-Halter
 Especulos Y Valvas Vaginales



KRISTELLER
 Specula - spekula - especulos
 52.0242.01 Fig-1 = 110 x 27 mm
 52.0246.02 Fig-2 = 110 x 30 mm
 52.0250.03 Fig-3 = 110 x 36 mm



KRISTELLER
 retractor - halter - valvas
 52.0254.01 Fig-1 = 115 x 23 mm
 52.0258.02 Fig-2 = 115 x 26 mm
 52.0262.03 Fig-3 = 115 x 32 mm



KRISTELLER
 set of 1 specula and 1 retractor
 satz aus je 1 spekulam und halter
 juego de 1 especulo y 1 valvas c/u
 52.0266.01 - Fig - 1
 52.0270.02 - Fig - 2
 52.0274.03 - Fig - 3



PEDERSON
 52.0278.01 75 x 13 mm
 52.0282.02 100 x 22 mm
 52.0284.03 120 x 25 mm



SEMM
 52.0286.01 65 x 20 mm
 52.0288.02 90 x 16 mm



COLLIN
 52.0290.01 85 x 30 mm
 52.0294.02 100 x 35 mm
 52.0298.03 110 x 40 mm



COLLIN
 52.0302.01 100 x 17/20 mm
 52.0306.02 100 x 25/30 mm

Vaginal Specula
Scheidenspekula
Especulos Vaginales

52



GRAVE
52.0310.01 75 x 20 mm
52.0314.02 95 x 35 mm
52.0318.03 115 x 35 mm



CUSCO
52.0320.01 75 x 17 mm



CUSCO
52.0322.01 75 x 32 mm
52.0326.02 85 x 35 mm
52.0330.03 100 x 37 mm



CUSCO
52.0334.01
75 x 17 mm



CUSCO
52.0338.01 75 x 32 mm
52.0342.02 85 x 35 mm
52.0346.03 100 x 35 mm



CUSCO
52.0350.01 80 x 22 mm
52.0354.02 100 x 25 mm
52.0358.03 105 x 27 mm

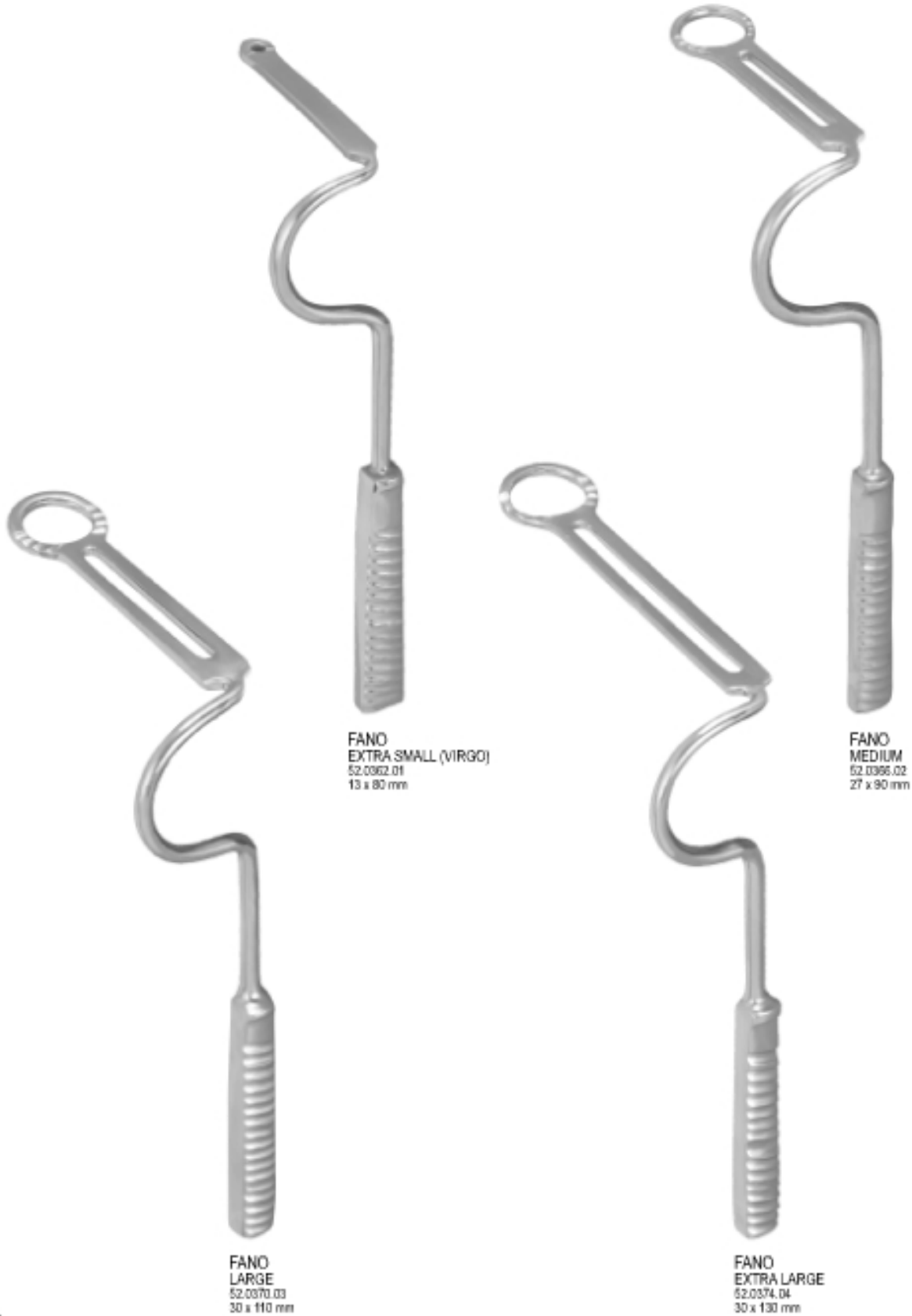



GENTOFTE
EXTRA SMALL (VIRGO)
52.0378.01
15 x 80 mm



GENTOFTE
SMALL
52.0382.02
27 x 105 mm



GENTOFTE
MEDIUM
52.0386.03
30 x 110 mm

52

Vaginal Specula
Scheidenspekula
Especulos Vaginales



GENTOFTE
LARGE
52.0380.04
32 x 120 mm



GENTOFTE
EXTRA LARGE
52.0384.05
32 x 140 mm

Vaginal Specula, Depressor
 Scheidenspekula, Depressoren
 Especulos Vaginales, Depresores

52



BREISKY

52.0398.01	16x20 mm
52.0402.02	24x28 mm
52.0406.03	32x35 mm
52.0410.04	40x44 mm



BRAUN

52.0414.15	15 mm 25cm 10"
52.0418.25	25 mm 25cm 10"



70 x 30 mm

DOYEN
52.0422.24
24 cm

DOYEN	
52.0426.01	55 x 35 mm
52.0430.02	58 x 35 mm
52.0434.03	115 x 35 mm
52.0438.01	55 x 45 mm
52.0442.02	85 x 45 mm
52.0446.03	115 x 45 mm
52.0448.04	160 x 45 mm
52.0450.01	55 x 60 mm
52.0454.02	85 x 60 mm
52.0458.03	115 x 60 mm
52.0462.04	160 x 60 mm

BREISKY	
52.0466.01	100 x 20 mm
52.0470.02	100 x 25 mm
52.0474.03	100 x 30 mm
52.0478.04	100 x 35 mm
52.0482.05	100 x 40 mm
52.0486.01	130 x 20 mm
52.0490.02	130 x 25 mm
52.0494.03	130 x 30 mm
52.0498.04	130 x 35 mm
52.0502.05	130 x 40 mm
52.0504.05	155 x 40 mm

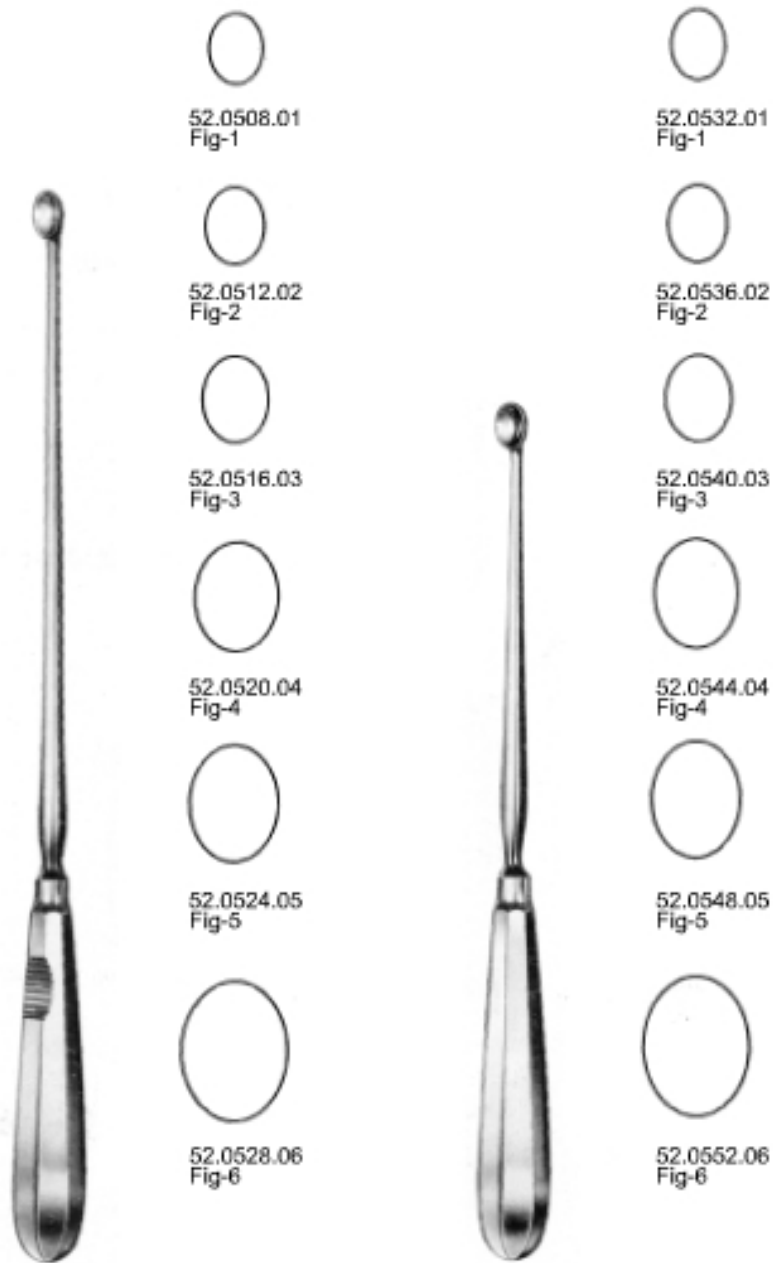

SCHROEDER
 52.0508.01 - 52.0528.06
 30 cm
 sharp
 scharf
 agudo

SIMON
 52.0532.01 - 52.0552.06
 25 cm
 sharp
 scharf
 agudo

52

Uterine Curettes
Uteruskurettten
Curetas Uterinas

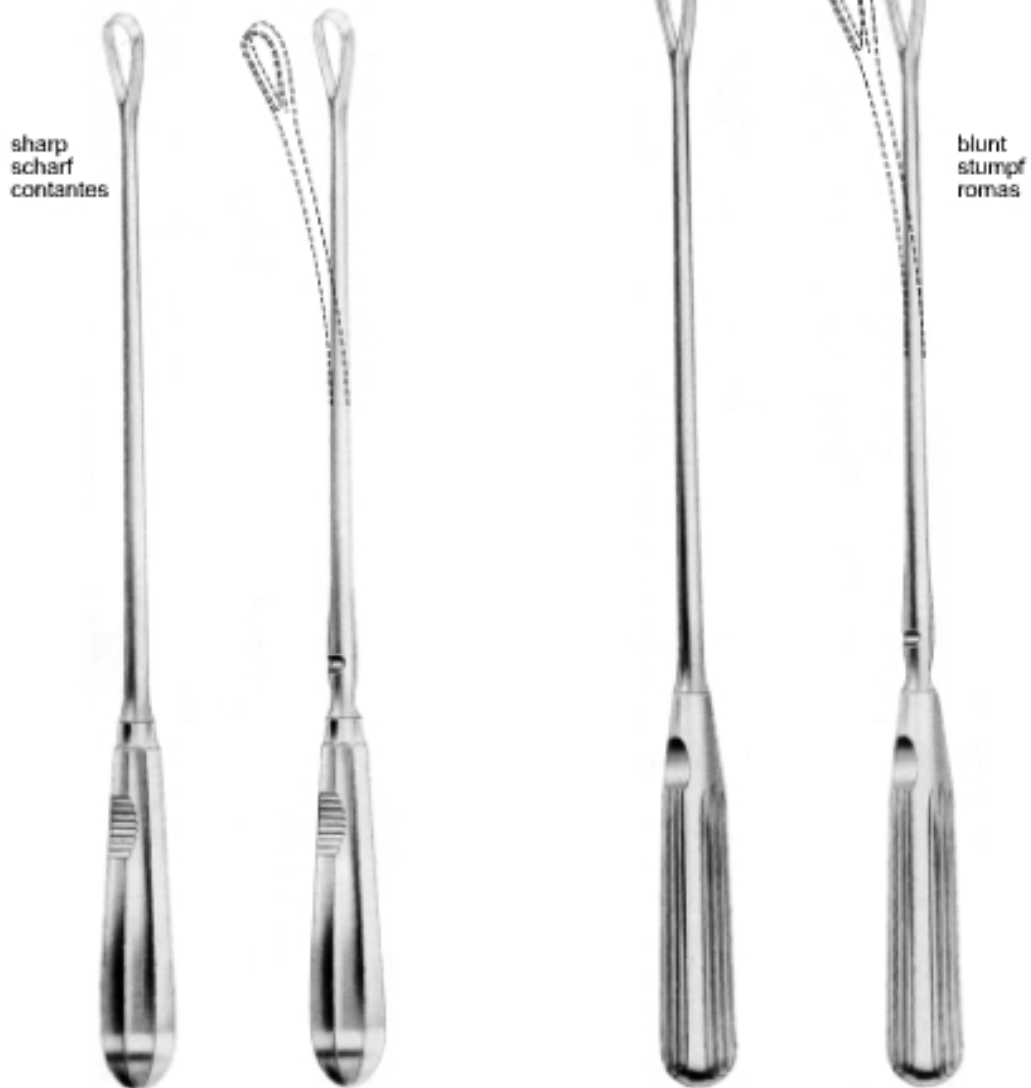

sharp
scharf
contantes

blunt
stumpf
romas

RECAMIER - SIMS - BUMM
Rigid
Fest
Rigidos
52.0556.31
31 cm

Malleable
Biegsam
Maleables
52.0560.31
31 cm

RECAMIER - SIMS - BUMM
Rigid
Fest
Rigidos
52.0564.31
31 cm

Malleable
Biegsam
Maleables
52.0568.31
31 cm

Uterine Curettes
 Uteruskurettten
 Curetas Uterinas

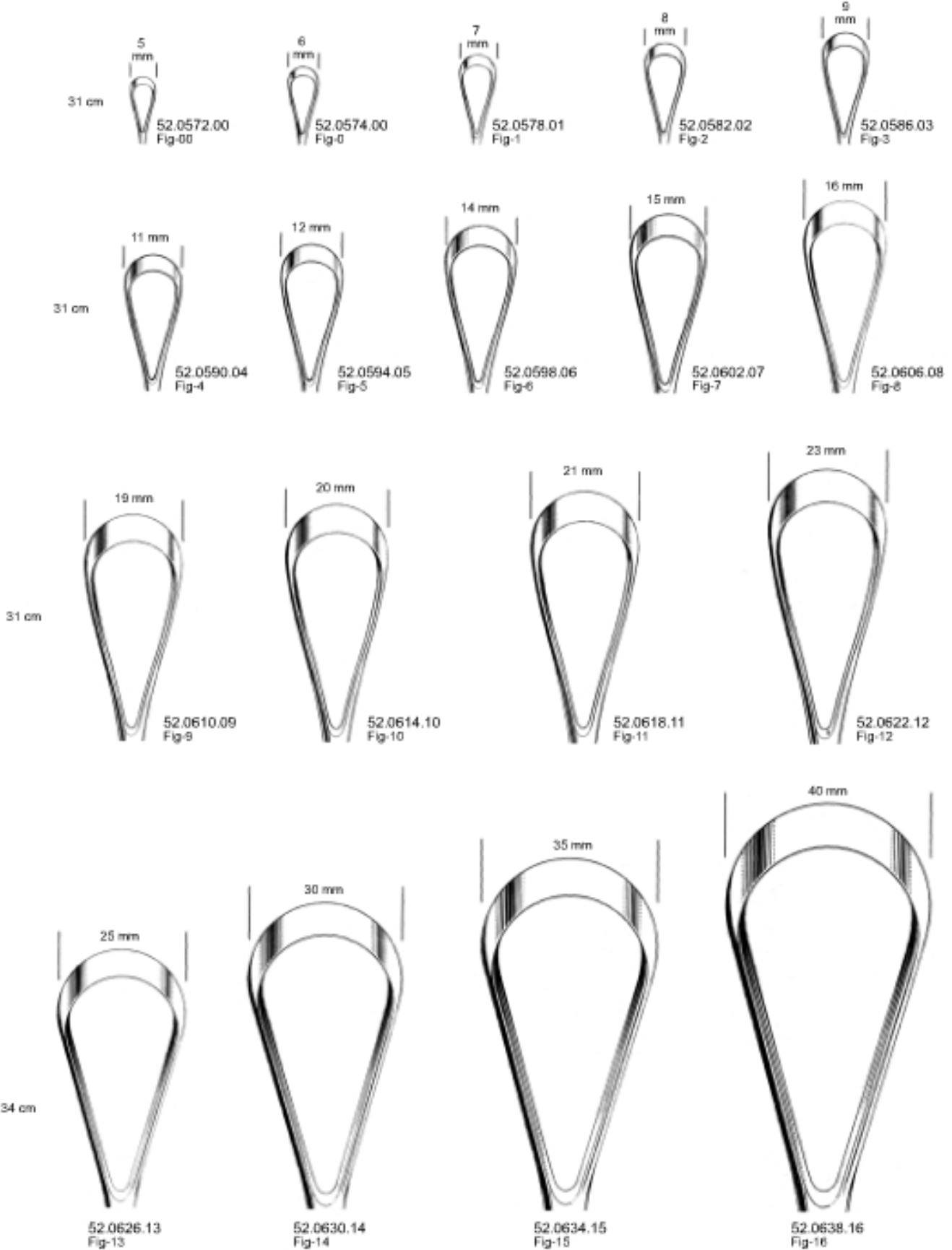

52

Cervical Biopsy and Specimen Forceps
 Probeexzisionzangen
 Pinzas Saca, Bocados Para Biopsia

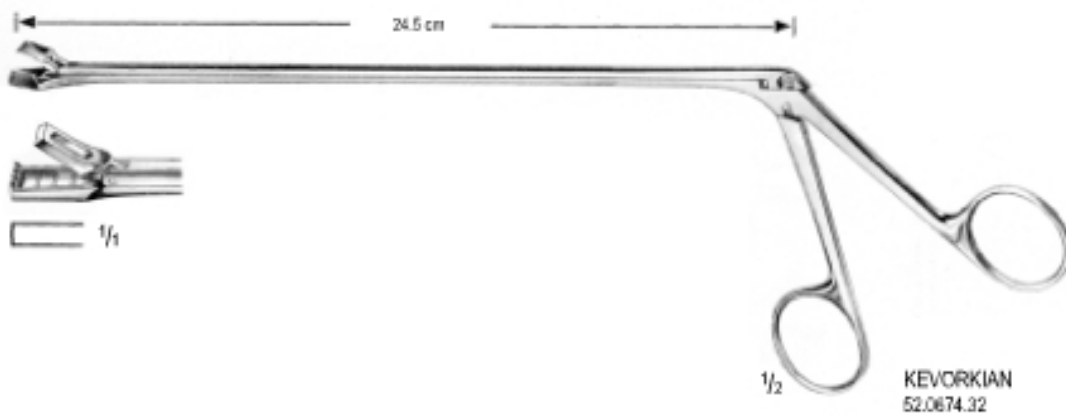
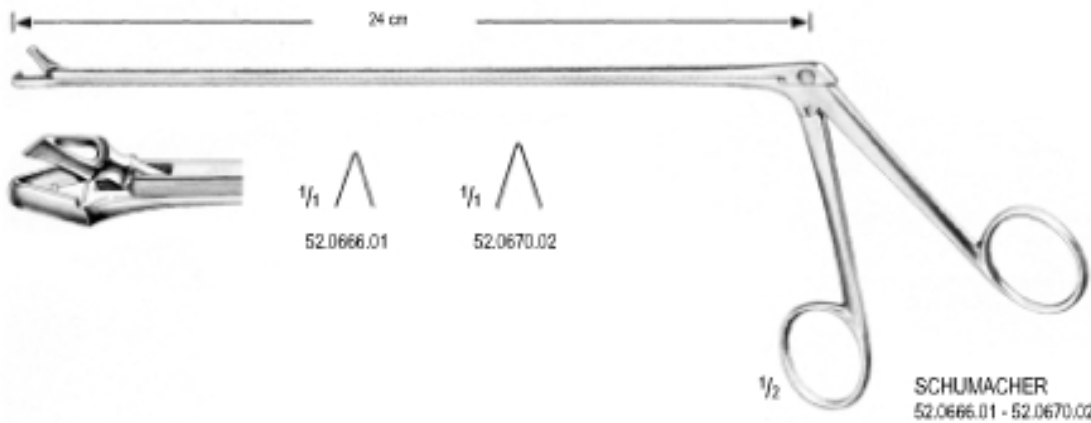

Cervical Biopsy and Specimen Forceps
 Probeexszionzangen
 Pinzas Saca, Bocados Para Biopsia

52



VAN DOREN
 52.0679.24
 24 cm



VAN DOREN
 52.0683.25
 25 cm



FAURE
 52.0687.21
 21 cm

52

Cervical Biopsy and Specimen Forceps
Probeexzszionzangen
Pinzas Saca, Bocados Para Biopsia



THOMS-GAYLOR
52.0691.2222 cm
52.0695.2424 cm



THOMAS-GAYLOR
52.0699.24
24 cm



GELLHORN
52.0703.23
23 cm

Cervical Biopsy and Specimen Forceps
Probeexszionzangen
Pinzas Saca, Bocados Para Biopsia

52



SCHUBERT
52.0706.21 22 cm
52.0710.29 29 cm



SCHUBERT
52.0715.26
26 cm

52

Tenaculum Forceps
Hakenzangen
Pinzas Para Coger el Cuello del Utero



BEACHAM
52.0718.26
26 cm

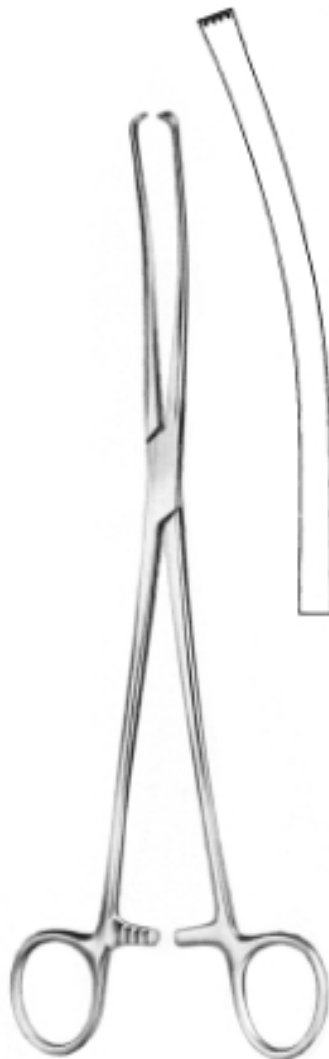

LOWA
52.0721.26
26 cm



SKENE
52.0725.24
24 cm



STAUDE-MOORE
52.0729.17
17 cm

Tenaculum Forceps
Hakenzangen
Pinzas Para Coger el Cuello del Utero

52



BRAUN
52.0734.25
25 cm



DUPLAY
52.0739.28
28 cm

52

Tenaculum Forceps
Hakenzangen
Pinzas Para Coger el Cuello del Utero



SCHROEDER
52.0744.25
25 cm



MUSEUX
52.0748.24 - 52.0756.24
24 cm



6 mm

52.0748.24



8 mm

52.0752.24



10 mm

52.0756.24



TEALE
52.0761.23
23 cm

Tenaculum Forceps
Hakenzangen
Pinzas Para Coger el Cuello del Utero

52



POZZI
52.0764.25
25 cm

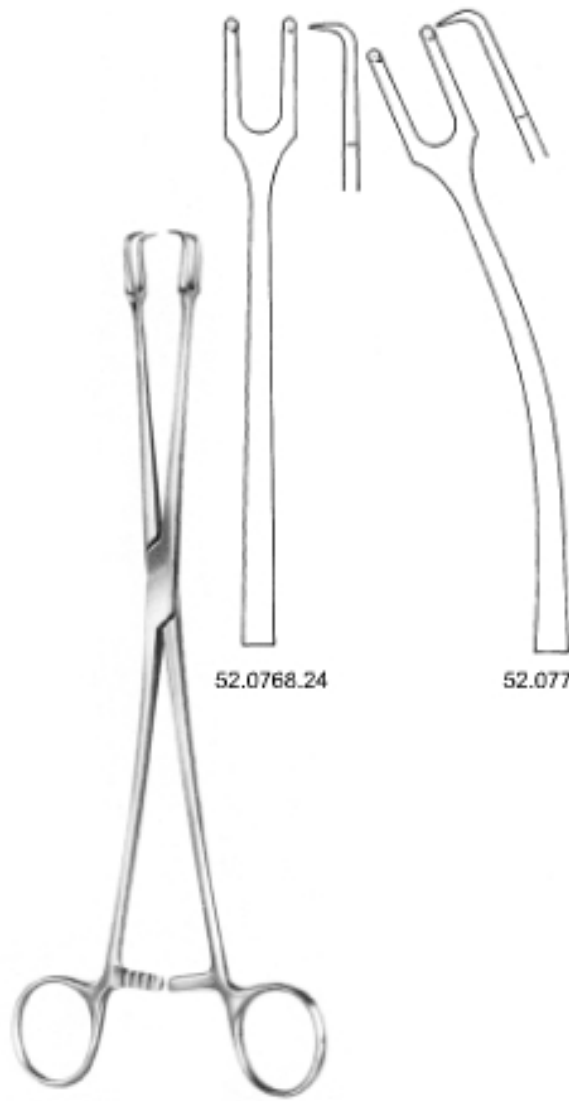

SCHROEDER
52.0768.24 - 52.0771.24
24 cm

52

Tenaculum Forceps
Hakenzangen
Pinzas Para Coger el Cuello del Utero



BRAUN
52.0776.16
15.5 cm



CZERNY
52.0780.20
20 cm



52.0784.26
26 cm



JACOBS
52.0788.21
21 cm

▶ 400

Uterine Polypus Forceps
Uterus Polypenzangen
Pinza Para Polipos Uterinos

52



DOYEN
52.0792.20
20 cm

NOTO
52.0796.27
27 cm

KELLY
52.0801.32
32 cm



KOGAN
52.0805.24
24 cm
without ratchet
ohne sperre
sin cremallera



KOGAN
52.0809.24
24 cm
with scale-ratchet and fixing screws
mit skalensperre und fixierschraube
concremallera graduada y tornillos fijadores

Suction Biopsy Currettes
 Saug und Biopsiekurretten
 Curretas Aspiradoras Para Biosia



KEVORKIAN
 52.0813.30
 30 cm



NOVAK
 52.0817.23
 23 cm



MOD-MUENCHEN
 52.0821.27
 27 cm

Fistula Hooks, Cone Knife
 Fistelhaken, Honusmesser
 Ganchos p. Fistulas,
 Bisturi p. Conos de Atraccion



SIMON
 52.0826.22
 22 cm



SIMON
 52.0830.22
 22 cm

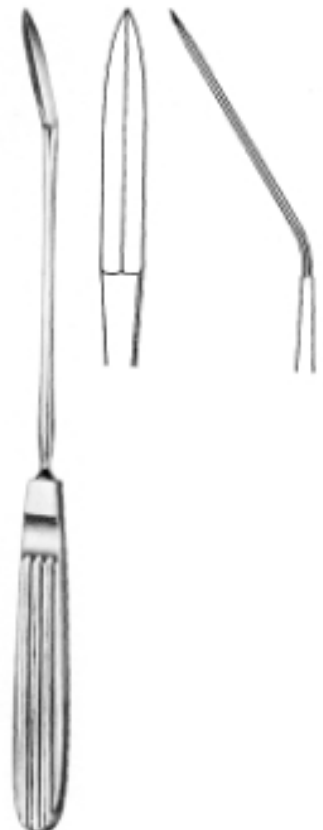

AYRE
 52.0835.23
 23 cm



malleable
biegsam
maleable

SIMS
52.0839.32
32 cm



malleable
biegsam
maleable

MARTIN
52.0843.32
32 cm



VALLEIX
52.0847.25
25 cm



BRAUN
52.0851.28
28 cm

Uterine Dilators
 Uterus-Dilatatoren
 Dilatadores Uterinos

52



HANK
 52.0856.00
 set 6 of pieces in canvas roll
 satz zu 6 stück in stoff-rolltasche
 juego de 6 piezas en bolsa de tela



HANK
 52.0860.10 - 52.0880.20

America scale
 amerikanische skala
 escala americana
HANK

fig 9/10	52.0860.10	= 4.5/5 mm
fig 11/12	52.0864.12	= 5.5/6 mm
fig 13/14	52.0868.14	= 6.5/7 mm
fig 15/16	52.0872.16	= 7.5/8 mm
fig 17/18	52.0876.18	= 8.5/9 mm
fig 19/20	52.0880.20	= 9.5/10 mm



HEGAR

mmØ	
1.0	52.0884.01
1.5	52.0885.01
2.0	52.0888.02
2.5	52.0889.02
3.0	52.0892.03
3.5	52.0893.03
4.0	52.0896.04
4.5	52.0897.04
5.0	52.0900.05
5.5	52.0901.05
6.0	52.0904.06
6.5	52.0905.06
7.0	52.0908.07
7.5	52.0909.07
8.0	52.0912.08
8.	52.0913.08
9.0	52.0916.09
9.5	52.0917.09
10.0	52.0920.10
10.5	52.0921.10
11.0	52.0924.11
11.5	52.0925.11
12.0	52.0928.12
12.5	52.0929.12
13.0	52.0932.13
13.5	52.0933.13
14.0	52.0936.14
14.5	52.0937.14
15.0	52.0940.15
15.5	52.0941.15
16.0	52.0944.16
16.5	52.0945.16
17.0	52.0948.17
17.5	52.0949.17
18.0	52.0952.18
18.5	52.0953.18
19.0	52.0956.19
19.5	52.0957.19
20.0	52.0960.20
21.0	52.0964.21
22.0	52.0968.22
23.0	52.0972.23
24.0	52.0976.24
25.0	52.0980.25
26.0	52.0984.26

mm O

1.0/2.0	52.0988.02
3.0/4.0	52.0992.04
5.0/6.0	52.0996.06
7.0/8.0	52.1000.08
9.0/10.0	52.1004.10
11.0/12.0	52.1008.12
13.0/14.0	52.1012.14
15.0/16.0	52.1016.16
17.0/18.0	52.1020.18
19.0/20.0	52.1024.20
21.0/22.0	52.1028.22
23.0/24.0	52.1032.24
25.0/26.0	52.1036.26

Uterine Dilators
Uterus-Dilatatoren
Dilatadores Uterinos

52



52.1040.00 Set of 8 dilators 3.0/4.0 - 17.0/18.0 mm ♂
Satz zu 8 dilatatoren 3.0/4.0 - 17.0/18.0 mm ♂
Juego de 8 dilatadores 3.0/4.0 - 17.0/18.0 mm ♂

52

Uterine Elevating Forceps, Uterus-fabzangen, Pinzas Para el Utero, Myoma Instruments, Myom-Instrumente, Instrumentos Para Fibroma, Cervical Biopsy and Specimen Forceps, Probeexzisionszangen, Pinzas Saca-Bocados Para Biopsia



1/2 SOMMER
52.1104.23
23 cm



1/2 DARTIGUES
52.1108.27
27 cm



DARTIGUES
52.1110.27
27 cm



1/2 DOYEN
52.1112.17
17 cm



3 x 6.5 mm



TISCHLER-KEVORKIAN
52.1116.00
17 cm

▶ 407 A



Obstetrics

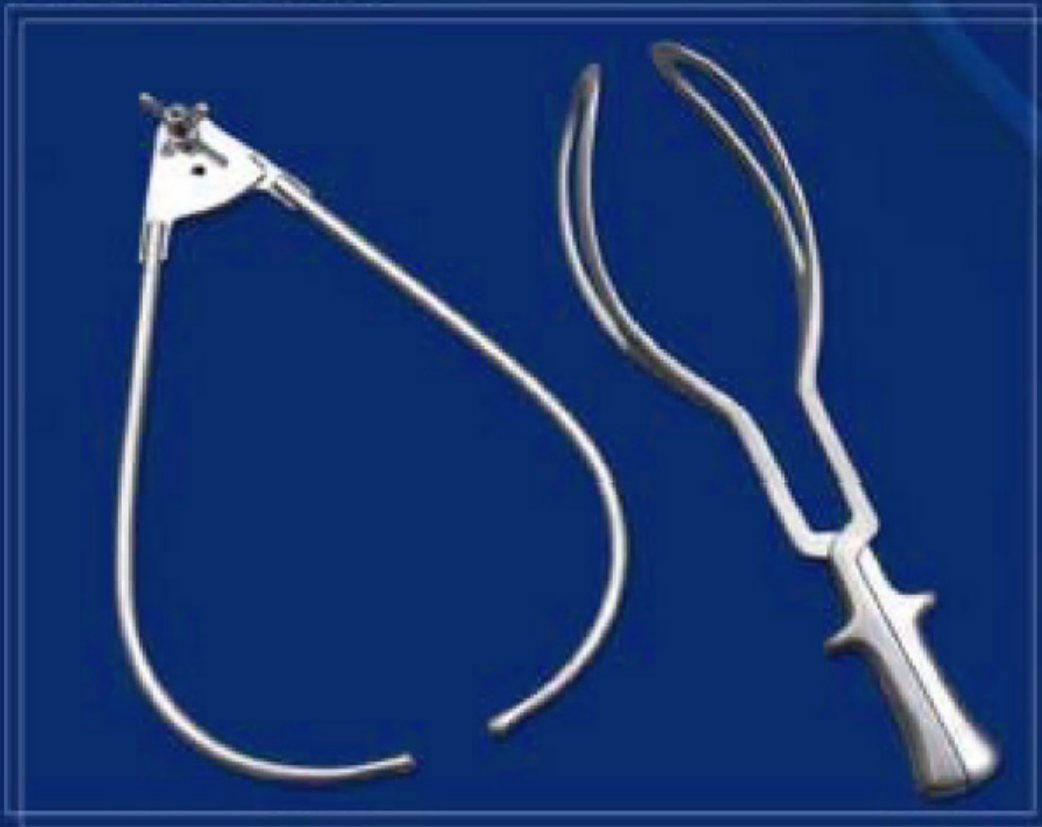



SIMPSON
53.0102.30
30 cm



SIMPSON-BRAUN
53.0106.36
36 cm



NAEGELE
53.0110.36 36 cm
53.0114.40 40 cm



MARTIN
53.0118.34
34 cm



KIELLAND
53.0122.41
41 cm

53

Obstetrical Forceps
Geburtszangen
Forceps Obstetricos



De Lee
53-0124-30
30 cm



De Lee
53-0126-36 36 cm
53-0128-39 39 cm



ELLIOT
53-0127-32 32 cm
53-0129-38 38 cm



Mc LEAN
53.0131.36
36 cm



KIELLAND-LUIKART
53.0133.36
40 cm



PIPER
53.0135.36
44 cm

53

Ovum Currettes, Abortion Scoops, Umbilical Cord Clamps
Abortuskuretten und-loffel, Nabelschnurklemmen
Curetas Y Cucharillas Para Aborto, Clamps Umbilicales



KANE
53.0137.08
8.5 cm



COLLIN
53.0138.09
9 cm



PESTALOZZA
53.0140.30
30 cm



toothed back
ruckseite gezahnt
con dorso dentado

GUZZI
53.0141.30 - 53.0147.30
30 cm



14.5 mm
53.0141.30



18 mm
53.0143.30



21 mm
53.0147.30

blunt - stumpf -
romas

Scalp Flap Forceps, Elevating Spoon etc.
 Kopfschwartenzangen, Geburtsloffel usw
 Pinzas Para Pericraneio, separador Para la Salida de Cabeza



GREEN-ARMYTAGE
 53.0150.21
 21 cm



SMELLIE
 53.0152.25
 25 cm



SAENGER
 53.0154.27 - 53.0155.27
 27 cm

53.0154.27
 straight
 gerade
 rectas

53.0155.27
 curved
 gebogen
 curvas



WINTER
 53.0158.28 - 53.0163.28
 28 cm

53.0158.28
 straight
 gerade
 rectas

53.0159.28
 curved
 gebogen
 curvas

53.0162.28
 straight
 gerade
 rectas

53.0163.28
 curved
 gebogen
 curvas



Probes

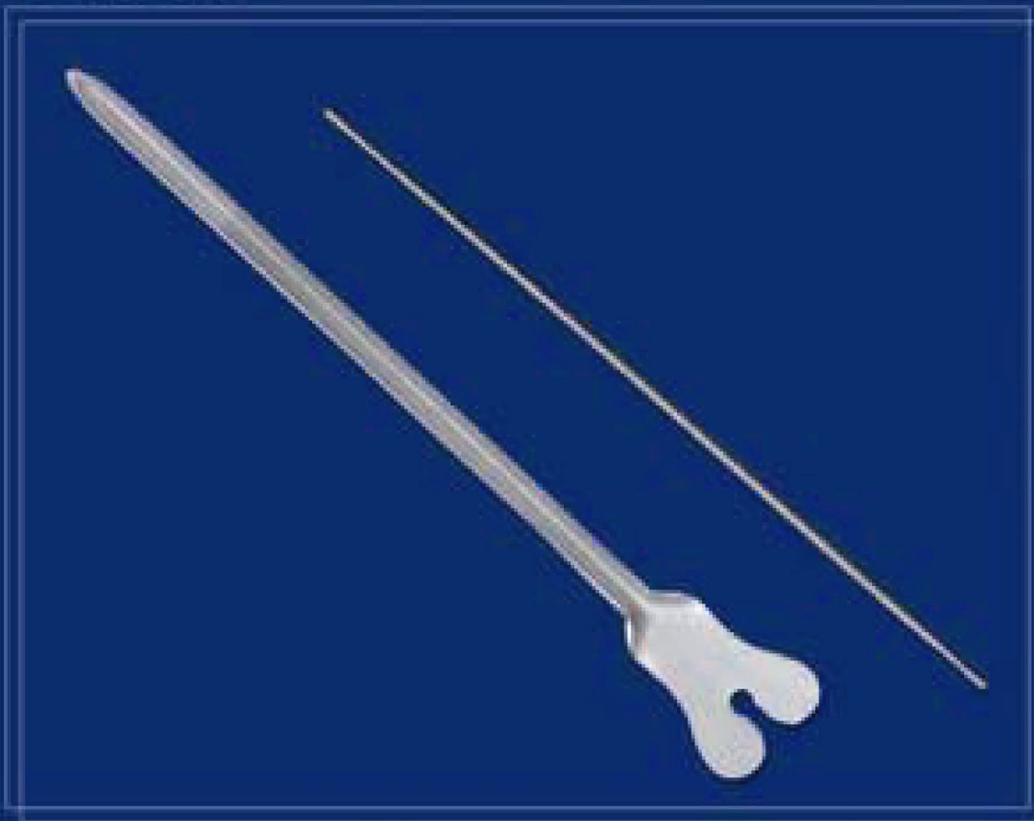



54.0102.13 13 cm
54.0106.14 14.5 cm
54.0110.16 16 cm



54.0114.13 13 cm
54.0118.14 14.5 cm
54.0122.16 16 cm



54.0126.11 11.5 cm
54.0130.13 13 cm
54.0134.14 14.5 cm
54.0138.16 16 cm
54.0142.18 18 cm
54.0146.20 20 cm
2 mm ø



54.0150.11 11.5 cm
54.0154.13 13 cm
54.0158.14 14.5 cm
54.0162.16 16 cm
54.0166.18 18 cm
54.0170.20 20 cm
1 mm ø



FARRELL
(Lathbury-Uebe)
54.0174.12 12 cm 0.9 mm ø
54.0178.14 14 cm 0.9 mm ø
54.0182.16 16.5 cm 1.1 mm ø



54.0186.14 14.5 cm
54.0190.16 16 cm



54.0194.13 13 cm
54.0198.14 14.5 cm
54.0202.16 16 cm
2 mm ø

53

Varicose Vein Probe Set
Krampfader-Besteck
Sonda Para Varices

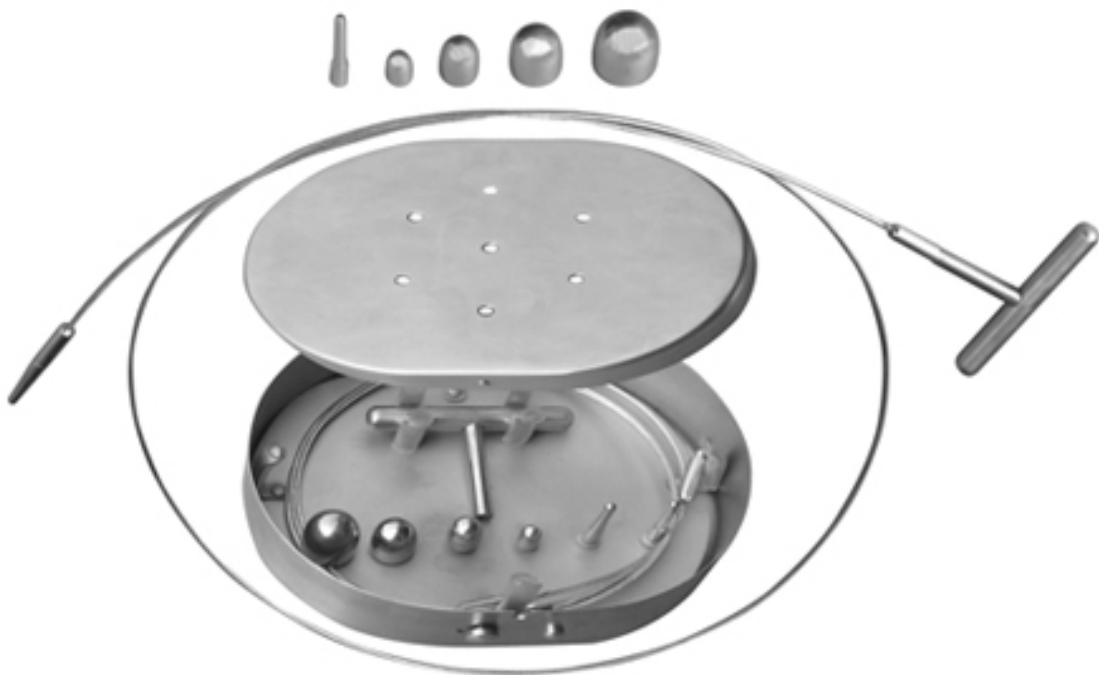

NABATOFF
54.0210.00
135 X 100 x 25 mm
Compl.



Cardiovascular





ANDERSON-ADSON
 48.1288.20 20 cm sharp-scharf-agudo
 48.1289.20 20 cm blunt-stumpf-romo



ADSON-BABY
 55.0105.16 16 cm sharp - scharf - agudo
 55.0106.16 16 cm blunt - stumpf - romo

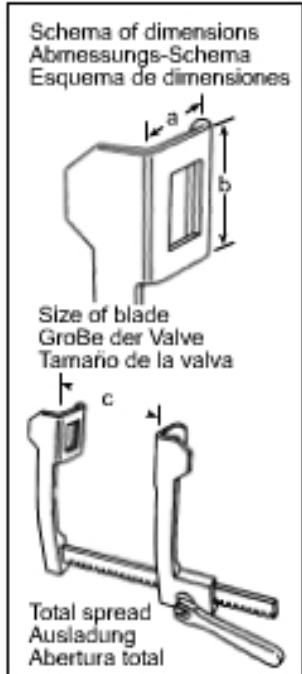

for babies
für Säuglinge
para bebés

FINOCCHIETTO - INFANT

	a	b	c
55.0110.01	15 mm	15 mm	75 mm

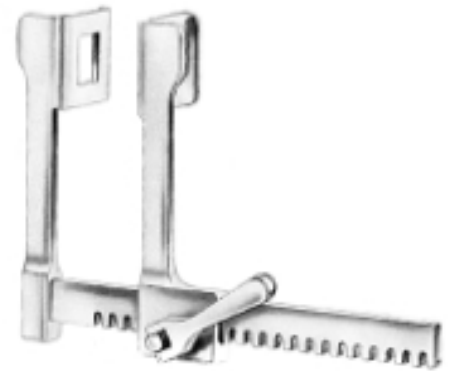

FINOCCHIETTO - BABY

	a	b	c
55.0114.75	18 mm	20 mm	75 mm



FINOCCHIETTO

	a	b	c
55.0118.01	40 mm	40 mm	165 mm
55.0122.02	45 mm	65 mm	200 mm
55.0126.03	70 mm	65 mm	250 mm



BAILEY-BABY
55.0130.14
14 cm



BAILEY
55.0134.16
16 cm



CUSHING
48.0732.20 - 48.0752.20
20 cm



CUSHING
48.0756.24 - 48.0776.24
24 cm



DARLING
48.1352.18
18 cm



DARLING
48.1356.18
18 cm

55

Nerve Hooks, Tourniquets
 Nervhakchen, Tourniquets
 Separadores de Nervios, Tomiquetes

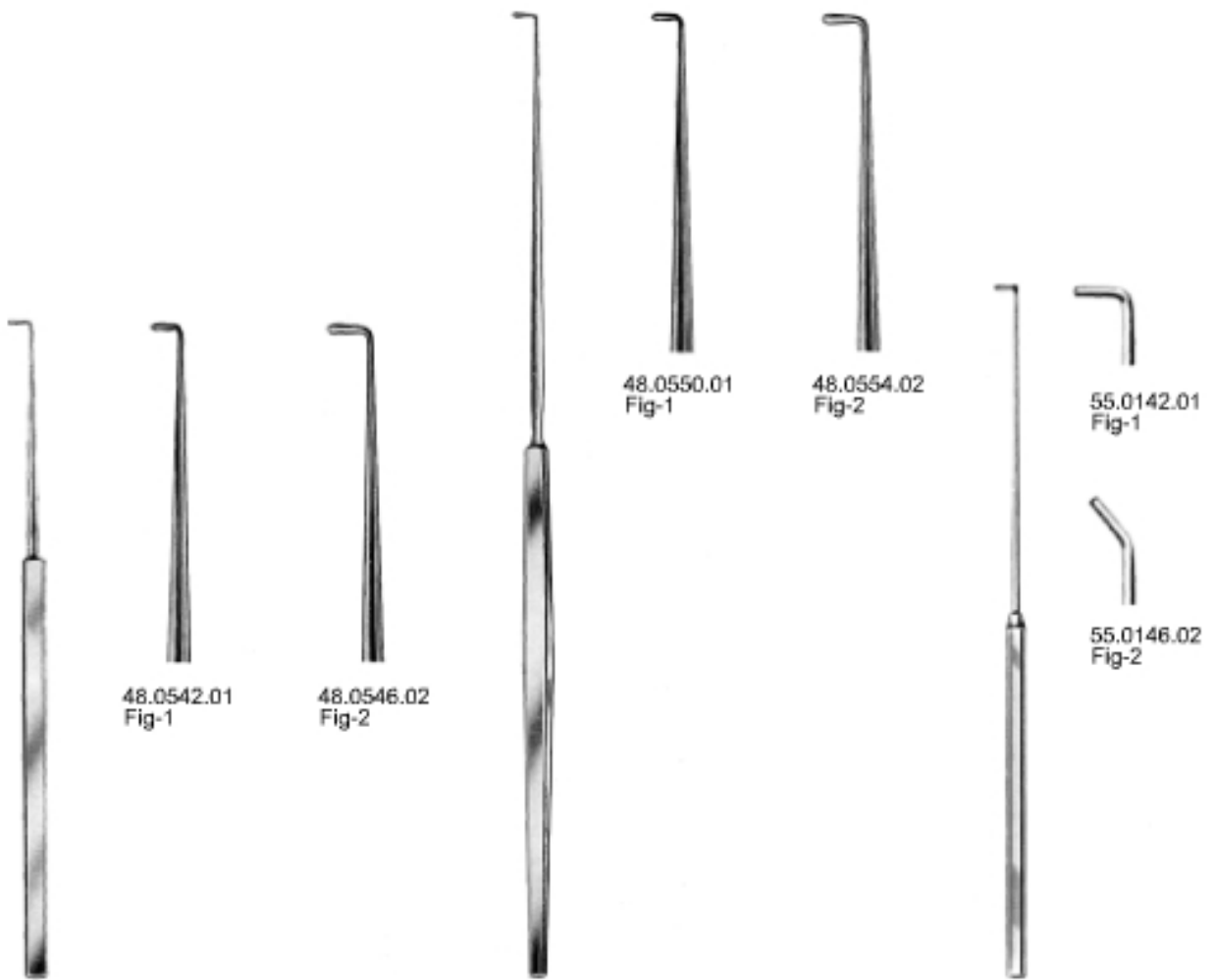

CUSHING
 48.0542.01 - 48.0546.02
 19 cm

CUSHING
 48.0550.01 - 48.0554.02
 28 cm

CRILE
 55.0142.01 - 55.0146.02
 20 cm





DEAVER	L	B
48.0992.30	30.5 cm	25 mm
48.0996.33	33 cm	25 mm
48.1000.30	30.5 cm	38 mm
48.1004.30	30.5 cm	50 mm
48.1008.30	30.5 cm	75 mm

DEAVER
48.0980.30
30 cm

DEAVER
48.0984.30
30 cm

DEAVER
48.0988.30
30 cm



POLLOSON
55.0156.27
27 cm

POLLOSON
55.0160.27
27 cm

HARRINGTON
48.0912.32 32 cm 127 x 40 mm
48.0916.32 32 cm 127 x 62 mm
48.0920.32 32 cm 175 x 64 mm

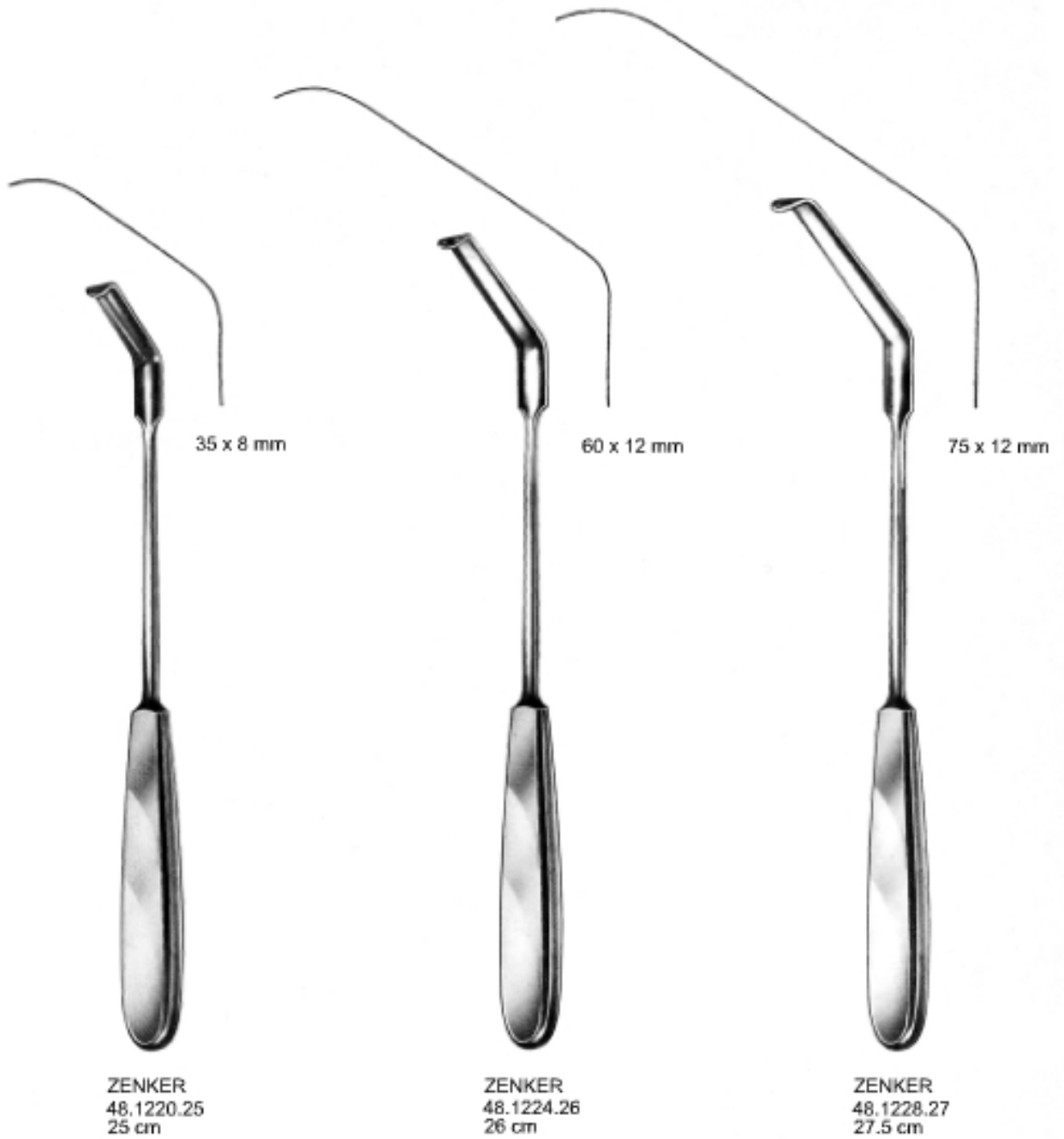

Retractor for Vascular Surgery
 Wundspreizer für Gefäßchirurgie
 Separadores Vasculares



ROSS
 55.0164.01 - 55.0184.06
 27 cm



55.0164.01
 fig- 1



55.0168.02
 fig- 2



55.0172.03
 fig- 3



55.0176.04
 fig- 4



55.0180.05
 fig- 5



55.0184.06
 fig- 6



CRAWFORD
 55.0188.01 - 55.0192.02
 19 cm



55.0188.01
 15 x 15 mm

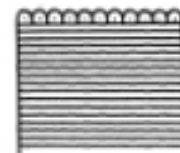

55.0192.02
 15 x 23 mm

55

Bone and Rib Shears, Periosteotomes
 Knochen und Rippenscheren, Raspatorien
 Cizallas para Huesos Y Costillas, Periostotomos

Periosteotomes



DOYEN
 55.0196.17 - 55.0200.17
 17 cm



55.0196.17



55.0204.17



55.0200.17



55.0208.17



DOYEN
 55.0204.17 - 55.0208.17
 17 cm



LAMBOTTE
 55.0212.21 - 55.0224.21
 21 cm

55.0212.21	10 mm
55.0216.21	15 mm
55.0220.21	20 mm
55.0224.21	25 mm
width	
breite	
ancho	

Bone and Rib Shears



STILLE
 55.0228.21
 21 cm



55.0232.22
 22 cm

Bulldog Clamps
Bulldogklemmen
Clamps Bulldog

	55.0236.08	55.0240.10	55.0244.12	55.0237.08	55.0241.10	55.0245.12	
	Length Largo	50 mm	50 mm	60 mm	50 mm	50 mm	60 mm
	Jaws Boca	08 mm	10 mm	12 mm	08 mm	10 mm	12 mm
	Weight Gewicht Peso	03 gr.	03 gr.	03 gr.	03 gr.	03 gr.	03 gr.
Pressure Druck Presion	50 gr.	50 gr.	50 gr.	50 gr.	50 gr.	50 gr.	

55.0236.08 - 55.0245.12

	DIEFFENBACH		DIEFFENBACH		JOHNS HOPKINS
3.5	55.0252.03		55.0253.03		
3.0	55.0256.05		55.0257.05		55.0260.05
6.0	55.0248.06	55.0249.06			
6.5					55.0264.06
7.5					55.0268.07

55

Atrauma Bulldog Clamps
Atrauma, Bulldogklemmen
Atrauma Clamps Bulldog

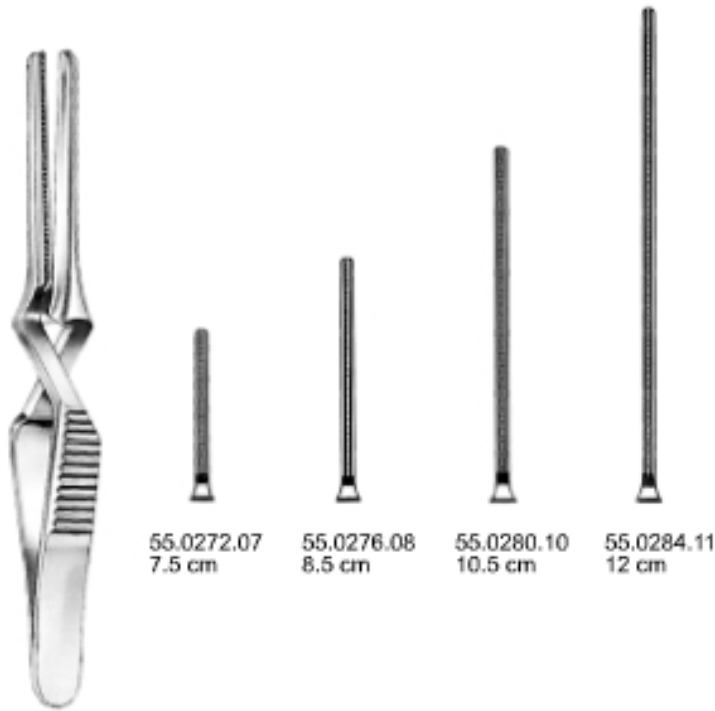

55.0272.07 - 55.0284.12

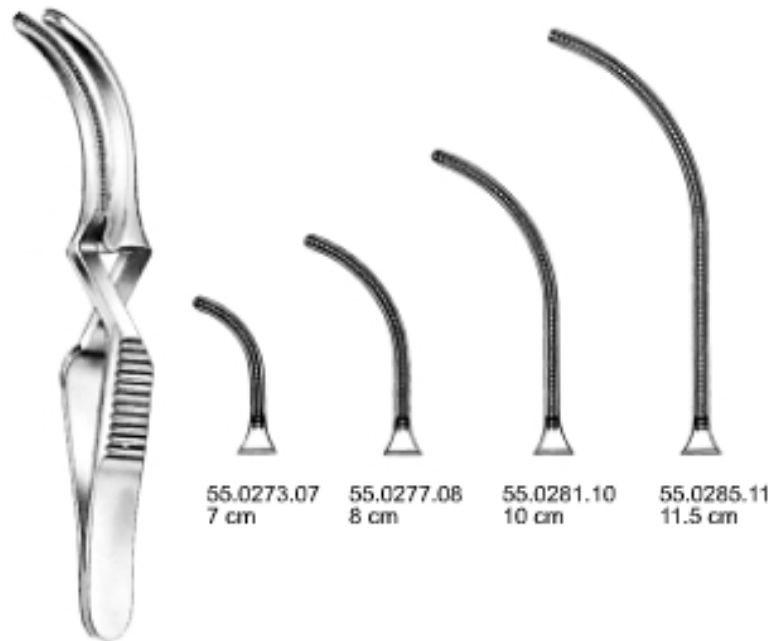

55.0273.07 - 55.0285.12

Atrauma Cardiovascular Forceps
 Atrauma Cardiovascular . Klemmen
 Atrauma Pinzas, Clamps Cardiovascular



GLOVER
 55.0289.06
 5 cm



SANTULLI
 55.0293.07
 7 cm

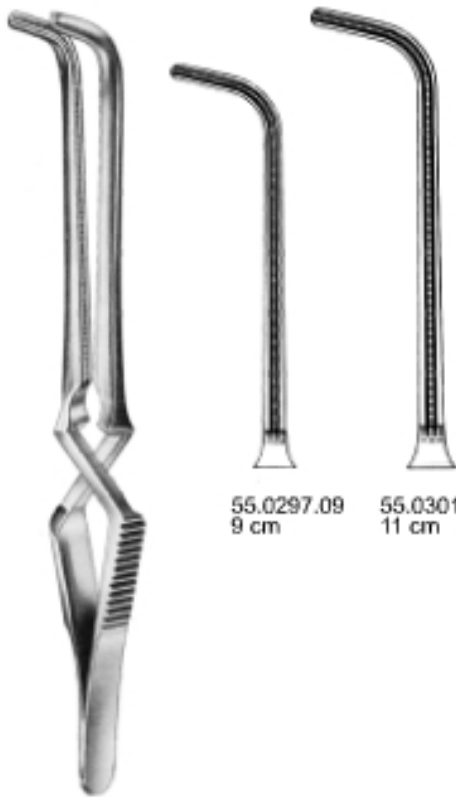

GREGORY-SOFT
 55.0297.09 - 55.0301.11

55.0297.09
 9 cm

55.0301.11
 11 cm



DE BAKEY - SATINSKY
 55.0305.10
 10 cm



DE BAKEY - CAROTID
 55.0309.09
 9 cm

55.0309.09
 9 cm

55

Atrauma Bulldog Clamps
 Atrauma, Bulldogklemmen
 Atrauma Clamps Bulldog



55.0312.06
6 cm

55.0316.07
7 cm

55.0320.09
9 cm

55.0324.11
11 cm

GLOVER
55.0312.06 - 55.0324.11



55.0313.06
6 cm

55.0317.07
7 cm

55.0321.09
9 cm

55.0325.11
11 cm

GLOVER
55.0313.06 - 55.0325.11

Atrauma Dissecting Forceps
 Atrauma Pinzetten
 Pinzas de Diseccion Atrauma

1.5 mm



55.0328.16 16 cm
 55.0332.20 20 cm
 55.0336.24 24 cm

DE BAKEY
 55.0328.16 - 55.0336.24

2.0 mm



55.0340.16 16 cm
 55.0344.20 20 cm
 55.0348.24 24 cm
 55.0352.30 30 cm

DE BAKEY
 55.0340.16 - 55.0352.30

2.0 mm



55.0341.16 16 cm
 55.0345.20 20 cm
 55.0349.24 24 cm
 55.0353.30 30 cm

DE BAKEY
 55.0341.16 - 55.0353.30

2.0 mm



55.0356.16 16 cm
 55.0360.20 20 cm

COOLEY
 55.0356.16 - 55.0360.20

2.7 mm



55.0364.16 16 cm
 55.0368.20 20 cm
 55.0372.24 24 cm
 55.0376.30 30 cm

DE BAKEY
 55.0364.16 - 55.0376.30

3.5 mm



55.0380.16 16 cm
 55.0384.20 20 cm
 55.0388.24 24 cm
 55.0392.30 30 cm

DE BAKEY
 55.0380.16 - 55.0392.30

55

Atrauma Cardiovascular Forceps
Atrauma Cardiovascular, Klemmen
Atrauma Pinzas Clamps Cardiovascular



DE BAKEY
55.0397.28
28 cm

DE BAKEY
55.0401.30
30 cm

Atrauma Cardiovascular Forceps
 Atrauma Cardiovascular, Klemmen
 Atrauma Pinzas Clamps Cardiovascular

55



DE BAKEY
 55.0405.16
 16 cm



DE BAKEY
 55.0409.19 - 55.0413.23



55.0409.1
 99 cm

55.0413.23
 23 cm



DE BAKEY
 55.0417.24
 24 cm

55

Atrauma Cardiovascular Forceps
 Atrauma Cardiovascular, Klemmen
 Atrauma Pinzas Clamps Cardiovascular



POTTS
 55.0419.22 - 55.0421.22



POTTS
 55.0424.21 - 55.0428.22

POTTS
 55.0425.21 - 55.0429.22

Atrauma Cardiovascular Forceps
Atrauma Cardiovascular, Klemmen
Atrauma Pinzas Clamps Cardiovascular

55



DE BAKEY
55.0433.19 - 55.0437.20

55.0433.19
19 cm

55.0437.20
20 cm



POTTS
55.0441.22
22 cm



POTTS
55.0445.22
22 cm

52.0445.22
22 cm

55

Atrauma Cardiovascular Forceps
Atrauma Cardiovascular, Klemmen
Atrauma Pinzas Clamps Cardiovascular



DE BAKEY
55.0449.25
25 cm



DE BAKEY
55.0453.26
26 cm

Atrauma Cardiovascular Forceps
Atrauma Cardiovascular, Klemmen
Atrauma Pinzas Clamps Cardiovascular



LEES
55.0457.25
25 cm



LEES
55.0461.23 - 55.0465.25
23 cm



55.0461.23
23 cm



55.0465.25
25 cm

55

Atrauma Cardiovascular Forceps
Atrauma Cardiovascular, Klemmen
Atrauma Pinzas Clamps Cardiovascular

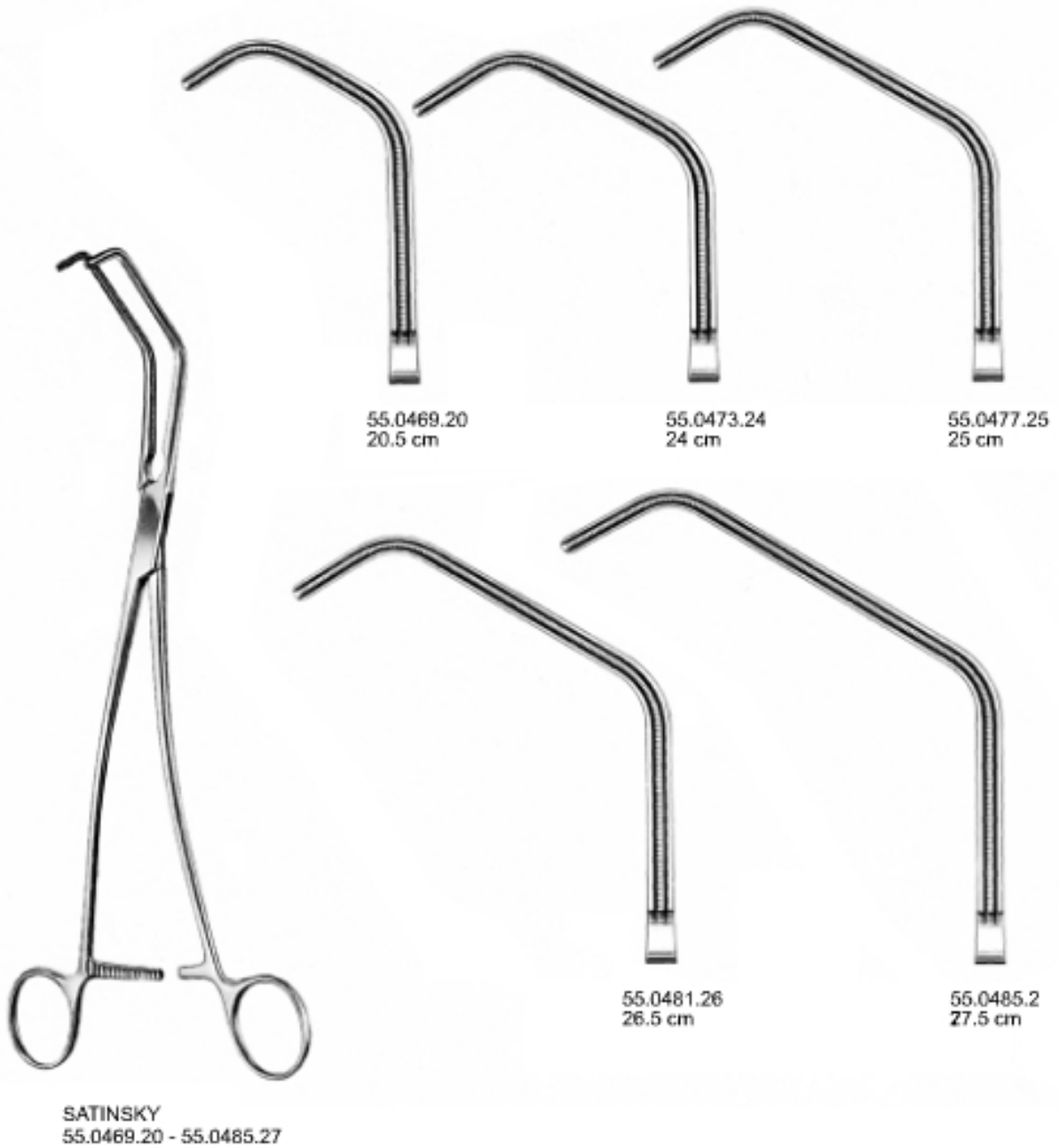

Atrauma Cardiovascular Forceps
 Atrauma Cardiovascular, Klemmen
 Atrauma Pinzas Clamps Cardiovascular

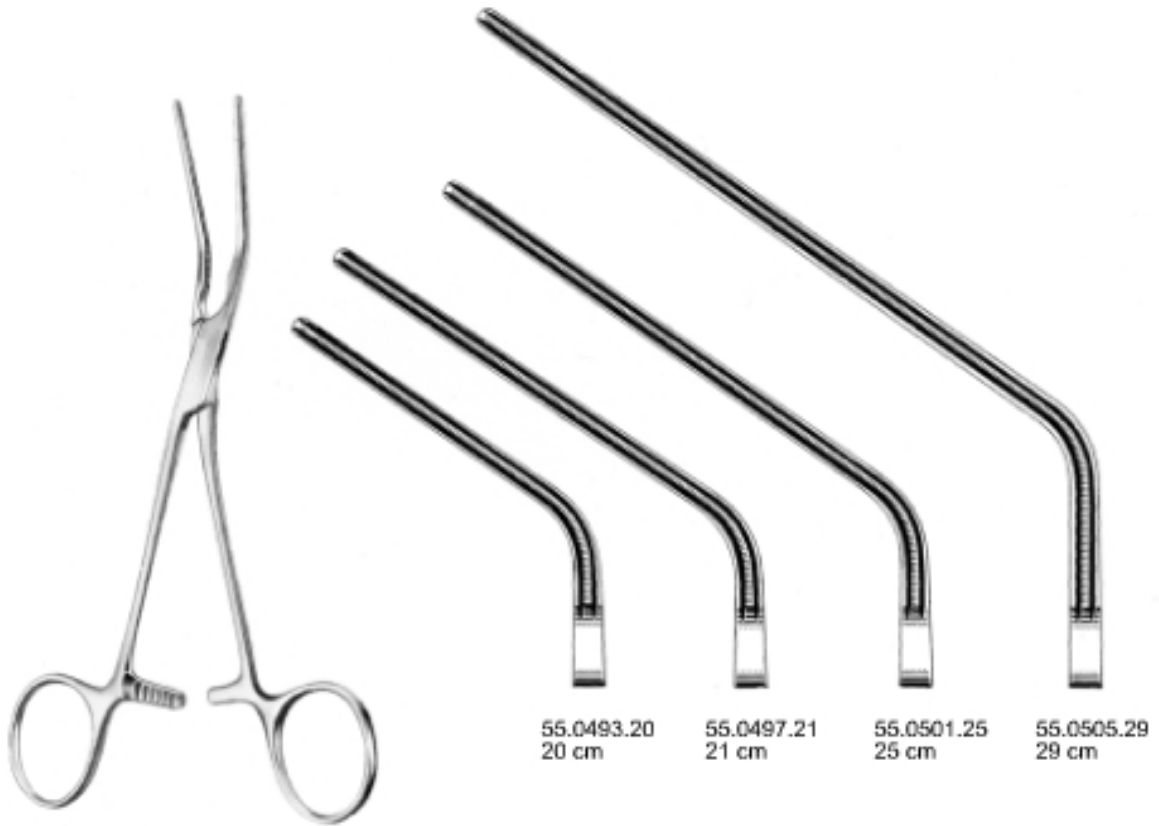

55.0493.20 - 55.0505.29

55.0493.20
20 cm

55.0497.21
21 cm

55.0501.25
25 cm

55.0505.29
29 cm

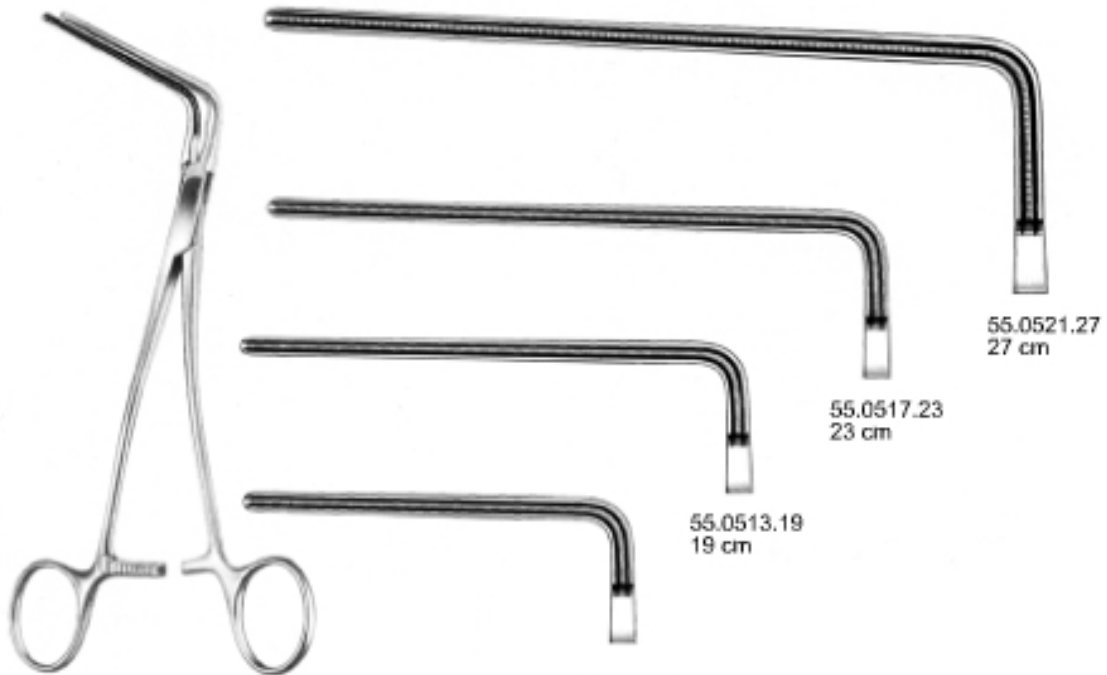

DE BAKEY
55.0509.18 - 55.0521.27

55.0509.18
18 cm

55.0517.23
23 cm

55.0521.27
27 cm

55

Atrauma Cardiovascular Forceps
 Atrauma Cardiovascular, Klemmen
 Atrauma Pinzas Clamps Cardiovascular



55.0524.21 - 55.0536.31



55.0524.21
21 cm



55.0528.23
23 cm



55.0532.27
27 cm



55.0536.31
31 cm



55.0525.21 - 55.0537.31



55.0525.21
21 cm



55.0529.23
23 cm



55.0533.27
27 cm



55.0537.31
31 cm

Atrauma Cardiovascular Forceps
 Atrauma Cardiovascular, Klemmen
 Atrauma Pinzas Clamps Cardiovascular



55.0541.16 16 cm 55.0545.17 17 cm 55.0549.18 18 cm

DERRA
 55.0541.16 - 55.0549.18

BECK
 55.0553.17
 17 cm



GLOVER
 55.0557.17
 17 cm

55.0561.17
 17 cm

DE BAKEY
 55.0564.17
 17 cm



DE BAKEY
 55.0569.16 - 55.0573.17

55.0569.16
 16 cm

55.0573.17
 17 cm



COOLEY
 55.0577.16 - 55.0581.17

55.0577.16
 16 cm

55.0581.17
 7 cm



COOLEY
 55.0585.17
 17 cm



COOLEY
 55.0589.16
 16 cm



BECK
 55.0593.17
 17 cm

Atrauma Cardiovascular Forceps
 Atrauma Cardiovascular, Klemmen
 Atrauma Pinzas Clamps Cardiovascular



DE BAKEY
 55.0597.10
 10 cm



DE BAKEY
 55.0600.12
 12 cm



DE BAKEY
 55.0601.11
 11 cm



DE BAKEY
 55.0605.12
 12 cm



DE BAKEY
 55.0609.13
 13 cm

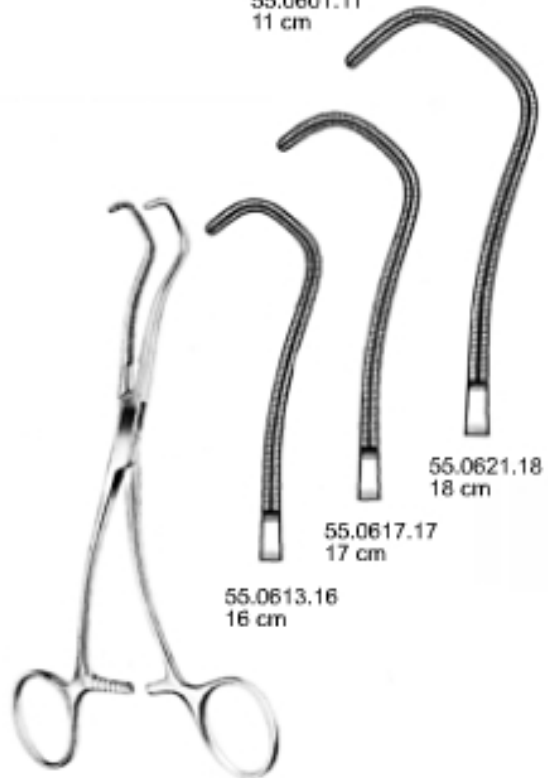

COOLEY-DERRA
 55.0613.16 - 55.0621.18

55

Atrauma Cardiovascular Forceps
 Atrauma Cardiovascular, Klemmen
 Atrauma Pinzas Clamps Cardiovascular



COOLEY
 55.0624.17
 17 cm



COOLEY
 55.0625.17
 17 cm



COOLEY
 55.0629.17
 17 cm



COOLEY
 55.0633.17
 17 cm



COOLEY
 55.0637.15
 15 cm



COOLEY
 55.0641.16
 16 cm



COOLEY
 55.0645.17
 17 cm

Atrauma Cardiovascular Forceps
 Atrauma Cardiovascular, Klemmen
 Atrauma Pinzas Clamps Cardiovascular



DE BAKEY-MOSQUITO
 55.0648.12
 12 cm

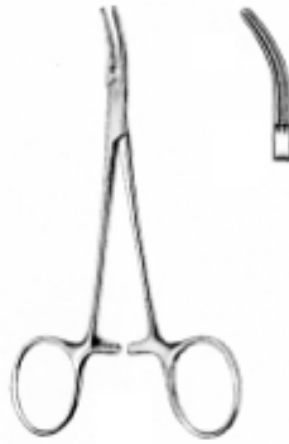

DE BAKEY-MOSQUITO
 55.0649.12
 12 cm



DE BAKEY-RANKIN
 55.0652.16 - 55.0653.16
 16 cm



DE BAKEY-MOSQUITO
 55.0656.15 - 55.0657.15
 15 cm



DE BAKEY
 55.0661.15
 15 cm



DE BAKEY
 55.0665.1
 17 cm

55

Atrauma Cardiovascular Forceps
Atrauma Cardiovascular, Klemmen
Atrauma Pinzas Clamps Cardiovascular



DE BAKEY
55.0669.16
16 cm



DE BAKEY
55.0673.15
15 cm



DE BAKEY-PEAN
55.0676.14 - 52.0688.20

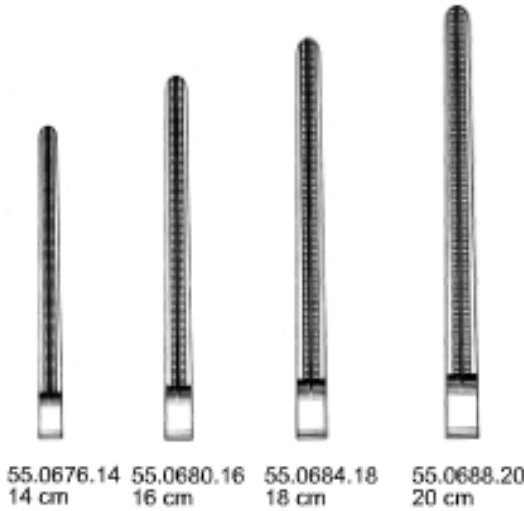

55.0676.14 14 cm
55.0680.16 16 cm
55.0684.18 18 cm
55.0688.20 20 cm



DE BAKEY-PEAN
55.0677.14 - 52.0689.20

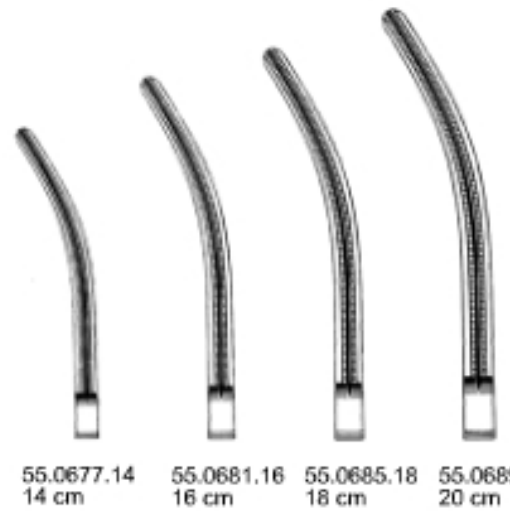

55.0677.14 14 cm
55.0681.16 16 cm
55.0685.18 18 cm
55.0689.20 20 cm

Atrauma Cardiovascular Forceps
Atrauma Cardiovascular, Klemmen
Atrauma Pinzas Clamps Cardiovascular

55



55.0693.26 - 55.0705.33



45.0545.18
 25°



45.0553.18
 45°



45.0561.18
 60°



45.0567.18
 90°

45.0545.18 - 45.0567.18
 18 cm



45.0571.18
 25°



45.0575.18
 45°



45.0579.18
 60°



45.0583.18
 90°

45.0571.18 - 45.0583.18
 18 cm

Thorax & Vascular Scissors
 Thoraxscheren, Gefäßcheren
 Tijeras Torácicas Y Vasculares



FAVALCIO
 55.0741.15
 15 cm



DE BAKEY
 55.0745.15
 15.5 cm
 blunt - stumpf - romo



DE BAKEY
 55.0748.15
 15.5 cm
 sharp - scharf - agudo



POTTS-SMITH
 55.0753.19 - 55.0761.19
 19 cm



55.0753.19
 25



55.0757.19
 40



55.0761.19
 60



52.0765.21 21 cm
 52.0769.24 24 cm



POTTS-DE MARTEL
 55.0765.21 - 55.0769.24

55

Thorax & Vascular Scissors
 Thoraxscheren, Gefäßchren
 Tijeras Toracicas Y Vasculares

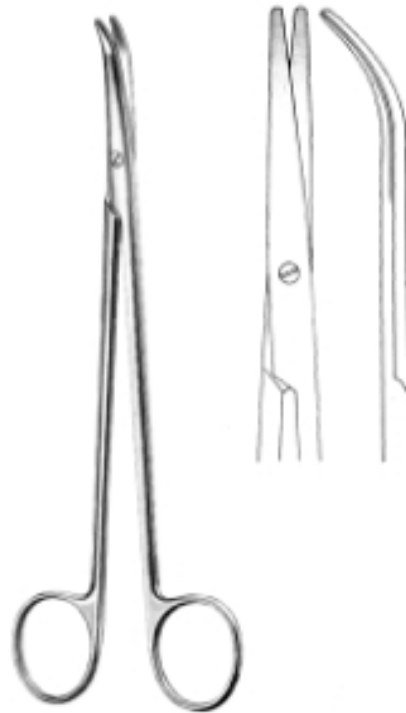

THOREK
 42.0869.19
 19 cm



SATINSKY
 42.0865.18
 18 cm



KLINKENBERGH
 42.0869.23
 23 cm

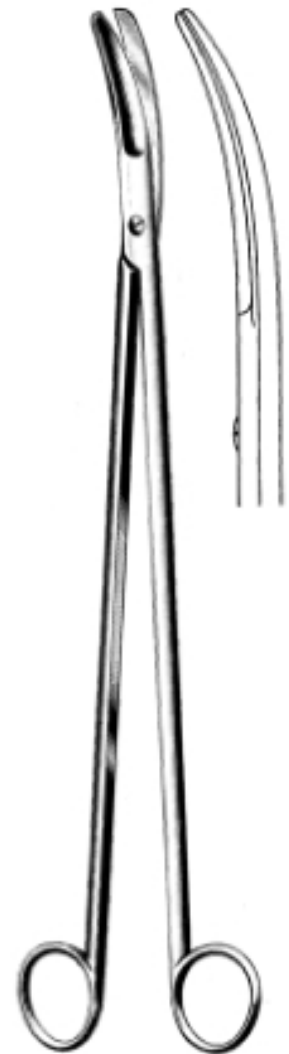

CRAFOORD
 55.0771.30
 30 cm



DIETRICH
55.0775.18 - 55.0791.17

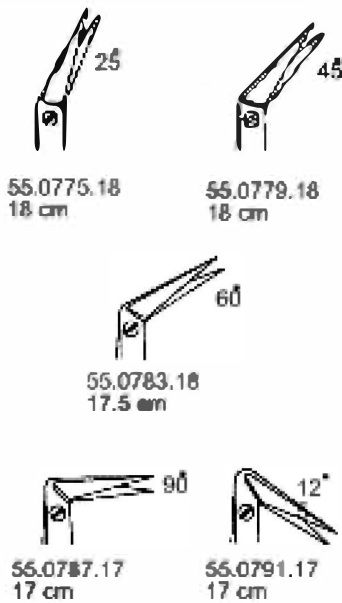

TC GOLD



DE BAKEY
(Potts-Smith)
55.0795.19 - 55.0803.19
19 cm

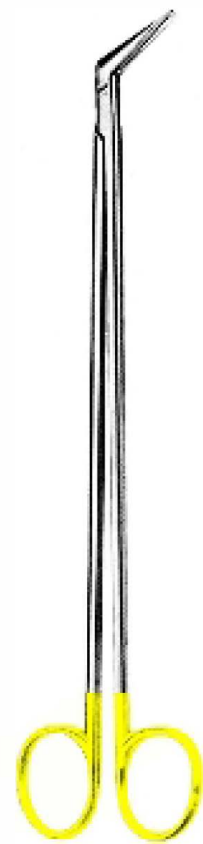
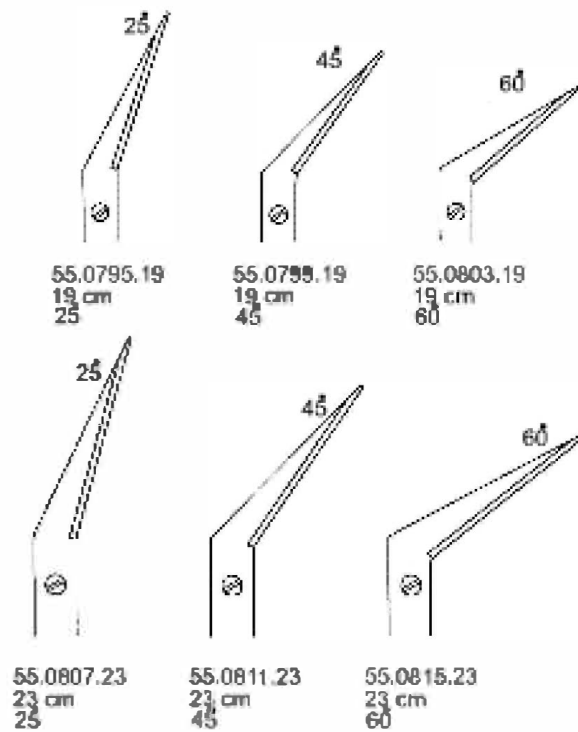

DE BAKEY
(Potts-Smith)
55.0807.23 - 55.0815.23
23 cm

55

Scissors With Tungsten Carbide Inserts
 Scheren Mit Hartmetalleinsatzen
 Tijeras con filos de Carburo de Tungsteno

TC GOLD



METZENBAUM FINO
 42.1117.18 - 42.1109.23



42.1117.18
 18 cm



42.1113.20
 20 cm



42.1109.23
 23 cm



METZENBAUM FINO
 55.0819.18 - 55.0827.23



55.0819.18
 18 cm

S - shaped
 S - formig gebogen
 curva en S



55.0823.20
 20 cm

S - shaped
 S - formig gebogen
 curva en S



55.0827.23
 23 cm

S - shaped
 S - formig gebogen
 curva en S

TC GOLD

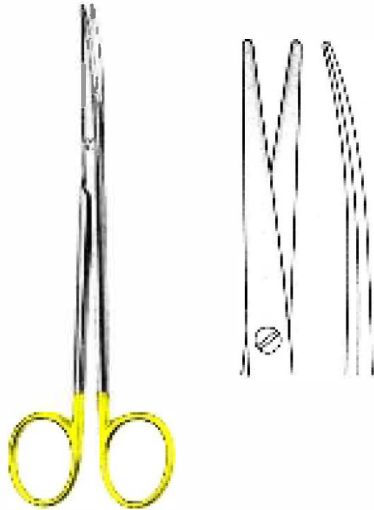

TOENNIS-ADSON
 42.1137.17
 17 cm

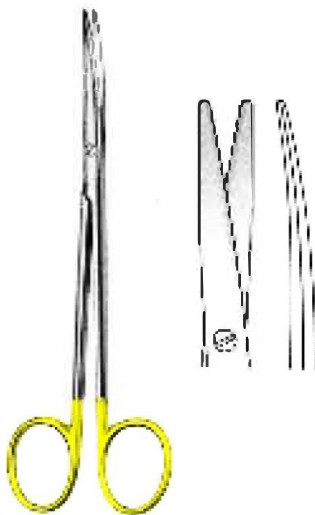

METZENBAUM-LAHEY
 42.1133.14
 14 cm



METZENBAUM
 42.1129.23 - 42.1125.20

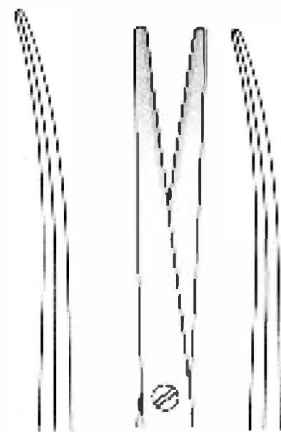

42.1129.23
 23 cm

42.1125.20
 20 cm

55

Tubing Clamps
Schlauchklemmen
Pinzas Para Tubos



43.0820.15
15 cm

43.0824.18
18 cm

43.0828.20
20 cm

43.0820.15 - 43.0828.20



43.0832.15
15.5 cm

43.0836.18
18 cm

43.0840.20
20 cm

43.0832.15 - 43.0840.20



PRESBYTERIAN

43.0844.16 16 cm

43.0848.18 18 cm



KLINIKUM BERLIN

43.0852.14

14.5 cm

Dissecting and Ligature Forceps
Preparier und Ligaturklemmen
Oinzas para Preparacions Y Ligaduras

55



GEMINI
55.0831.13 - 55.0851.28



55.0831.13
13 cm



55.0835.18
18 cm



55.0841.20
20 cm



43.0845.23
23 cm



43.0851.28
28 cm

55

Dissecting and Ligature Forceps
Preparier und Ligaturklemmen
Oinzas para Preparacions Y Ligaduras



OVERHOLT
43.0285.18
18.5 cm



OVERHOLT
43.0289.20
20.5 cm



OVERHOLT
43.0293.21
21.5 cm



OVERHOLT
43.0297.21
21.5 cm



S-shaped
S-forming gebogen
curvas en S



LOVELACE
 55.0858.20
 20 cm



LOVELACE
 55.0859.20
 20 cm



55.0862.25 - 55.0866.26



55.0862.25
 25 cm



55.0866.26
 26 cm



55.0870.18 - 55.0878.23



55.0870.18
 18 cm



55.0874.20
 20 cm



55.0878.23
 23 cm

55

Tissue and Organ Holding Forceps
Gewebe und Organ.Faßzangen
Pinza Para Tejidos Y Organos



SEMB
55.0883.24
24 cm



PRICE-THOMAS
55.0885.2
22 cm



PRICE-THOMAS
55.0889.2
22 cm



ALLIS-ATRAUMA
55.0893.16 - 55.0905.30



55.0893.16
16 cm



55.0897.20
20 cm



55.0901.25
25 cm



55.0905.30
30 cm



BABCOCK-ATRAUMA
55.0908.16 - 55.0912.20



55.0908.16
16 cm



55.0912.20
20 cm

Needle Holders With Tungsten Carbide Inserts
 Nadelhalter Mit Hartmetalleinsätzen
 Porta-Agujas Con Filos De Carburo De Tungsteno

TC GOLD



MICRO VASCULAR
 46.0564.14 - 46.0570.23



46.0564.14
 14 cm



46.0566.18
 18 cm



46.0568.20
 20 cm



46.0570.23
 23 cm

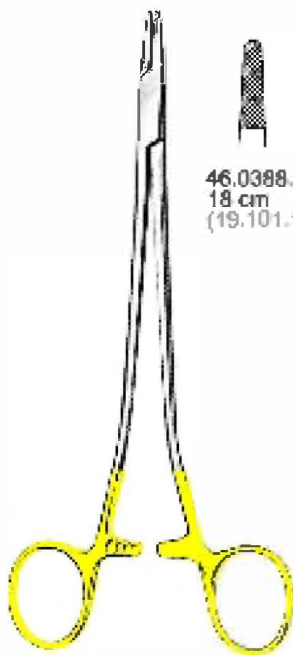

SAROT
 46.0388.18 - 46.0392.26



46.0388.18
 18 cm
 (19.101.18)



46.0390.20
 20 cm
 (19.102.20)



46.0392.20
 26 cm
 (19.103.26)

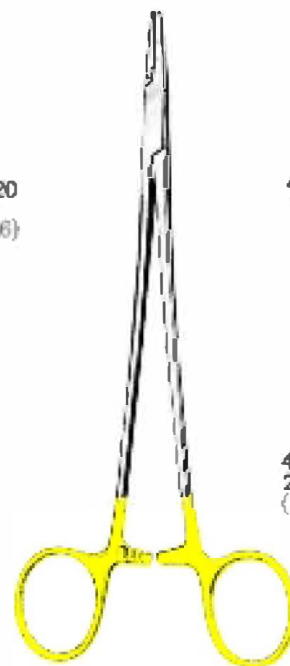

DE BAKEY
 46.0604.18 - 46.0624.37



46.0604.18
 18 cm



46.0608.20
 20 cm
 (19.114.20)



46.0612.23
 23 cm
 (19.115.23)



46.0616.26
 26 cm
 (19.116.26)



46.0620.31
 30 cm
 (19.117.31)



46.0624.37
 37 cm
 (19.118.37)

55

Needle Holders, Wire Twisting Forceps With Tungsten Carbide Inserts
Nadelhalter, Drahtzangen Mit Hartmetalleinsätzen
Porta-Agujas, Pinzas Para Torcer Hilos Con Filos De Carburo De Tungsteno

TC GOLD

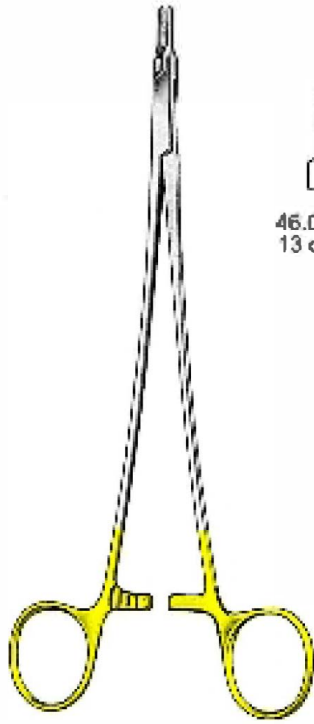

RYDER VASCULAR
46.0522.13 - 46.0542.26



46.0522.13
13 cm



46.0526.15
15 cm



46.0530.18
18 cm



46.0534.20
20 cm



46.0538.23
23 cm



46.0542.26
26 cm

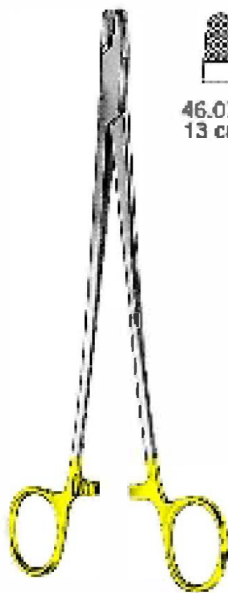

STERNUM
46.0738.13 - 46.0742.18



46.0738.13
13 cm



46.0742.18
18 cm



46.0746.15 - 46.0750.18



46.0746.15
15 cm



46.0750.18
18 cm



46.0758.18
18.5 cm



TC GOLD



POTTS-SMITH
 55.0916.22
 22 cm
 (19.128.22)



HEPP-SCHIEDEL
 55.0920.18
 18 cm
 (19.127.18)



CASTROVIEJO
 55.0924.14 - 55.0933.21

smooth
glatt
lisas



55.0924.14
 14 cm
 smooth
glatt
lisas



55.0928.18
 18 cm
 Micro profile
Mikroprofil
profil micro



55.0932.21
 21 cm
 Micro profile
Mikroprofil
profil micro



55.0925.14
 14 cm
 smooth
glatt
lisas



55.0929.18
 18 cm
 Micro profile
Mikroprofil
profil micro



55.0933.21
 21 cm
 Micro profile
Mikroprofil
profil micro

55

Endarterectomy
Endarterektomie
Endarterectomia



ROBB
55.0937.24
24 cm



ROBB
55.0941.24
24 cm



ROBB
55.0945.24
24 cm



ROBB
55.0949.24
24 cm

Endarterectomy
Endarterektomie
Endarterectomia

55

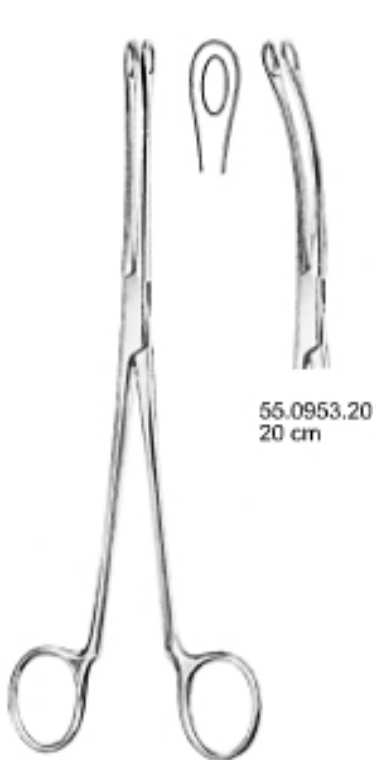

55.0953.20
20 cm

BIAKE
55.0952.20
20 cm



SACHS
55.0957.21
21 cm



SACHS
55.0961.21
21 cm

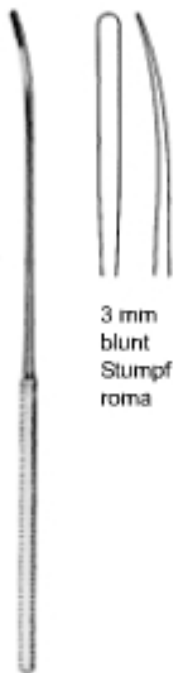

3 mm
blunt
Stumpf
roma

55.0965.18 18.5 cm
55.0969.21 21.5 cm

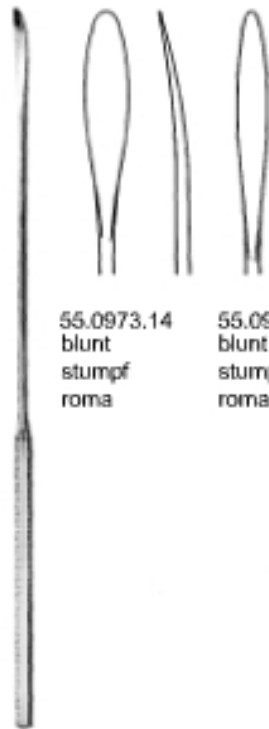

55.0973.14
blunt
stumpf
roma

55.0977.24
blunt
stumpf
roma

55.0973.14 14.5 cm
55.0977.24 23.5 cm



55.0983.23
23 cm

55

Instruments Set for Surgical Decompression of the Thoracic Outlet Syndrome
Instrumentarium Zur Transaxillaren Operation bei Schulter-Gürtelsyndrom
Instrumental para la Cururgia del Thoracic Outlet Syndrome

TC GOLD

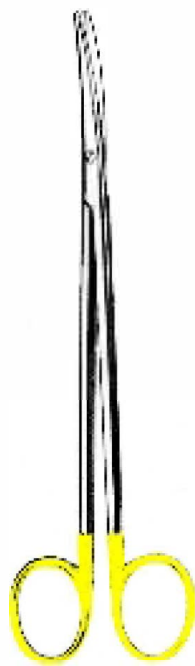

METZENBAUM-LAHEY
42.1133.14
14 cm

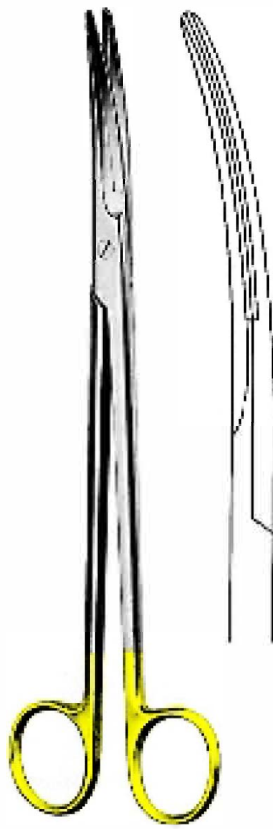

MAYO
55.0987.23
23 cm

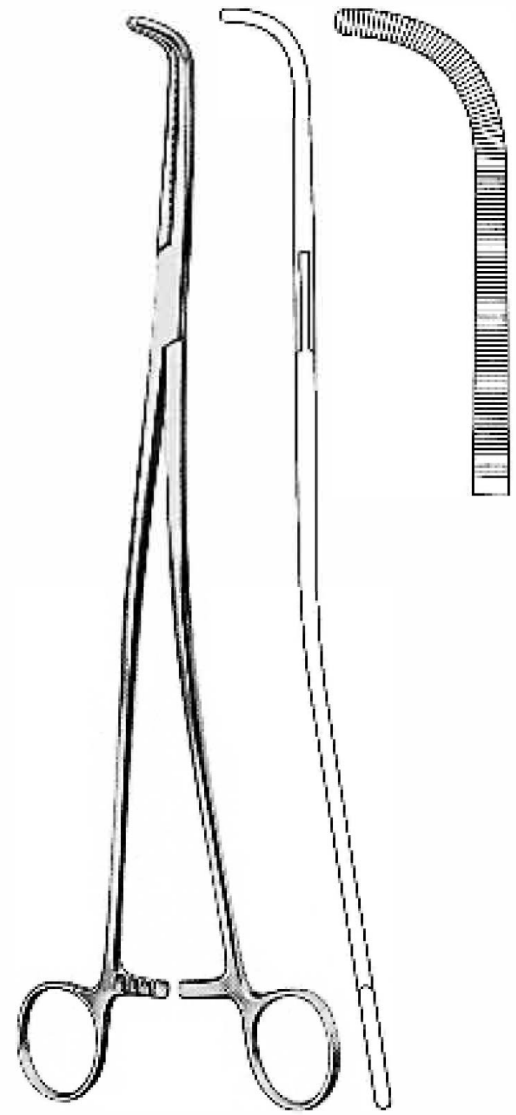

D'ALLAINES-BEAUJEAN
55.0991.21
21 cm

Instruments Set for Surgical Decompression of the Thoracic Outlet Syndrome
 Instrumentarium Zur Transaxillaren Operation bei Schulter-Gürtelsyndrom
 Instrumental para la Cururgia del Thoracic Outlet Syndrome

55



DOYEN-BEAUJEAN
 55.0995.35 - 55.0999.45
 23 cm

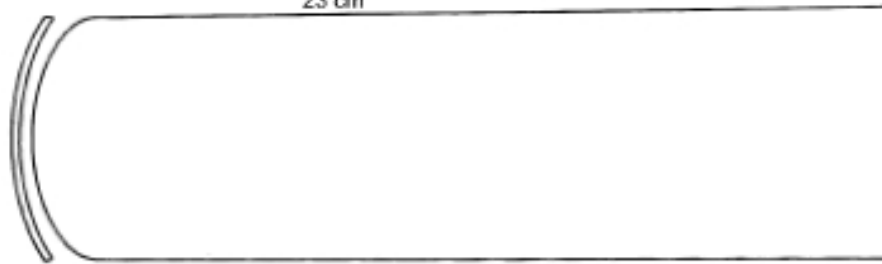

55.0995.35
 120x35 mm

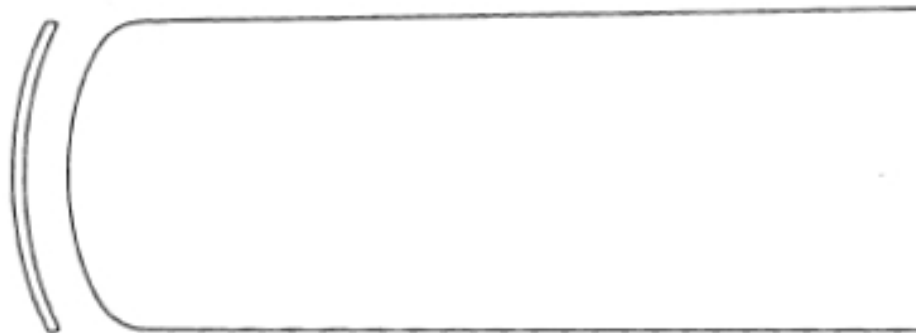

55.0999.45
 125x45 mm

55

Instruments Set for Surgical Decompression of the Thoracic Outlet Syndrome
Instrumentarium Zur Transaxillaren Operation bei Schulter-Gürtelsyndrom
Instrumental para la Cururgia del Thoracic Outlet Syndrome



ANDERSON-ADSON
48.1288.20 20 cm sharp-scharf-agudo
48.1289.20 20 cm blunt-stumpf-romo

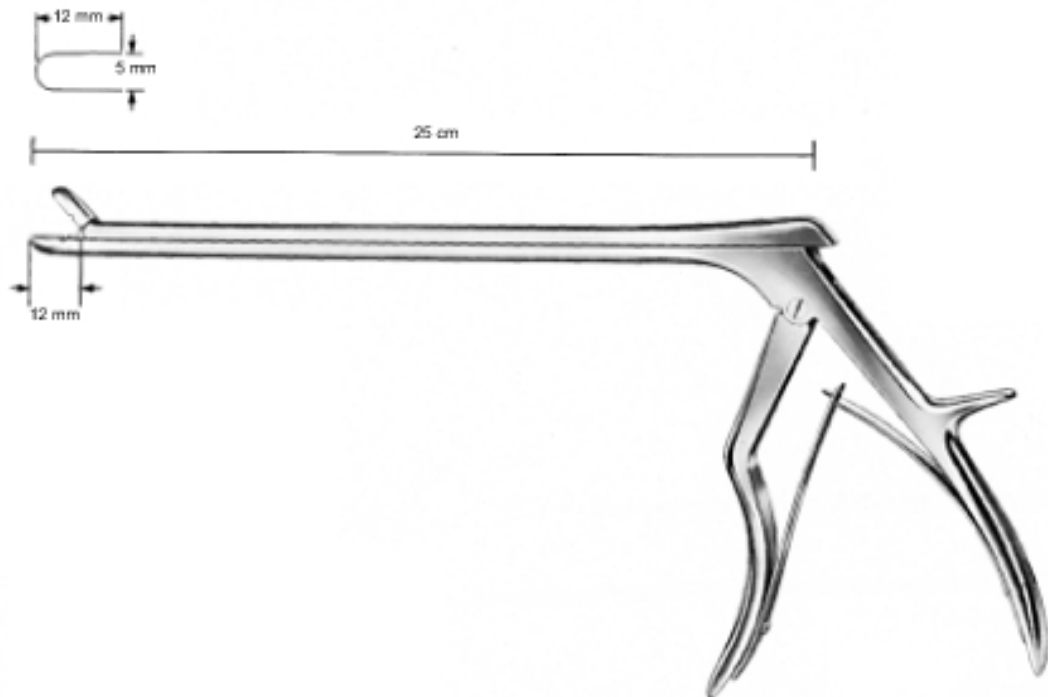

BEAUJEAN-ROOS
55.1004.25



Anaesthesia



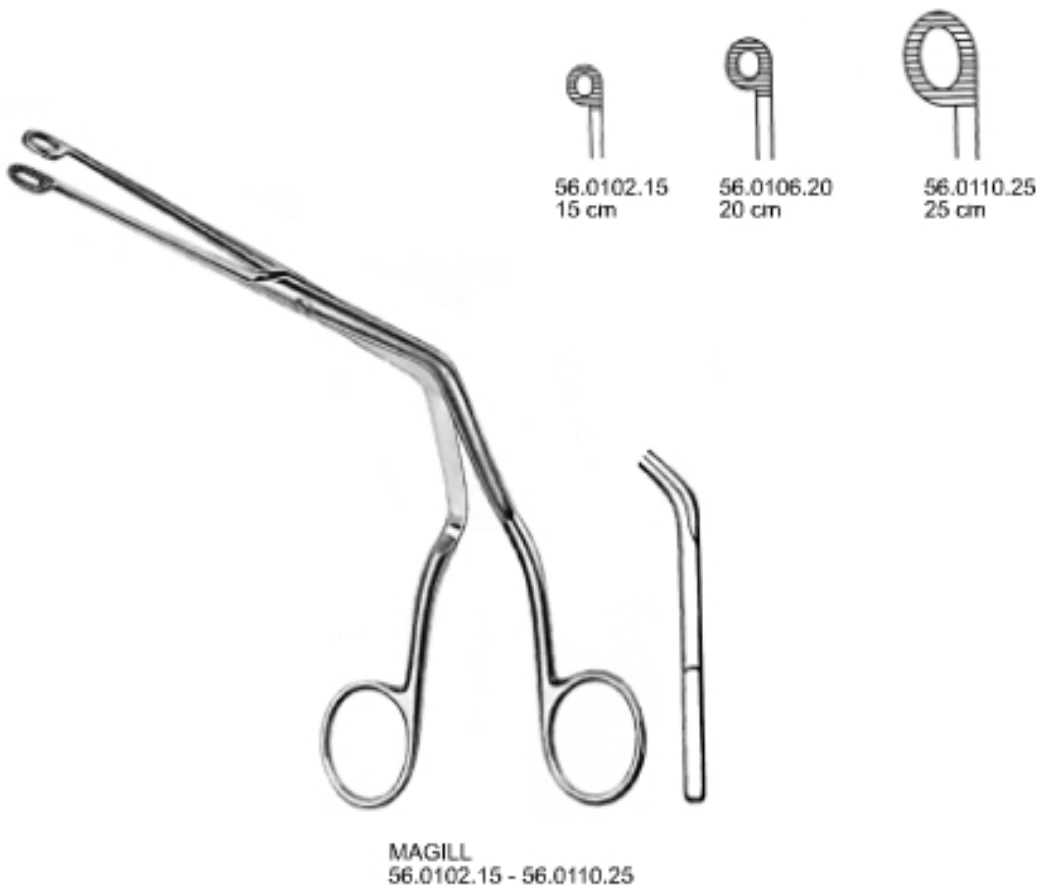

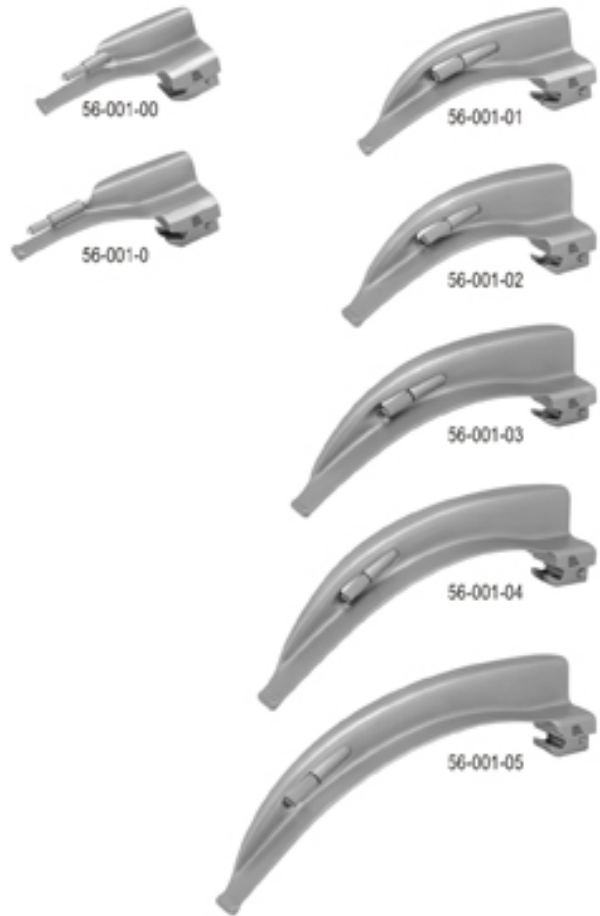

MACINTOSH - English Profile

Product Code	Size	Description	Overall Length (mm)	Distal Width (mm)
56-001-00	00	Premature	65	14
56-001-0	0	Neonate	80	14
56-001-01	1	Infant	92	14
56-001-02	2	Child	100	17
56-001-03	3	Medium Adult	130	18
56-001-04	4	Large Adult	155	18
56-001-05	5	X-Large Adult	175	24

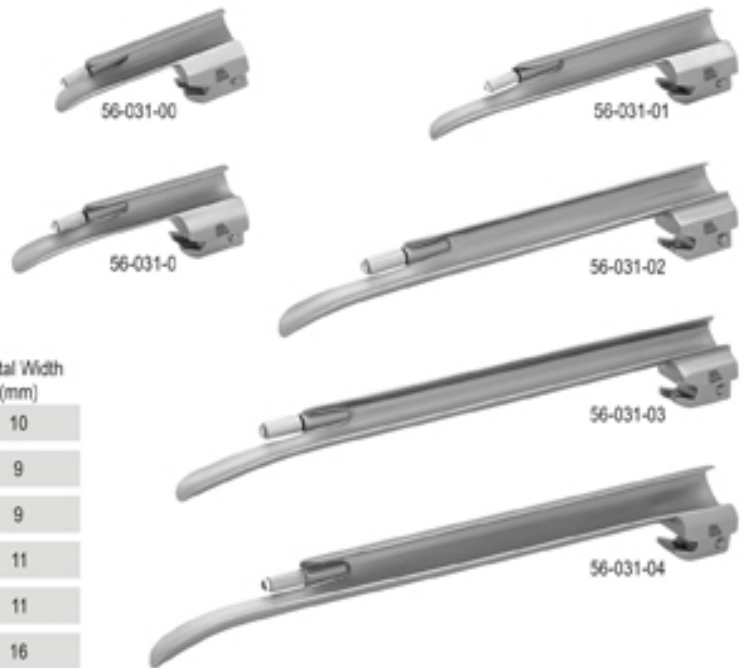

MILLER - English Profile

Product Code	Size	Description	Overall Length (mm)	Distal Width (mm)
56-031-00	00	Premature	65	10
56-031-0	0	Neonate	77	9
56-031-01	1	Infant	102	9
56-031-02	2	Child	153	11
56-031-03	3	Medium Adult	195	11
56-031-04	4	Large Adult	205	16

Laryngoscopes, Conventional
Laryngoskope, Konventionelle
Laringoscopios, Convencionales

NEAGUS - GUEDEL

Product Code	Size	Description	Overall Length (mm)	Distal Width (mm)
56-241-01	1	Infant	100	13
56-241-02	2	Child	115	13
56-241-03	3	Medium Adult	130	16
56-241-04	4	Large Adult	150	17

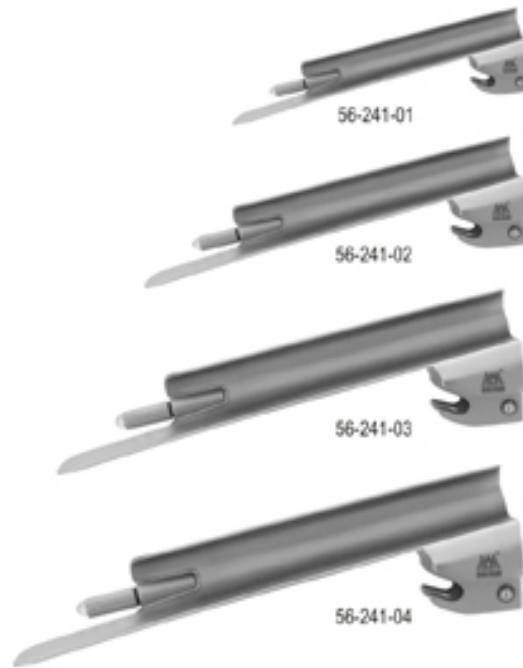

CHROME PLATED - BRASS

Product Code	Description	Overall Length (mm)	Batteries
56-701-01	Pediatric	155	2 "AA"
56-701-02	Medium	150	2 "C"
56-701-03	Large	175	2 "D"
56-701-04	Stubby	125	2 "AA"
56-701-06	Micro	120	Lithium "123"
56-701-05	Infant	90	Lithium "123"

STAINLESS STEEL

Product Code	Description	Overall Length (mm)	Batteries
56-702-01	Pediatric	155	2 "AA"
56-702-02	Medium	150	2 "C"
56-702-03	Large	175	2 "D"
56-702-04	Stubby	125	2 "AA"
56-702-06	Micro	120	Lithium "123"
56-702-05	Infant	90	Lithium "123"



MACINTOSH LARYNGOSCOPE SET - English Profile

Product Code	Description
56-801-01	1 Medium Handle, 4 Macintosh Blades (1,2,3,4), 2 Spare Lamps, 2 "C" Batteries
56-801-02	1 Medium Handle, 5 Macintosh Blades (0,1,2,3,4), 2 Spare Lamps, 2 "C" Batteries
56-801-03	1 Medium Handle, 6 Macintosh Blades (0,1,2,3,4,5), 2 Spare Lamps, 2 "C" Batteries



MILLER LARYNGOSCOPE SET - English Profile

Product Code	Description
56-803-01	1 Medium Handle, 4 Miller Blades (1,2,3,4), 2 Spare Lamps, 2 "C" Batteries
56-803-02	1 Medium Handle, 5 Miller Blades (0,1,2,3,4), 2 Spare Lamps, 2 "C" Batteries
56-803-03	1 Medium Handle, 6 Miller Blades (00,0,1,2,3,4), 2 Spare Lamps, 2 "C" Batteries



LAMPS - Conventional

Product Code	Size	Description	Voltage
56-901-01	Small	Clear	2.5 V
56-901-02	Large	Clear	2.5 V
56-901-03	Small	Frosted	2.5 V
56-901-04	Large	Frosted	2.5 V



57-001-00



57-001-01



57-001-0



57-001-02



57-001-03



57-001-04



57-001-05

MACINTOSH - English Profile

Product Code	Size	Description	Overall Length (mm)	Distal Width (mm)
57-001-00	00	Premature	65	15
57-001-0	0	Neonate	80	17
57-001-01	1	Infant	92	14
57-001-02	2	Child	100	17
57-001-03	3	Medium Adult	130	18
57-001-04	4	Large Adult	155	18
57-001-05	5	X-Large Adult	175	24



57-051-00



57-051-01



57-051-0



57-051-02



57-051-03



57-051-04

MILLER - English Profile

Product Code	Size	Description	Overall Length (mm)	Distal Width (mm)
57-051-00	00	Premature	65	8
57-051-0	0	Neonate	77	9
57-051-01	1	Infant	102	9
57-051-02	2	Child	153	11
57-051-03	3	Medium Adult	195	11
57-051-04	4	Large Adult	205	16



MACINTOSH LARYNGOSCOPE SET - English Profile

Product Code	Description
57-801-01	1 Medium Handle, 4 Macintosh Blades (1,2,3,4), 2 Spare Lamps, 2 "C" Batteries
57-801-02	1 Medium Handle, 5 Macintosh Blades (0,1,2,3,4), 2 Spare Lamps, 2 "C" Batteries
57-801-03	1 Medium Handle, 6 Macintosh Blades (0,1,2,3,4,5), 2 Spare Lamps, 2 "C" Batteries



MILLER LARYNGOSCOPE SET - English Profile

Product Code	Description
57-803-01	1 Medium Handle, 4 Miller Blades (1,2,3,4), 2 Spare Lamps, 2 "C" Batteries
57-803-02	1 Medium Handle, 5 Miller Blades (0,1,2,3,4), 2 Spare Lamps, 2 "C" Batteries
57-803-03	1 Medium Handle, 6 Miller Blades (00,0,1,2,3,4), 2 Spare Lamps, 2 "C" Batteries

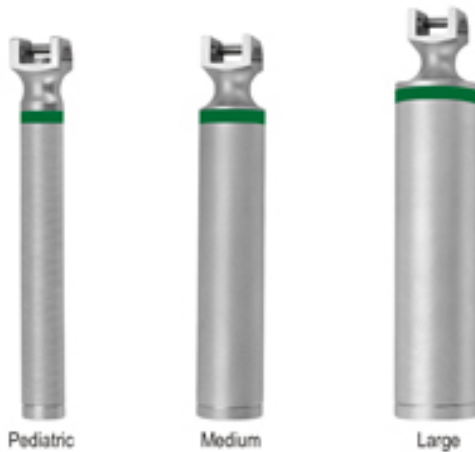

CHROME PLATED - BRASS

Product Code	Description	Overall Length (mm)	Batteries
57-701-01	Pediatric	160	2 "AA"
57-701-02	Medium	160	2 "C"
57-701-03	Large	175	2 "D"
57-701-04	Stubby	125	2 "AA"
57-701-05	Infant	90	Lithium "123"
57-701-06	Micro	122	Lithium "123"



STAINLESS STEEL

Product Code	Description	Overall Length (mm)	Batteries
57-702-01	Pediatric	160	2 "AA"
57-702-02	Medium	160	2 "C"
57-702-03	Large	175	2 "D"
57-702-04	Stubby	125	2 "AA"
57-702-05	Infant	90	Lithium "123"
57-702-06	Micro	122	Lithium "123"



Bone Surgery





26 mm \varnothing

MEAD
57.0102.17
17 cm
(26.009.17)



57.0106.01
26 mm \varnothing
(26.005.02)



57.0110.02
28 mm \varnothing
(26.006.02)



57.0114.03
30 mm \varnothing
(26.007.03)



WILLINGER
57.0106.01 - 57.0114.03



LEAD FILLED
57.0122.16
16.5 cm
(26.008.16)

57

Bone Rongeur Forceps
Hohlmeißelzangen
Pinzas Gubias



MINI-FRIEDMAN
57.0127.12
12 cm
(14.004.12)



FRIEDMAN
57.0131.14
14 cm
(14.002.14)



CLEVELAND
57.0135.14
14 cm
(14.003.14)



CLEVELAND
57.0139.17
17 cm
(14.001.17)



UNIVERSAL
57.0143.13
13.5 cm
(14.008.13)



MEAD
57.0147.16
16.5 cm
(14.006.16)



HARTMANN
57.0151.18
18.5 cm
(14.005.18)

Bone Rongeur Forceps
Hohlmeißelzangen
Pinzas Gubias

57



BLUMENTHAL
57.0155.15
15.5 cm
(14.014.15)



BLUMENTHAL
57.0159.15
15.5 cm
(14.015.15)



BLUMENTHAL
57.0163.15
15.5 cm
(14.011.15)



57.0167.15
(14.012.00)

57.0169.15
(14.013.00)

LUER
57.0167.15-57.0169.15
15 cm



LUER
57.0171.15
15 cm
(14.009.15)



BEYER
57.0175.18
18 cm
(14.021.18)

57

Bone Rongeur Forceps
Hohlmeißelzangen
Pinzas Gubias



BLUMENTHAL-S
57.0191.00
15 cm
(14.094.15)



BLUMENTHAL
57.0195.16
16.5 cm
(14.095.16)



HARTMANN
57.0199.18
18 cm
(14.096.18)



BLUMENTHAL
57.0203.16
16 cm
(14.097.16)



BLUMENTHAL
57.0207.15
15 cm
(14.098.15)



BLUMENTHAL
57.0211.15
15 cm
(14.099.15)

Bone Rongeur Forceps
Hohlmeißelzangen
Pinzas Gubias

57



CLEVELAND 3
57.0215.14
14 cm
(14.073.14)



CLEVELAND 4
57.0219.15
15 cm
(14.074.15)



CLEVELAND 4A
57.0223.17
17 cm
(14.072.17)



CLEVELAND 5
57.0227.17
17 cm
(14.077.17)



CLEVELAND 5S
57.0231.15
15 cm
(14.076.15)



CLEVELAND 10
57.0235.17
17 cm
(14.075.17)

57

Bone Rongeur Forceps
Hohlmeißelzangen
Pinzas Gubias

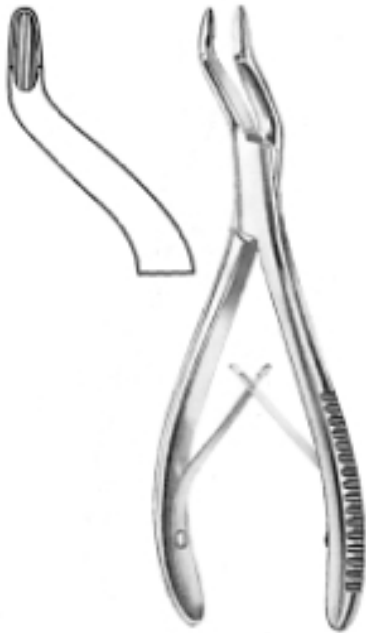

57.0239.00
(14.083.00)



57.0243.13
13.5 cm
(14.079.00)



BANE
57.0245.17
17 cm
(14.080.17)



JANSEN
57.0249.00
(14.081.00)



JANSEN
57.0253.00
(14.082.00)



ADSON
57.0256.20
20 cm
(14.078.20)

Bone Rongeur, Bone Cutting Forceps
 Hohlmeißel, Knochen Splitter Zangen
 Pinzas Gubias, cou pantes



CLEVELAND
 57.0260.17
 17 cm
 (14.018.17)



CLEVELAND-GARDNER
 57.0265.17
 17 cm
 (14.088.17)



CLEVELAND-GARDNER
 57.0269.16
 16 cm
 (14.089.16)



57.0273.1
 17.5 cm
 (14.084.17)



57.0277.1
 14 cm
 (14.085.14)



57.0281.1
 17.5 cm
 (14.086.17)

57

Bone Rongeur Forceps
Hohlmeißelzangen
Pinzas Gubias



RUSKIN
57.0291.18
18 cm
(14.090.18)



BEYER
51.0295.18
18 cm
(14.092.18)

Bone Rongeur Forceps
Hohlmeißelzangen
Pinzas Gubias

57



MAYFIELD
57.0299.17
17 cm



ZAUFAL-JANSEN
57.0303.18
18 cm



ECHLIN
57.0306.02 - 57.0314.04
23 cm



STILLE
57.0318.23
23 cm



STILLE-LUER
57.0322.22 - 57.0323.22
22 cm

57

Bone Cutting Forceps
Knochensplitterzangen
Pincès coupantes

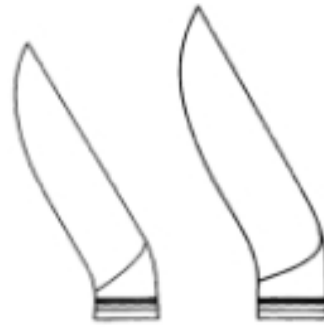

57.0331.23
23 cm

57.0335.27
27 cm



STILLE-LISTON
57.0327.27
27 cm



STILLE-LISTON
57.0331.23 - 57.0335.27

Bone Cutting Forceps
Knochensplitterzangen
Pincès coupantes

57



LISTON
57.0340.14 - 57.0952.22



57.0340.14 14 cm



57.0344.17 17 cm



57.0348.19 19 cm
57.0352.22 22 cm



LISTON
57.0355.14 14 cm
57.0359.17 17 cm
57.0363.19 19 cm
57.0367.22 22 cm

57

Bone Cutting Forceps
Knochensplitterzangen
Pincès coupantes



LISTON-KEY-HORSLEY
57.0371.26
26.5 cm



LISTON-STILLE
57.0376.26
26 cm

Bone Cutting Forceps
 Knochensplitterzangen
 Pinces coupantes

57

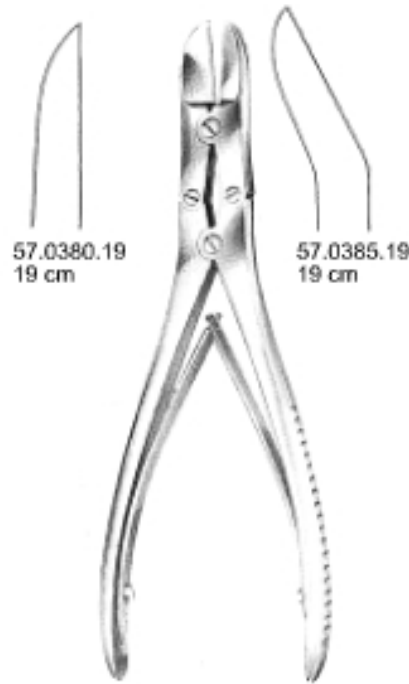

RUSKIN-LISTON
 57.0380.19 - 57.0385.19

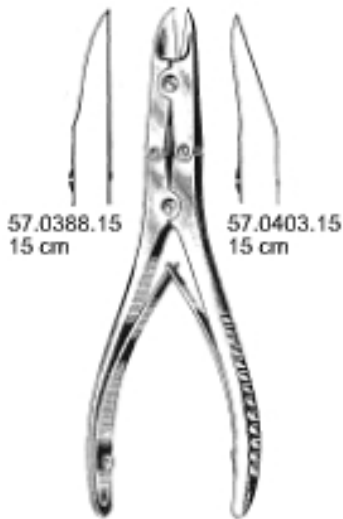

BOHLER
 57.0388.15 - 57.0403.15



McINDOE
 57.0408.17
 17 cm

57

Bone Holding Forceps
Knochenhaltezzangen
Pinzas Para Huesos



57.0411.13
13.5 cm



KERN
57.0416.17 - 57.0420.21



57.0416.17
17 cm

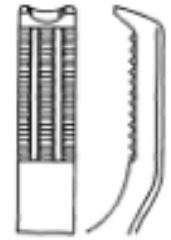

57.0420.21
21 cm



57.0424.16 - 57.0428.24



57.0424.16
16 cm

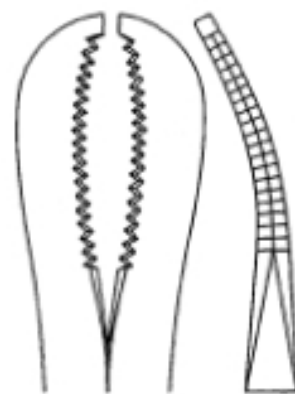

57.0428.24
24 cm



57.0433.14
13.5 cm

Bone Holding Forceps
Knochenhaltezaugen
Pinzas Para Huesos

57



LAMBOTTE
57.0438.22 22 cm
57.0442.27 27 cm
57.0446.30 30 cm



ULRICH
57.0450.23 23 cm
57.0454.25 25 cm
57.0458.28 28 cm

57

Bone Holding Forceps
Knochenhaltezaugen
Pinzas Para Huesos



57.0462.16
16 cm



57.0466.17 - 57.0470.17
17 cm



57.0466.17



57.0470.17



57.0474.19
19 cm



Wire Cutting Pliers with Tungsten Carbide Inserts
 Drahtschneide Zangen mit Hartmetalleinsätzen
 Pincès Pour Couper les Fils Métalliques de carbure de Tungstène

57

TC GOLD

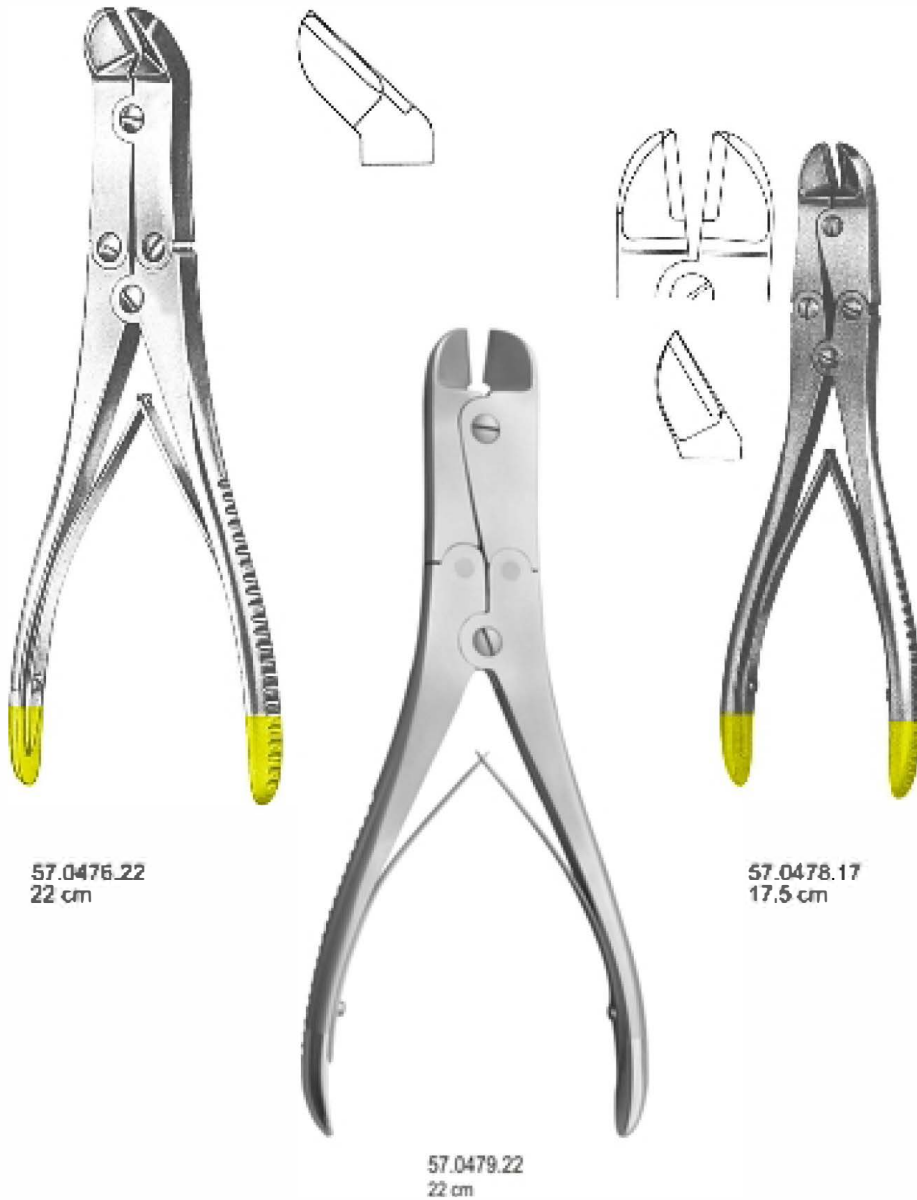

57

Front Cutting Action, Wire Cutting Pliers with Tungsten Carbide Inserts
Kopfschneider, Drahtschneide Zangen mit Hartmetalleinsätzen
Tranchant Frontal, Pinces Pour Couperdes Filş Metalliques de carburo de Tungsteno

TC GOLD



57.0480.47
47 cm



57.0482.22
22 cm

Bone Curettes
Scharfe Löffel
Cucharillas Cortantes

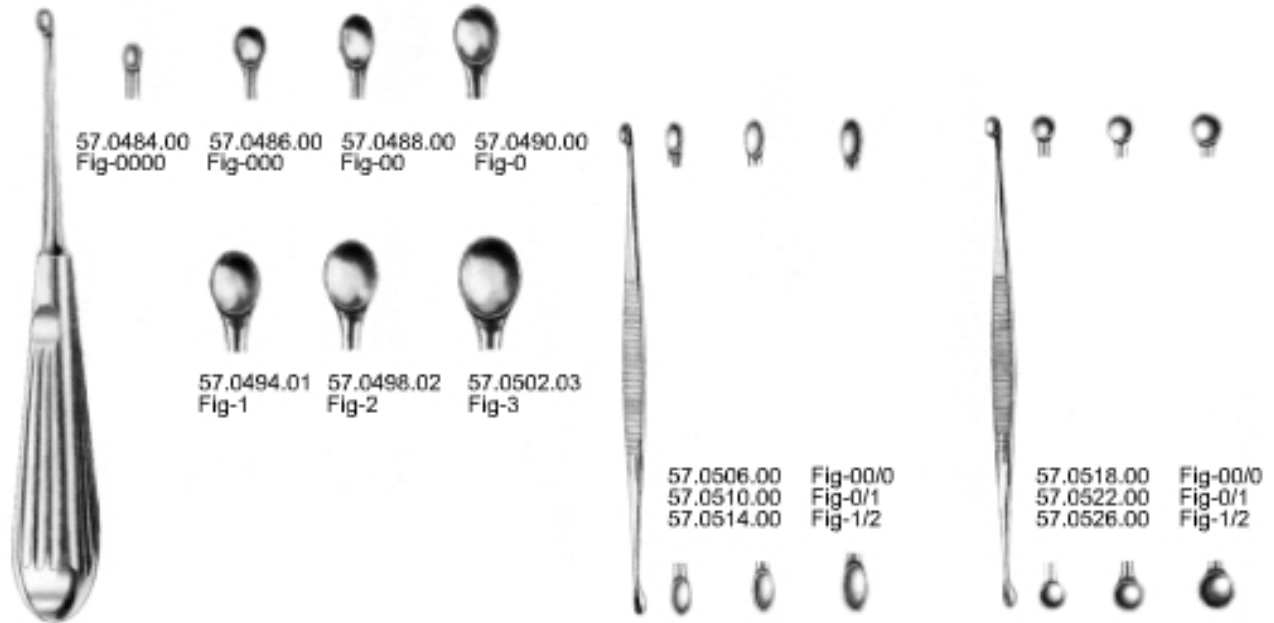

VOLKMANN
57.0484.00 - 57.0502.03
17 cm
(12.014.17)

WILLIGER
57.0506.00 - 57.0514.00
14 cm
(12.011.14)

MARTINI
57.0518.00 - 57.0526.00
14 cm
(12.012.14)

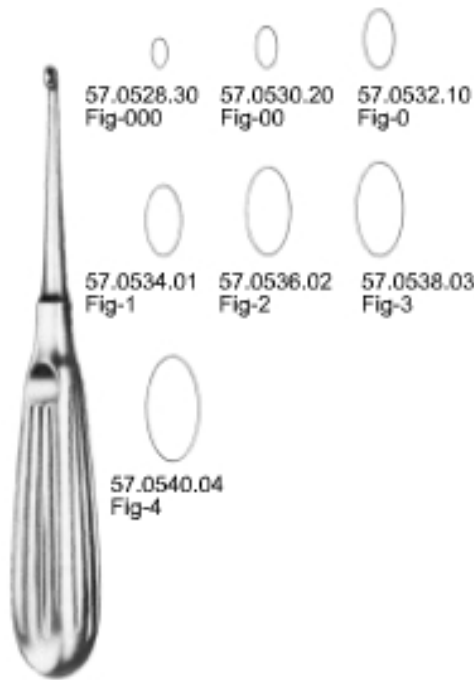

SCHEDE
57.0528.30 - 57.0540.04

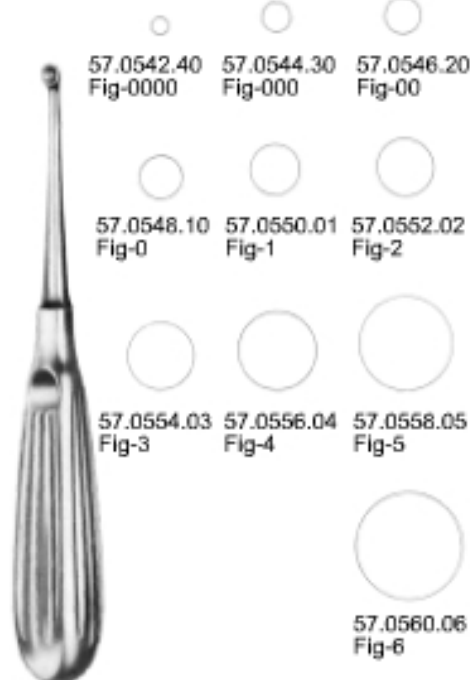

BRUNS
57.0542.40 - 57.0560.06



HALLE
57.0562.01 - 57.0566.03
21 cm

Bone Chisel and Gouges
Meißel und Oseotome
Cinceles Y Gubias para Huesos

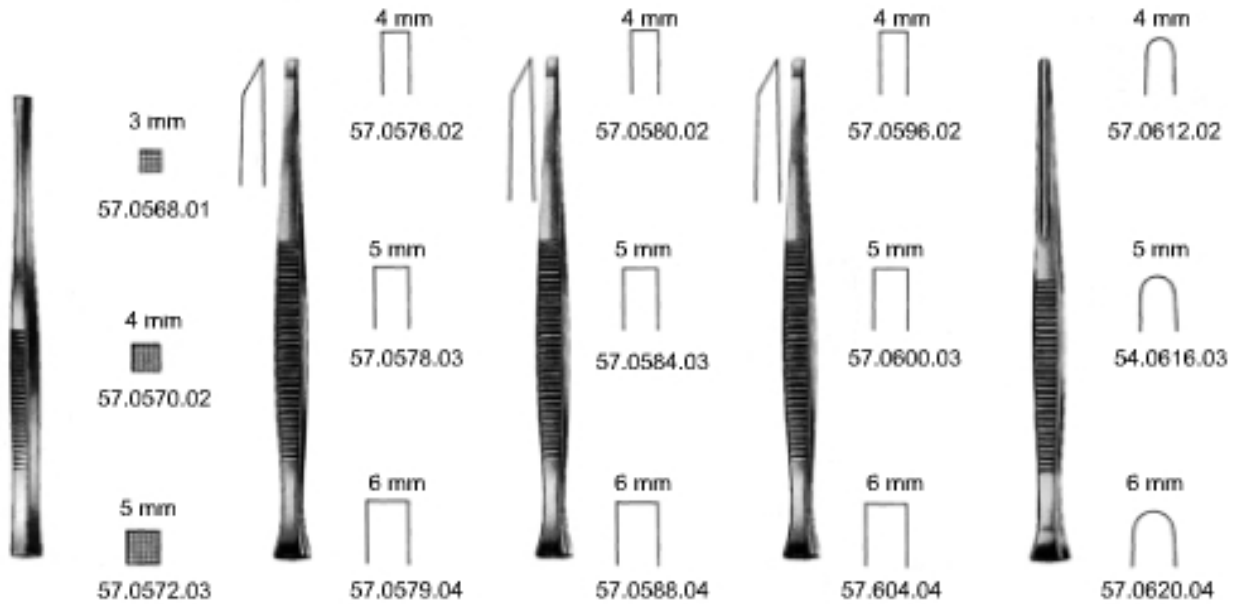

PASSOW
57.0568.01 - 57.0572.03
12 cm

PARTSCH
57.0574.01 - 57.0579.04
(03.071.13)
11.5 cm

PARTSCH
57.0580.01 - 57.0588.04
(03.072.13)
13.5 cm

PARTSCH
57.0592.01 - 57.0604.04
(03.073.17)
17 cm

PARTSCH
57.0608.01 - 57.0620.04
(03.074.17)
17 cm

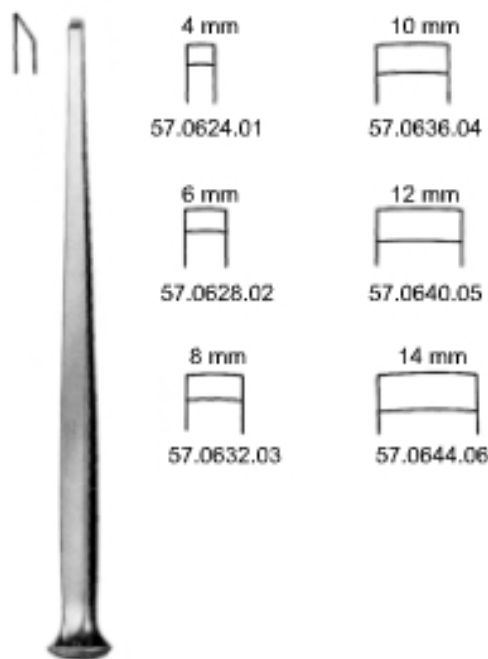

ALEXANDER
57.0624.01 - 57.0644.06
18 cm

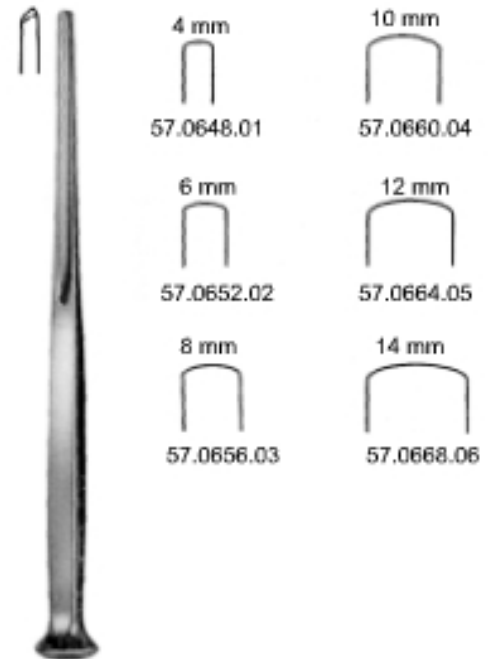

ALEXANDER
57.0648.01 - 57.0668.06
18 cm

Bone Chisel and Gouges
 Meißel und Oseotome
 Cinceles Y Gubias para Huesos

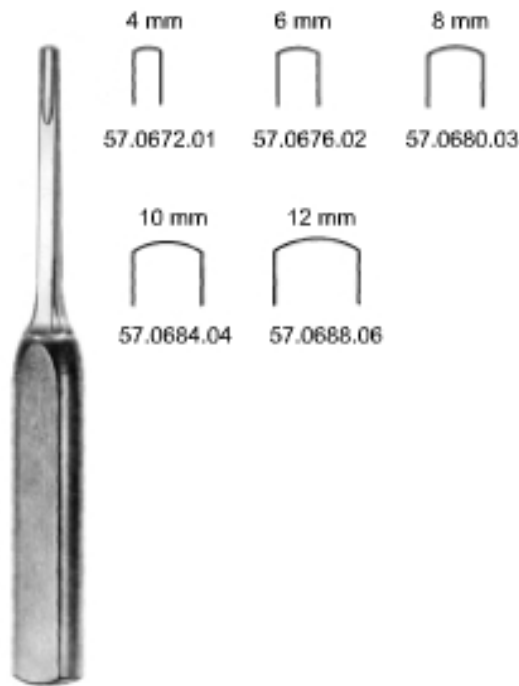

MINI-LEXER
 57.0672.01 - 57.0688.05
 18 cm



FARABEUF
 57.0692.15
 15 cm



FARABEUF
 57.0696.15
 15 cm

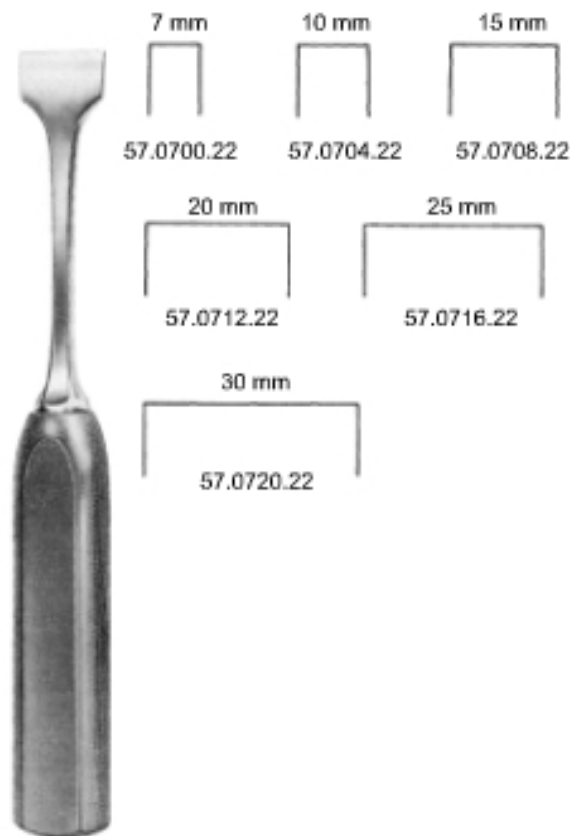

LEXER
 57.0700.22 - 57.0720.22
 22 cm

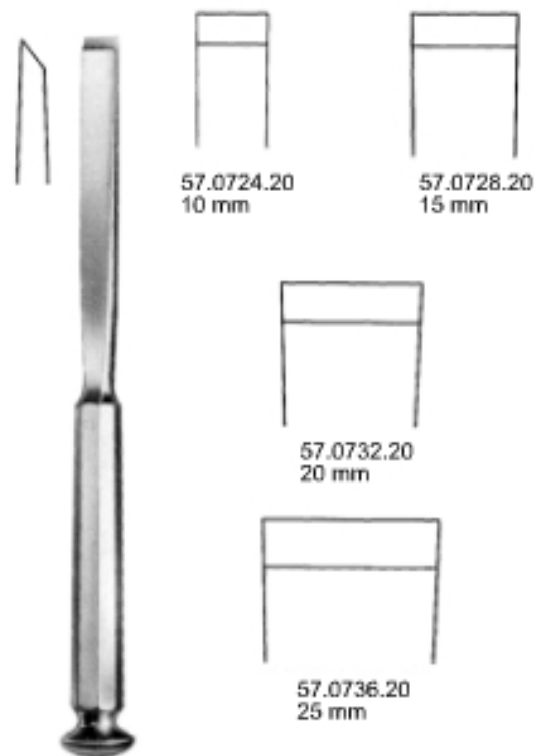

STILLE
 57.0724.20 - 57.0736.20
 20 cm

57

Bone Chisel and Gouges
 Meißel und Oseotome
 Cinceles Y Gubias para Huesos

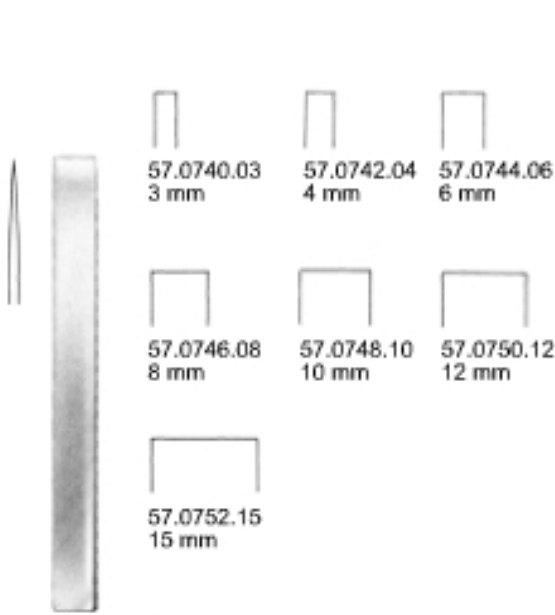

MINI-LAMBOTTE
 57.0740.03 - 57.0752.15
 12.5 cm

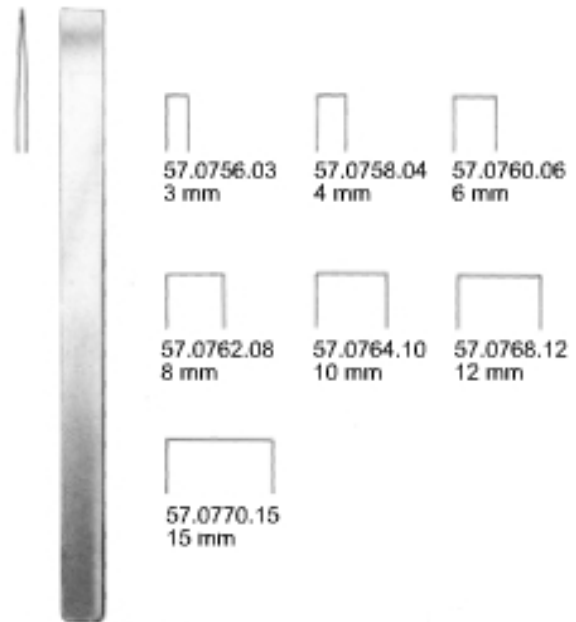

MINI-LAMBOTTE
 57.0756.03 - 57.0770.15
 17 cm

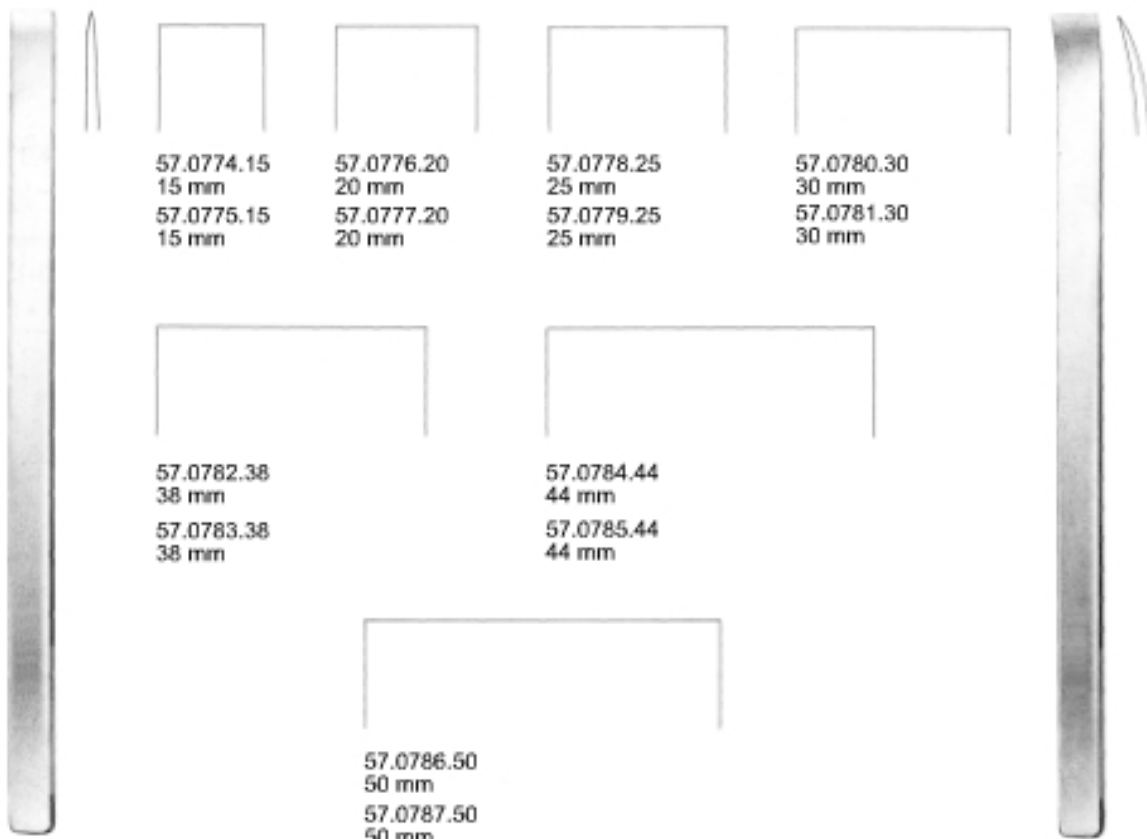























LAMBOTTE
 57.0774.15 - 57.0786.50
 24 cm

LAMBOTTE
 57.0775.15 - 57.0787.50
 24 cm

Bone Chisel and Gouges
 Meißel und Oseotome
 Cinceles Y Gubias para Huesos

57

			
57.0792.06 6 mm	57.0807.06 6 mm		
			
57.0794.09 9 mm	57.0809.09 9 mm		
			
57.0796.13 13 mm	57.0811.13 13 mm		
			
57.0798.16 16 mm	57.0815.16 16 mm	57.0826.09 09 mm	57.0835.09 09 mm
			
57.0800.19 19 mm	57.0817.19 19 mm	57.0828.14 14 mm	57.0837.14 14 mm
			
57.0802.25 25 mm	57.0819.25 25 mm	57.0830.19 19 mm	57.0839.19 19 mm
			
57.0804.32 32 mm	57.0821.32 32 mm	57.0832.25 25 mm	57.0841.25 25 mm
SMITH-PETERSEN 57.0792.06 - 57.0804.32 20 cm	SMITH-PETERSEN 57.0807.06 - 57.0821.32 20 cm	SMITH-PETERSEN 57.0826.09 - 57.0832.25 20 cm	SMITH-PETERSEN 57.0835.09 - 57.0841.25 20 cm



Mini - Lexer
 18 cm
 57.0844.04 4mm
 57.0846.06 6mm
 57.0848.08 8mm
 57.0852.10 10mm
 57.0856.12 12mm
 57.0860.15 15mm



Lexer
 22 cm
 57.0864.05 5mm
 57.0868.07 7mm
 57.0872.10 10mm
 57.0876.15 15mm
 57.0880.20 20mm
 57.0884.25 25mm
 57.0888.30 30mm



Osteotom
 20 cm



57.0892.10	10mm	57.0907.10	10mm
57.0896.15	15mm	57.0911.15	15mm
57.0902.20	20mm	57.0913.20	20mm



Mini - Lexer
 18 cm
 57.0918.04 4mm
 57.0922.06 6mm
 57.0926.08 8mm
 57.0930.10 10mm
 57.0934.12 12mm
 57.0938.15 15mm



Mini - Lexer
 18 cm
 57.0942.04 4mm
 57.0946.06 6mm
 57.0950.08 8mm
 57.0954.10 10mm
 57.0958.12 12mm
 57.0962.15 15mm

57

Bone Curettes
Scharfe Laffel
Cucharillas Cortantes

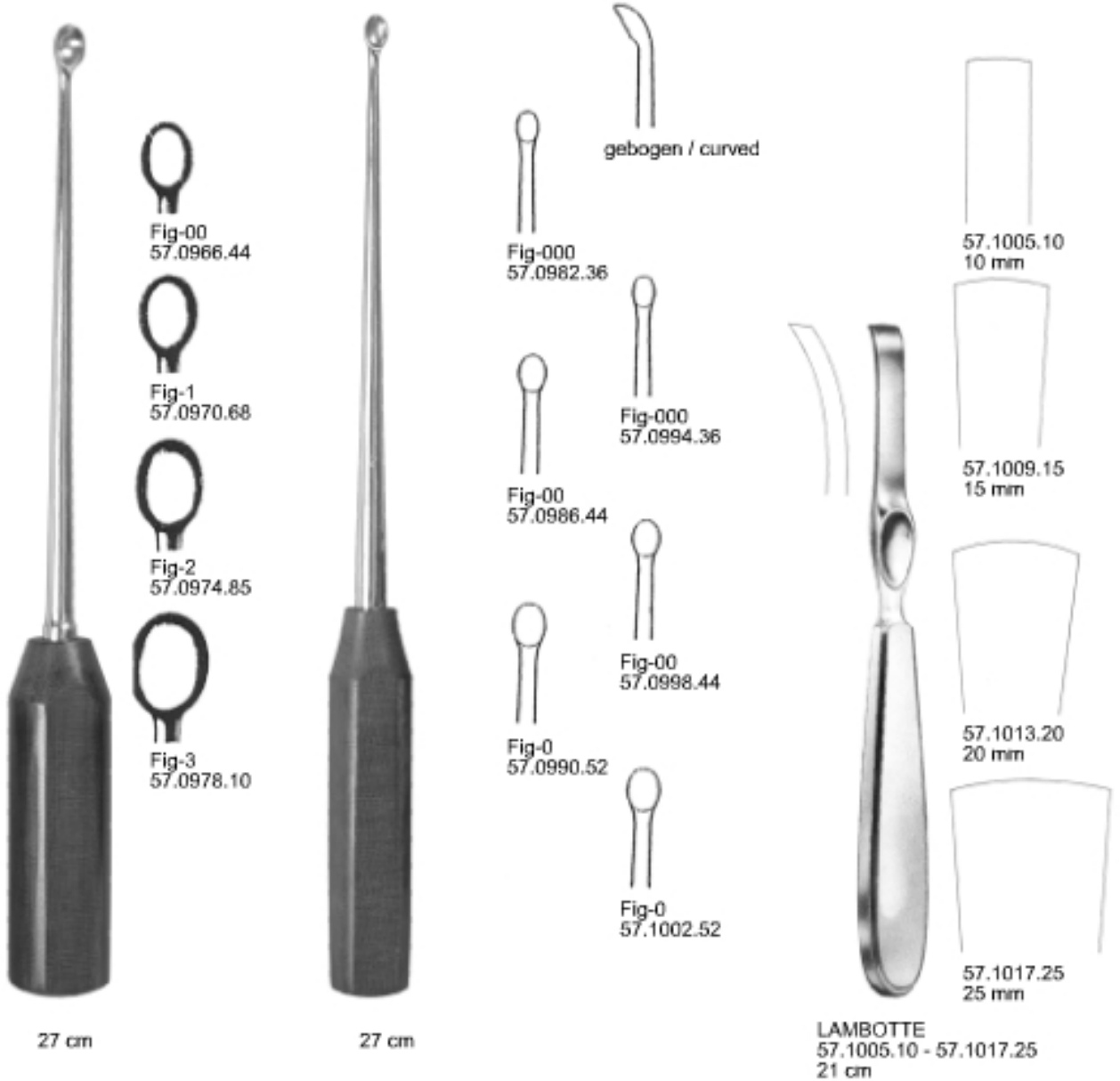

Periosteal Raspatories
Raspatorien
Legras-Periostotomos

57

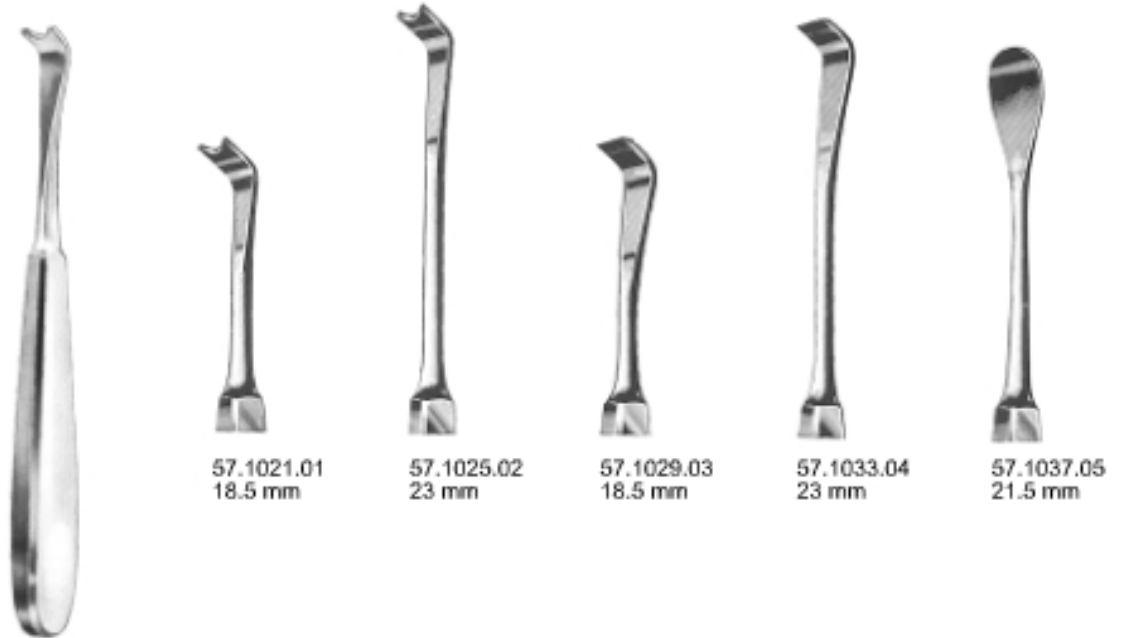

SEMB
51.1021.01 - 51.1033.04

Periosteal Raspatories - Raspatorien - Legras-Periostotomos

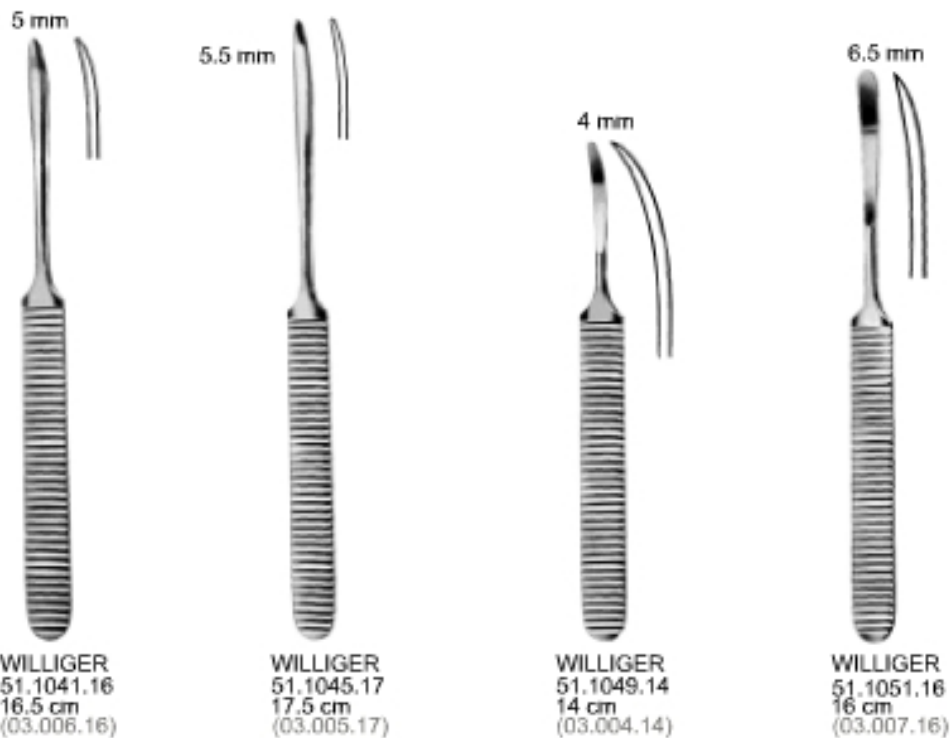

WILLIGER
51.1041.16
16.5 cm
(03.006.16)

WILLIGER
51.1045.17
17.5 cm
(03.005.17)

WILLIGER
51.1049.14
14 cm
(03.004.14)

WILLIGER
51.1051.16
16 cm
(03.007.16)

Bone Holding Forceps
Knochenhaltezangen
Pinzas Para Huesos

57



SEMBO
57.1100.19
19 cm



FERGUSSON
57.1104.21
21 cm



57.1108.20
20 cm



FARABEUF-LAMBOTTE
57.1112.26
26 cm

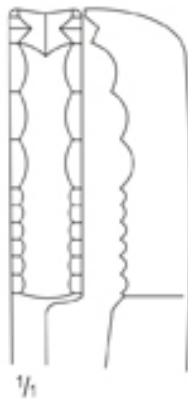

LOWMAN
57.1116.13 13.0 cm
57.1120.18 18.5 cm
57.1124.20 20.0 cm

57

Bone Holding Forceps
 Knochenhaltezaugen
 Pinzas Para Huesos



57.1128.15 - 57.1144.28

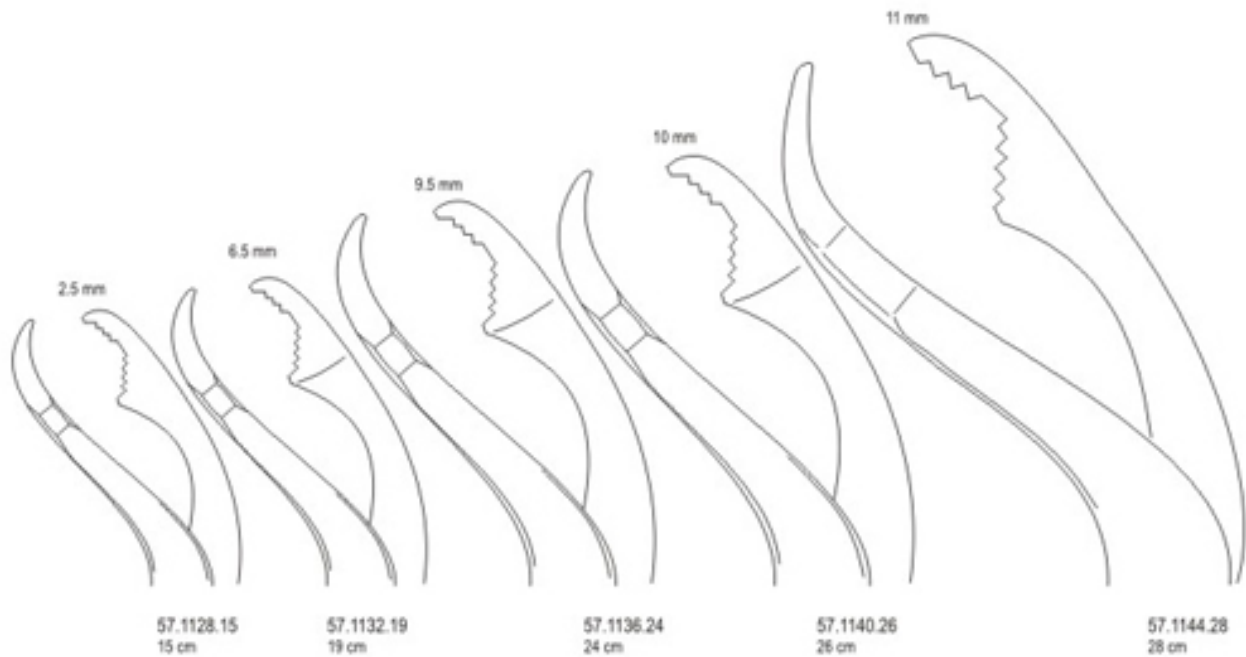

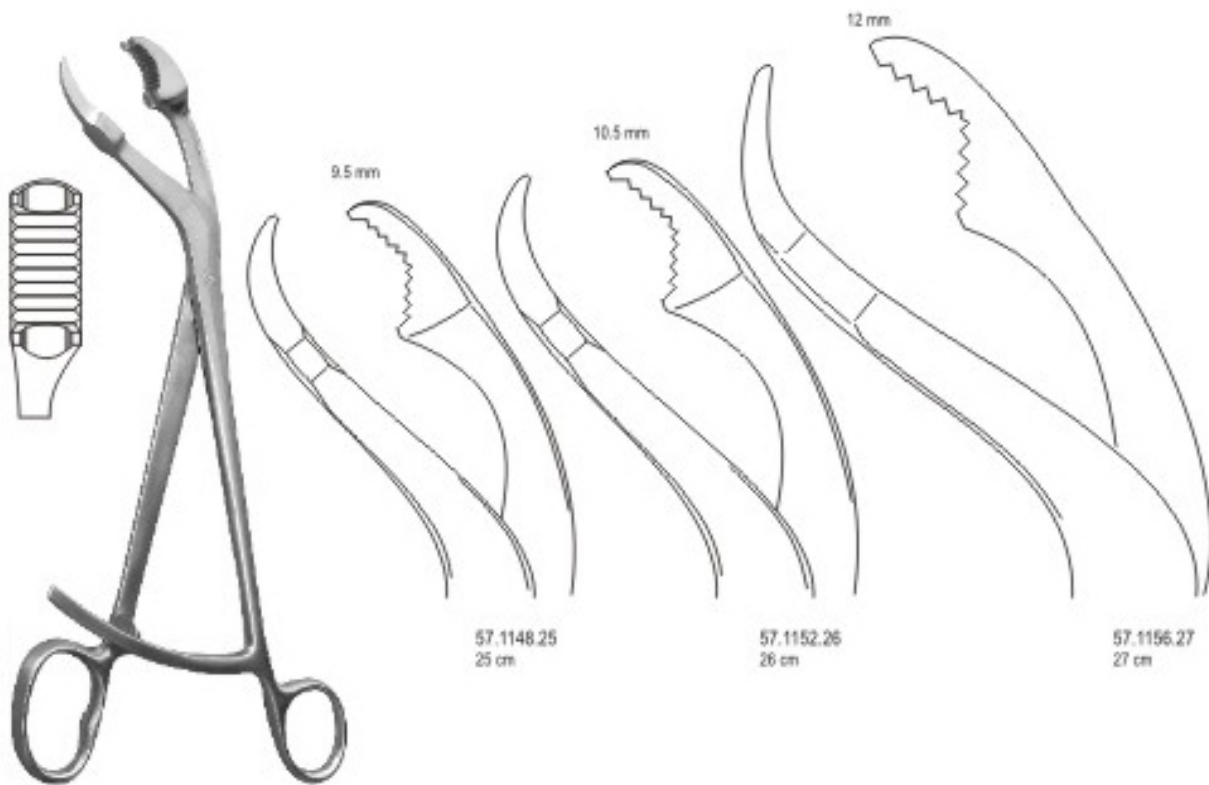

VERBRUGGE
57.1148.25 - 57.1156.27



Dressing



Plaster of Paris Shears
 Gipsscheren
 Cizallas para Vendajas Enyesados

58



STILLE-MOD
 58.0102.23 - 58.0110.37



58.0102.23
 23 cm



58.0106.26
 26 cm



58.0110.37
 37 cm

58

Plaster Cast Instruments
 Gipsspreizer, GipsabreilBzanGen
 Intrumentos para Yendajas Enyesados

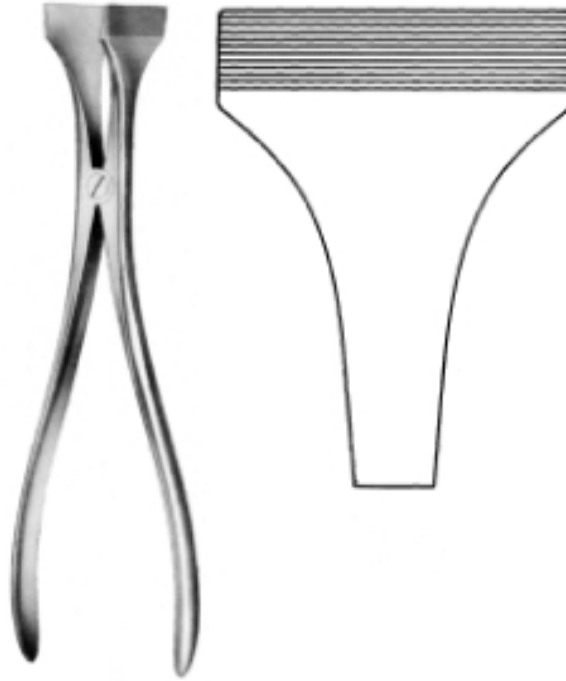

HENNING
 58.0114.28
 28 cm

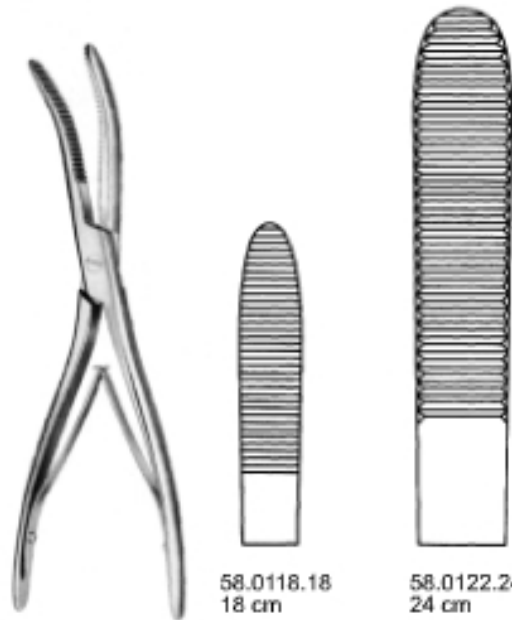

58.0118.18
 18 cm

58.0122.24
 24 cm

WOLF
 58.0118.18 - 58.0122.24



BRUNS
58.0125.24
24 cm

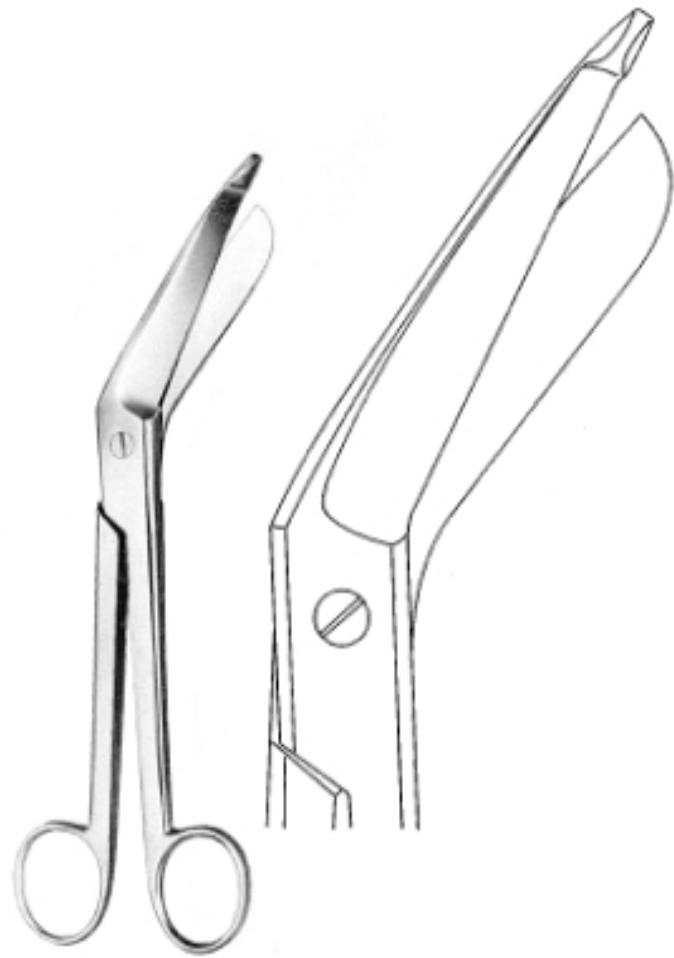

BERGMANN
58.0129.23
23 cm

58

Bandage Scissors
Verbandscheren
Tijeras Para Vendajes



LISTER (UNIVERSAL)
58.0133.15 15 cm
58.0137.18 18 cm (32, 135, 18)
(handle available in different colours)



LISTER (ROUND TYPE)
58.0141.18 18 cm
58.0145.20 20 cm

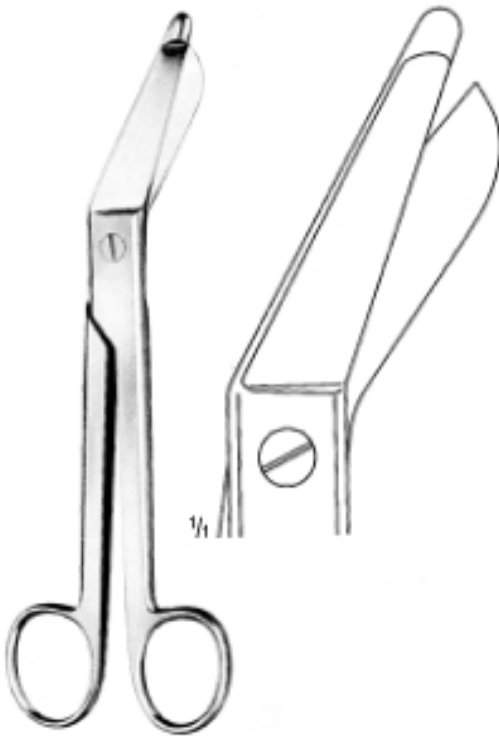

ESMARCH
58.0149.20
20 cm



LISTER
42.0379.14 14 cm (32, 131, 14)
42.0383.18 18 cm (32, 132, 18)
42.0387.20 20 cm

TC GOLD

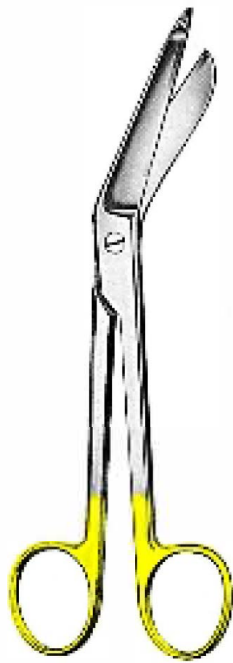

LISTER
 58.0153.18
 18 cm

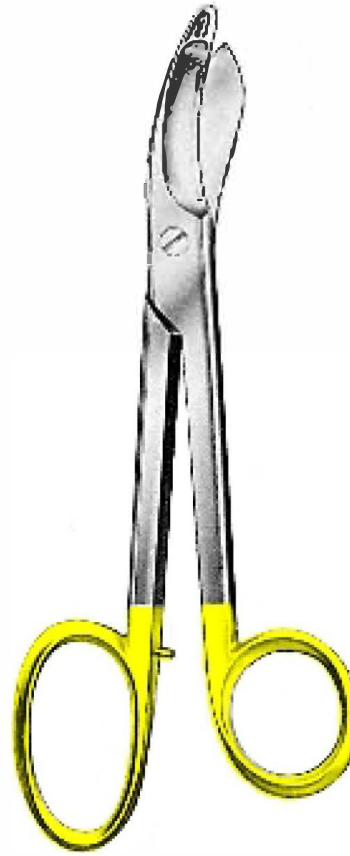
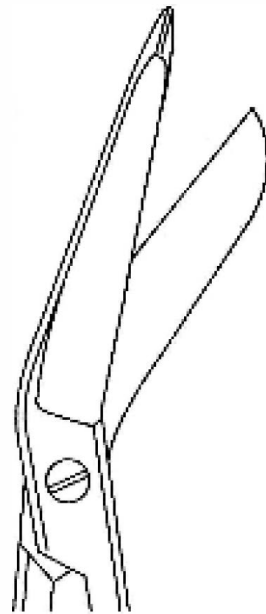

BRUNS
 58.0155.24
 24 cm

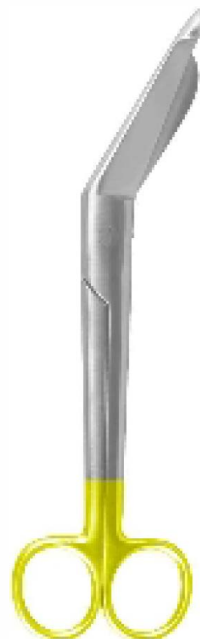
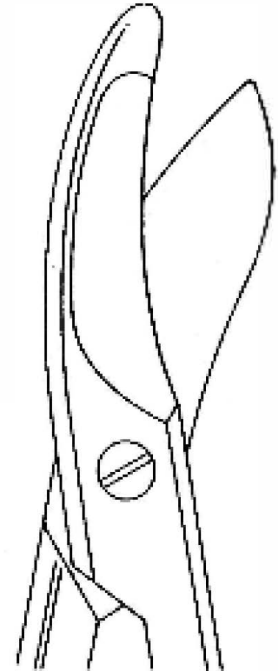

LISTER (ROUND TYPE)
 58.0159.18 18 cm
 58.0163.20 20 cm



Intestines, Stomach, Rectum



Tissue and Organ Holding Forceps
 Gewebe- und Organ-Fabzangen
 Pinzas Para Tejidos y Organos

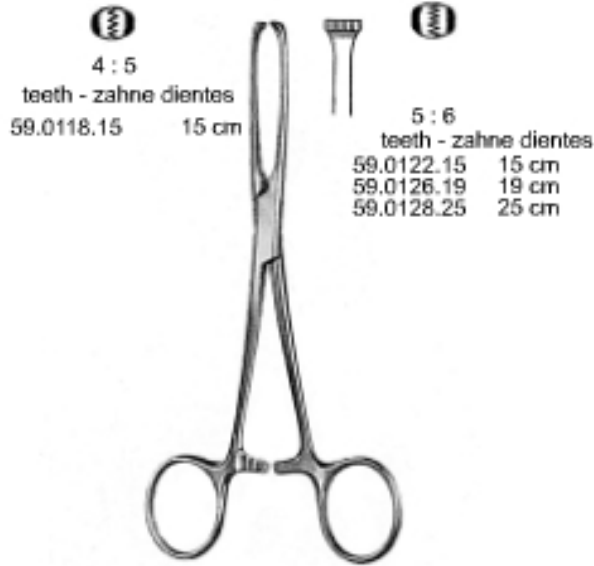

4 : 5
 teeth - zahne dientes
 59.0118.15 15 cm

5 : 6
 teeth - zahne dientes
 59.0122.15 15 cm
 59.0126.19 19 cm
 59.0128.25 25 cm

ALLIS
 59.0118.15 - 59.0128.25



ALLIS-BABY
 59.0130.12
 12 cm
 4 : 5 teeth - zahne - dientes



JUDD-ALLIS
 59.0134.15 15 cm
 59.0138.19 19 cm



ALLIS-ADAIR
 59.0140.15
 15 cm

59

Tissue and Organ Holding Forceps
Gewebe-und Organ-fabzangen
Pinzas Para Tejidos y Organos

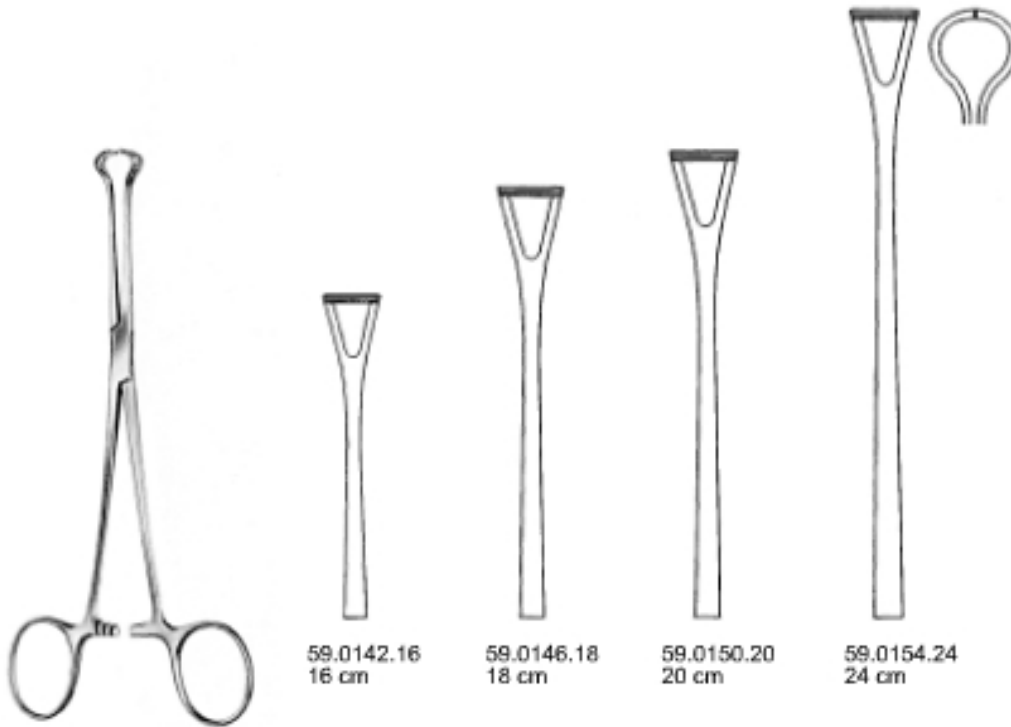

BABCOCK
59.0142.16 - 59.0154.24

59.0142.16
16 cm

59.0146.18
18 cm

59.0150.20
20 cm

59.0154.24
24 cm

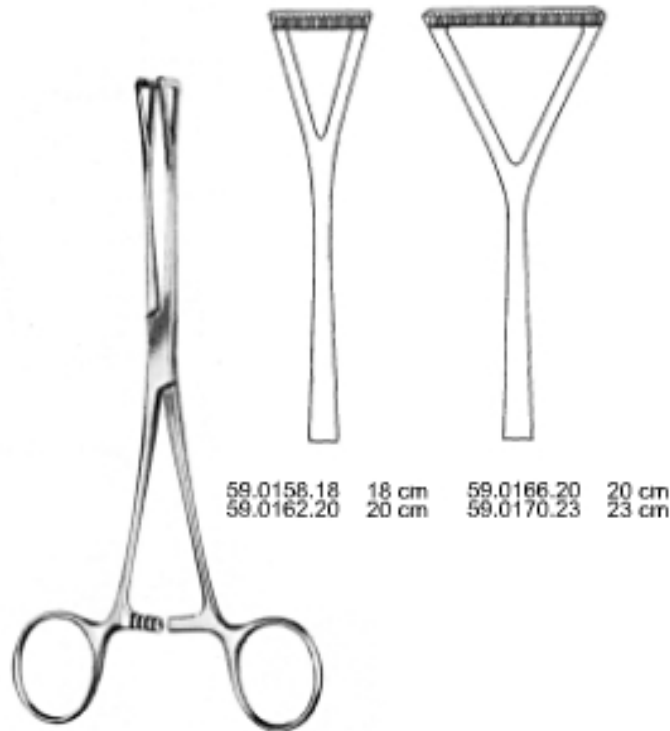

DUVAL
59.0158.18 - 59.0170.23

59.0158.18 18 cm
59.0162.20 20 cm

59.0166.20 20 cm
59.0170.23 23 cm

Intestinal Clamp Forceps
 Darmklemmen
 Pinzas-Clamps Intestinales

59

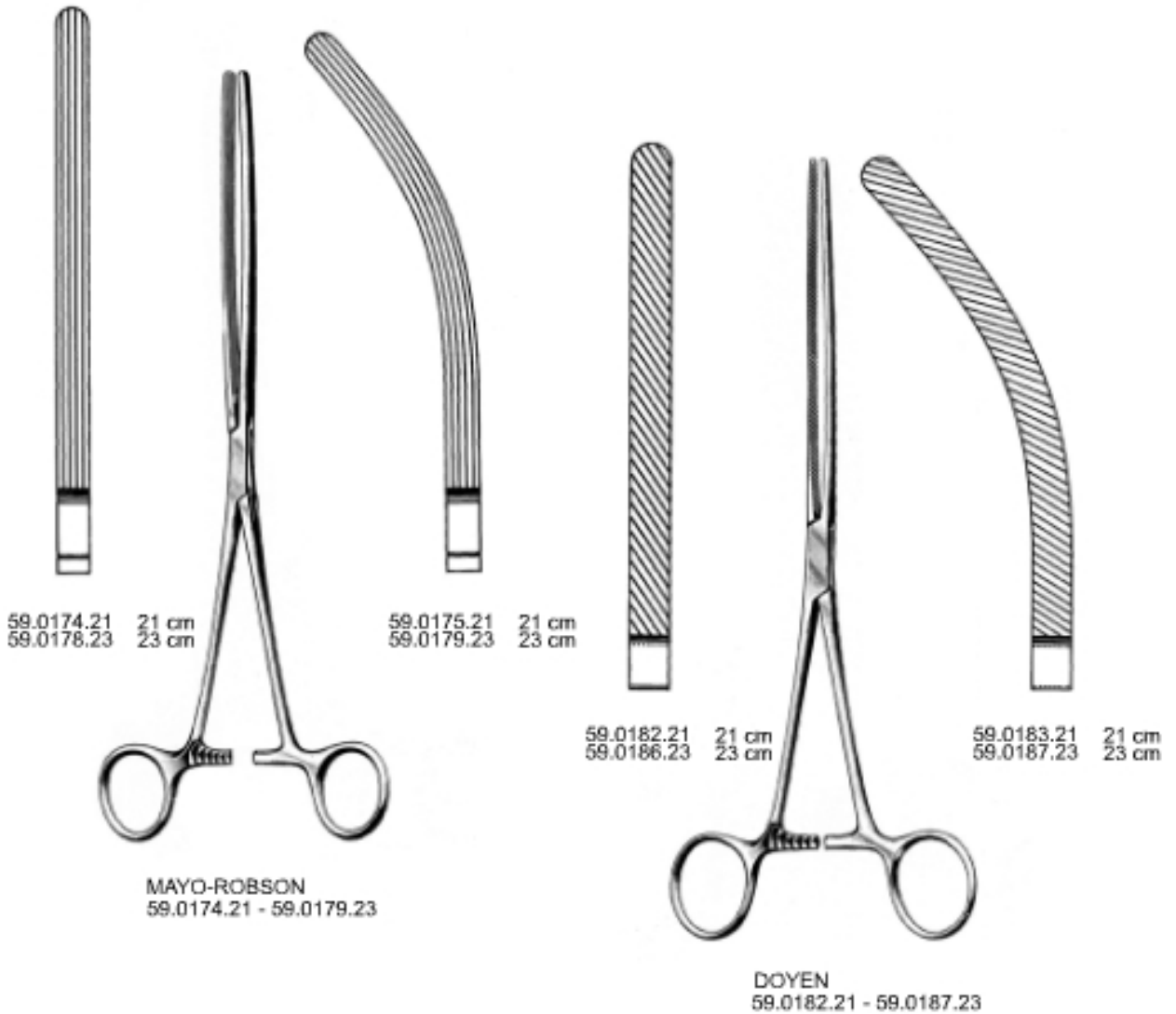

59

Intestinal and Stomach Clamps
Darm und Magenquetschklemmen
Pinzas-Clamps Intestinales Y Estomacales

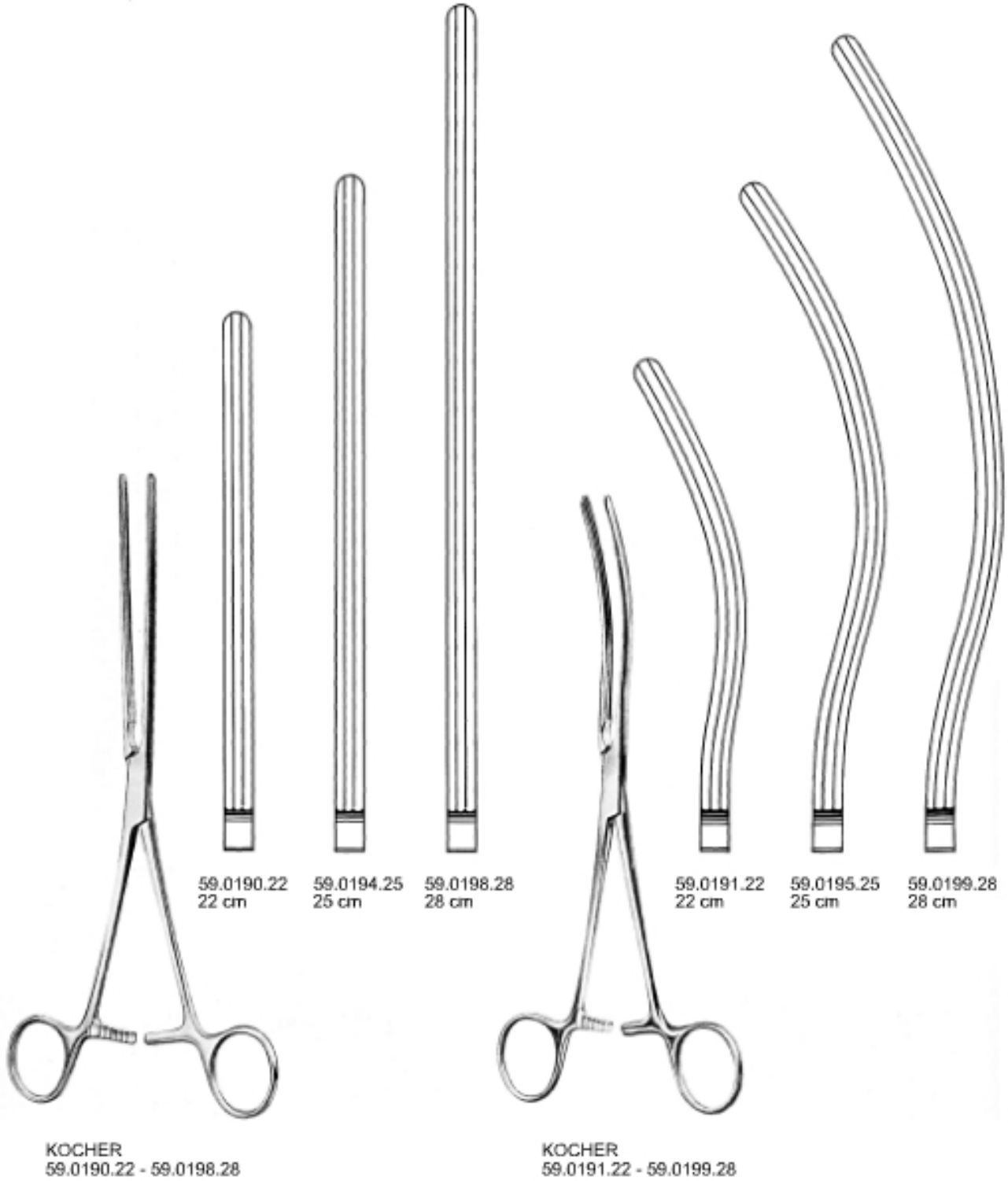

Intestinal and Stomach Clamps
 Darm und Magenquetschklemmen
 Pinzas-Clamps Intestinales Y Estomacales

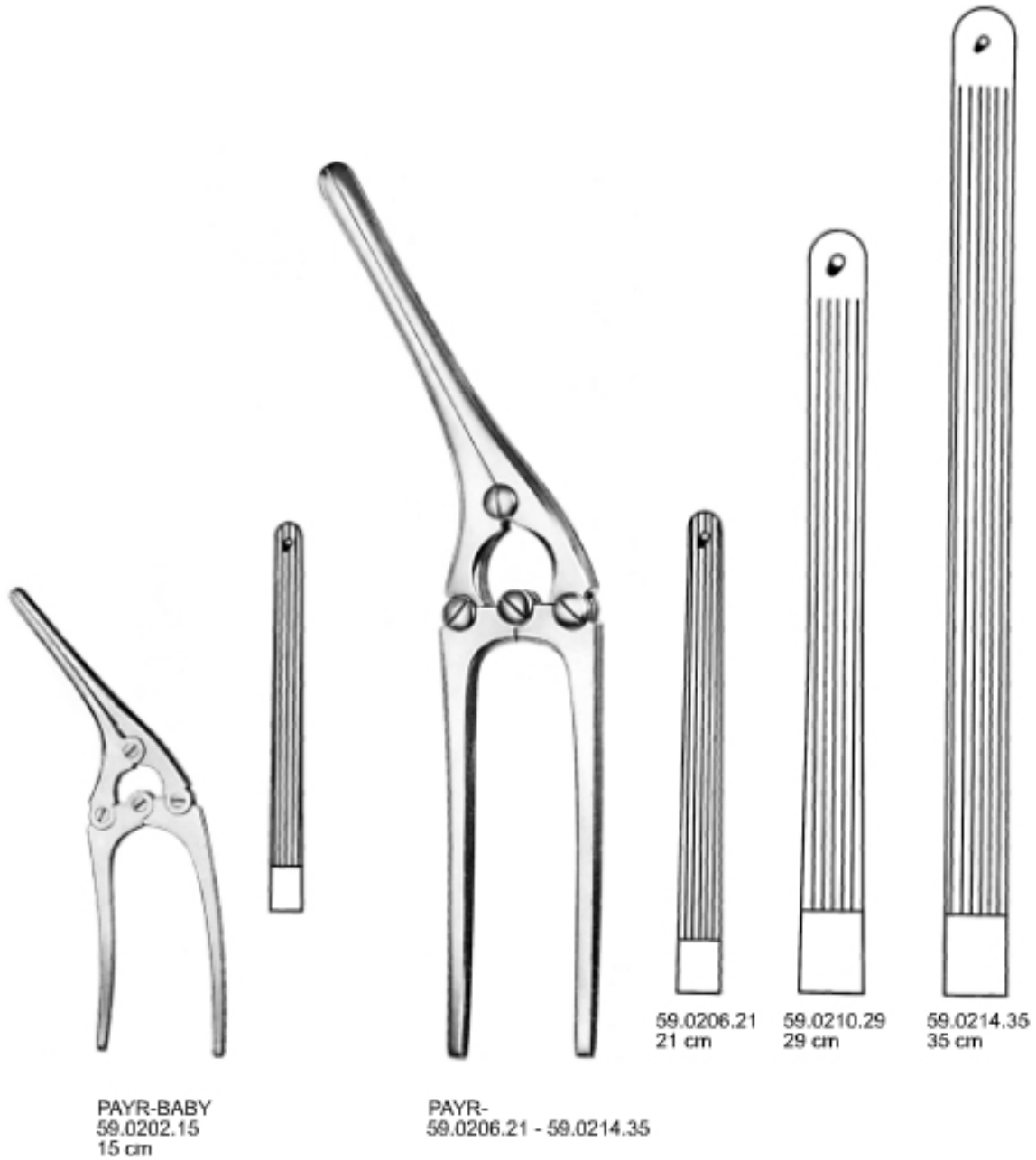

59

Rectal Specula
Mastdarm-Spekula
Especulos Rectales



MATHIEU
59.0220.19
19.5 cm

Vascular Scissors
Gefa Bscheren
Tijeras Vasculares

60



45.0545.18
25°



45.0553.18
45°



45.0561.18
60°



45.0567.18
90°

45.0545.18 - 45.0567.18
18 cm



45.0571.18
25°



45.0575.18
45°



45.0579.18
60°



45.0583.18
90°

45.0571.18 - 45.0583.18
18 cm



55 x 25 mm

MARKHAM-MEYERDING
48.1400.18
18 cm

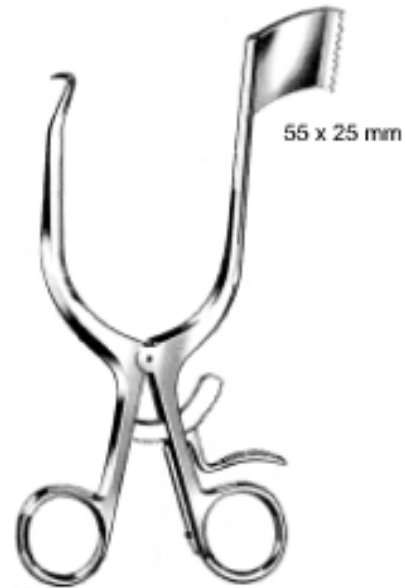

55 x 25 mm

MARKHAM-MEYERDING
48.1404.18
18 cm



GELPI
48.1364.09 9 cm
48.1368.11 11 cm
48.1372.14 14 cm
48.1376.19 19 cm



JANSEN
48.1264.10 10 cm sharp-scharf-agudo
48.1265.10 10 cm blunt-stumpf-romo



BECKMANN

48.1408.31	31 cm	sharp scharf agudo	48.1409.31	31 cm	blunt stumpf romo	4 x 4	teeth zahne dientes
48.1412.33	33 cm		48.1413.33	33 cm		4 x 5	



CONE

48.1416.13	13 cm	sharp scharf agudo	48.1417.13	13 cm	blunt stumpf romo
48.1420.16	16.5 cm		48.1421.16	16.5 cm	
48.1424.20	20 cm		48.1425.20	20 cm	
48.1428.25	25 cm		48.1429.25	25 cm	



BECKMANN-ADSON

48.1432.31	31 cm	sharp scharf agudo	48.1433.31	31 cm	blunt stumpf romo	25 x 25
48.1436.31	31 cm		48.1437.31	31 cm		25 x 30
48.1440.31	31 cm		48.1441.31	31 cm		25 x 40
48.1444.31	31 cm		48.1445.31	31 cm		25 x 45



ADSON
48.1448.27
27 cm



ADSON
48.1456.27
27 cm



ADSON
48.1460.27 27 cm sharp-scharf-agudo
48.1461.27 27 cm blunt-stumpf-roïno



ADSON
48.1452.27
27 cm

Bone Rongeurs Forceps
 Hohlmeißelzangen
 Pinzas Gubias

60



MAYFIELD
 57.0299.17
 17 cm



ZAUFAL-JANSEN
 57.0303.18
 18 cm



ECHLIN
 57.0306.02 - 57.0314.04
 23 cm



STILLE
 57.0318.23
 23 cm

60

Bone cutting Forceps
Knochensplitterzangen
Pincès coupantes

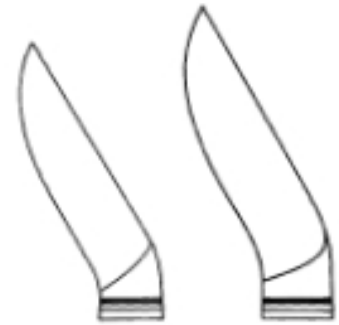

57.0331.23
23 cm

57.0335.27
27 cm



57.0322.22

57.0323.22



STILLE-LUER
57.0322.22 - 57.0323.22
22 cm



STILLE-LISTON
57.0327.27
27 cm



STILLE-LISTON
57.0331.23 - 57.0335.27



Neurosurgery & Laminectomy

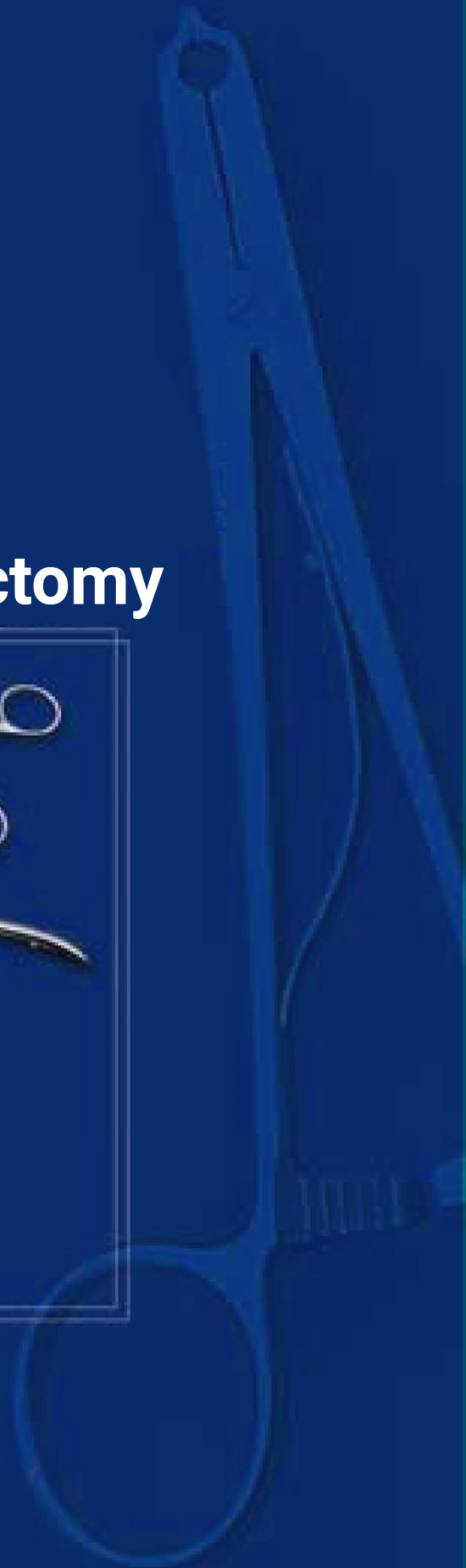

Dura Dissectors
 Dura Dissektoren
 Discacores para Dura-madre

60

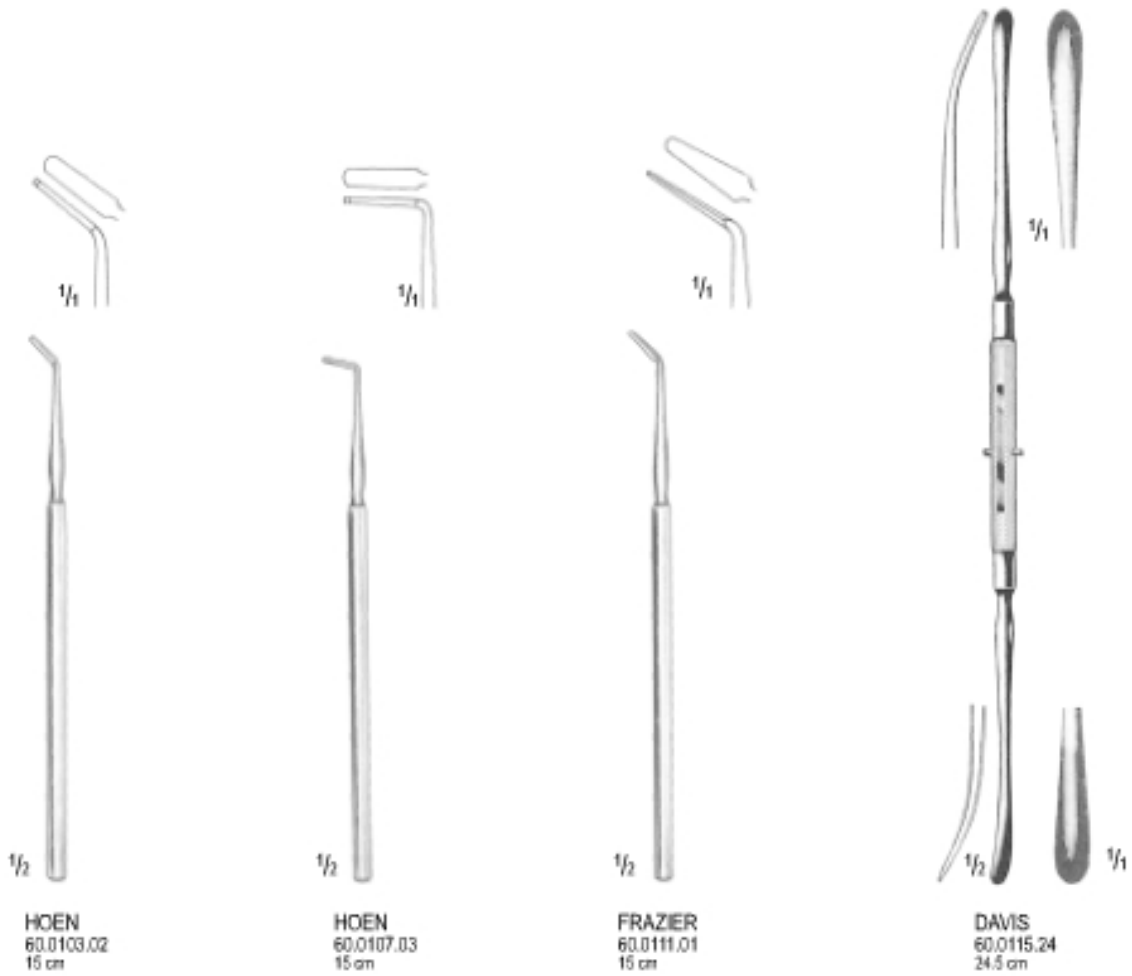

60

Dura Dissectors
Dura Dissektoren
Dissecadores para Dura-madre



PENFIELD
60.0118.01
17.5 cm



PENFIELD
60.0122.02
18.5 cm



PENFIELD
60.0126.03
18.5 cm



PENFIELD
60.0130.04
21.5 cm



PENFIELD
60.0134.05
29 cm

Dura Dissectors
 Dura Dissektoren
 Discacores para Dura-madre



TOENNIS
 60.0138.25
 25 cm



OLIVECRONA
 60.0142.18 18 cm
 60.0146.24 24 cm



OLIVECRONA
 60.0150.19 19.5 cm
 60.0154.24 24 cm

60

Knife Dura Hooks
Messer, Durahaken
Bisturies, Ganchos para Dura-Madre



Nerve Root Retractors, Dura Dissector
 Nervwurzelnhaken Dura Separatoren
 Separadores De Riaz De Nervios

60



60.0186.19

60.0190.19

60.0194.19

LOVE

60.0186.19 - 60.0194.19
 19 cm



HORSLEY
 60.0198.20
 20 cm



SACHS
 60.0203.21
 21 cm

60

Micro Instruments
Mikro Instrumente
Instrumentos para Microcirugia

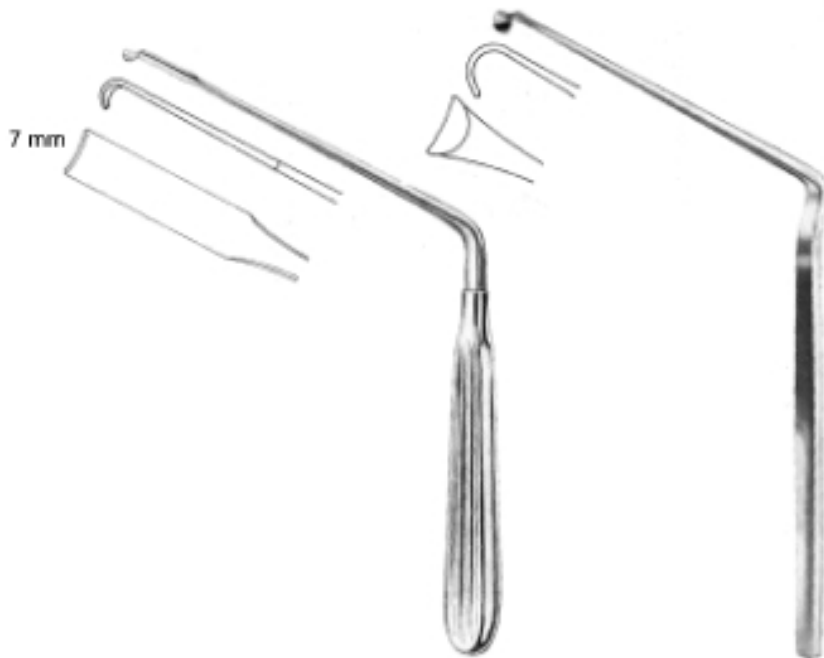

SCOVILLE
60.0207.20
20 cm

MARTIN
60.0211.21
21 cm

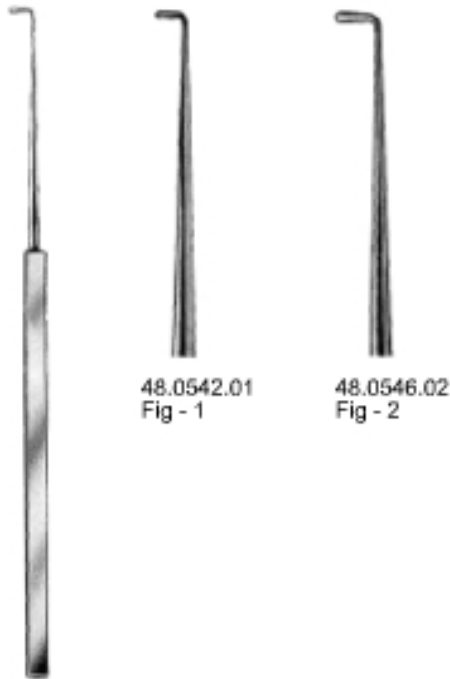

48.0542.01
Fig - 1

48.0546.02
Fig - 2

CUSHING
48.0542.01 - 48.0546.02
19 cm

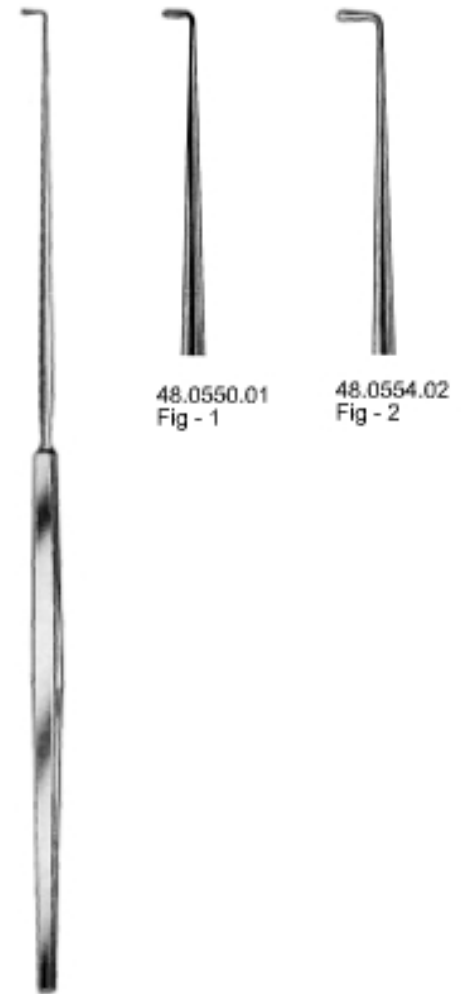

48.0550.01
Fig - 1

48.0554.02
Fig - 2

CUSHING
48.0550.01 - 48.0554.02
28 cm

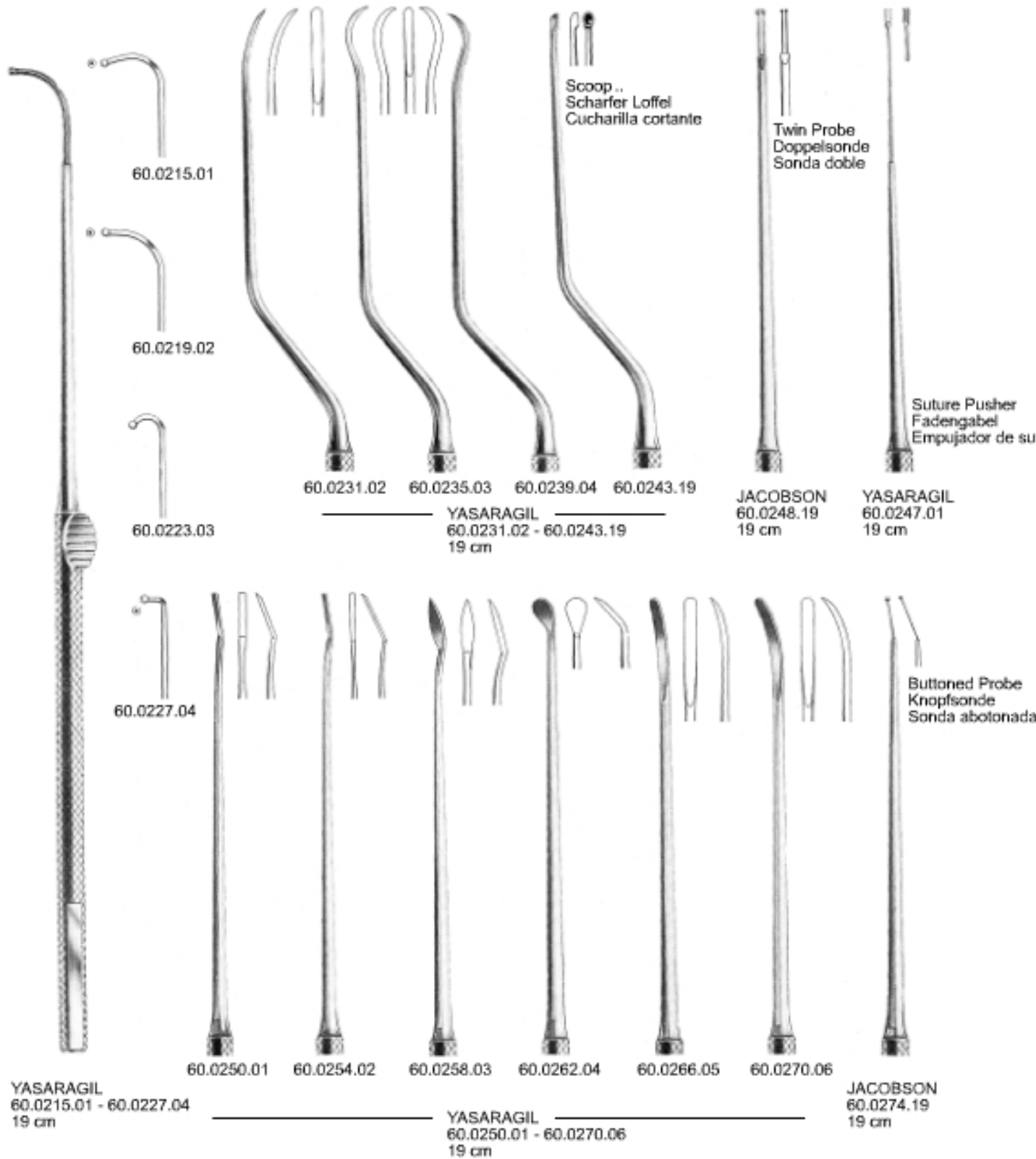

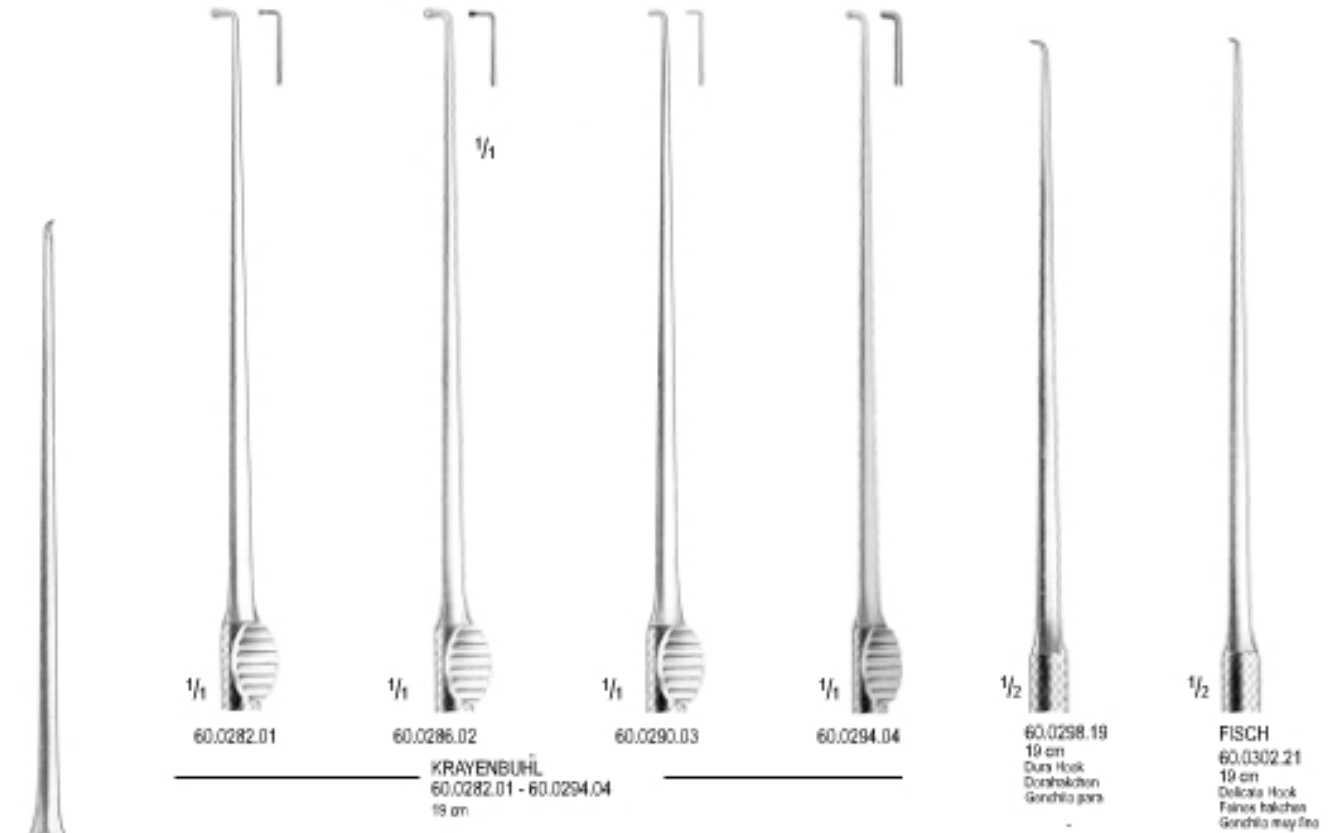

Nerve and Vessel Hooks - Neri- und Gefäßhaken - Gancho para nervios y vasos

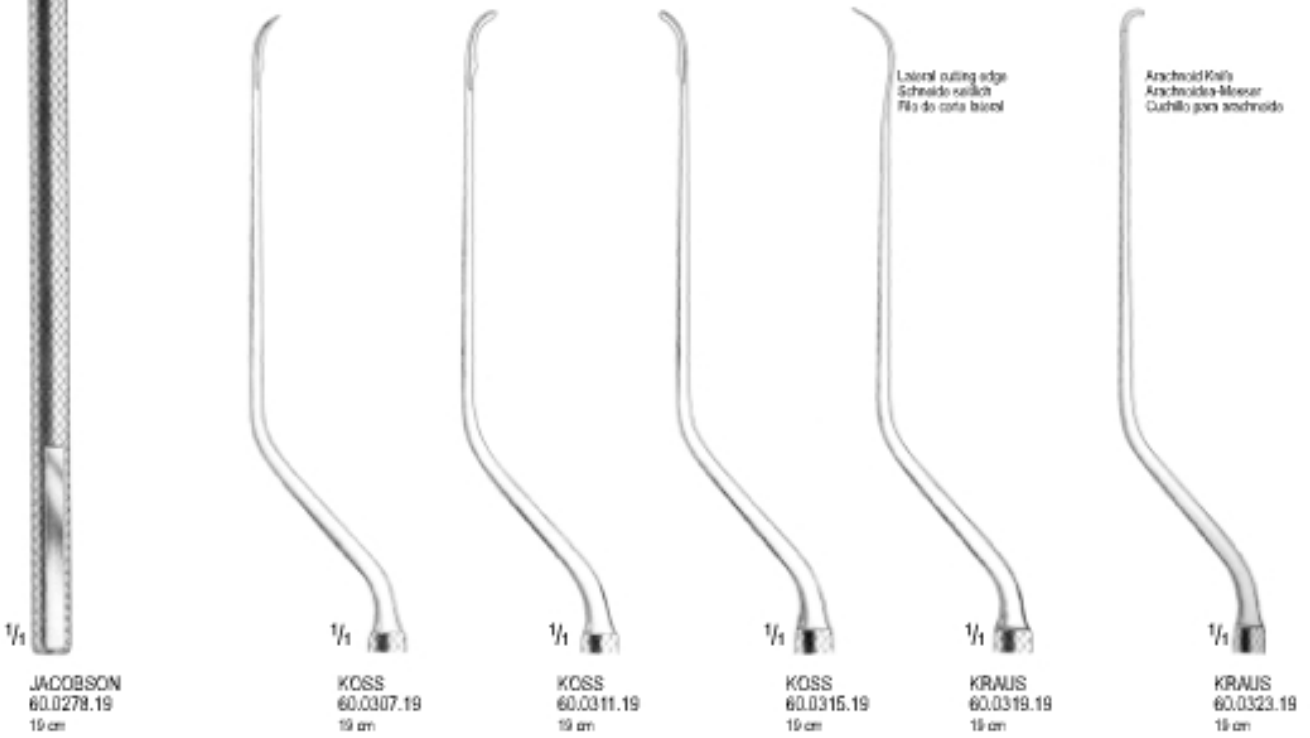

Pituitary Instruments
 Hypophysen Instrumente
 Instrumentos para hipofisis



60.0327.01
 fig-1
 blunt
 stumpf
 romo



60.0331.02
 fig-2
 blunt
 stumpf
 romo



60.0332.03
 fig-3
 sharp
 scharf
 cortante



60.0333.04
 fig-4
 sharp
 scharf
 cortante



HARDY
 60.0334.25
 25 cm



HARDY-FAHLABULCH
 60.0338.01
 fig-1
 sharp
 scharf
 cortante



HARDY-FAHLABULCH
 60.0342.02
 fig-2
 sharp
 scharf
 cortante

60

Pituitary Instruments
Hypophysen Instrumente
Instrumentos para hipofisis



LANDOLT
60.0346.01



LANDOLT
60.0350.02



LANDOLT
60.0354.26

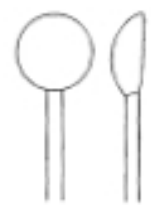

LANDOLT
60.0355.26



LANDOLT
60.0359.26



FAHBUSCH
60.0362.26



FAHBUSCH
60.0363.26

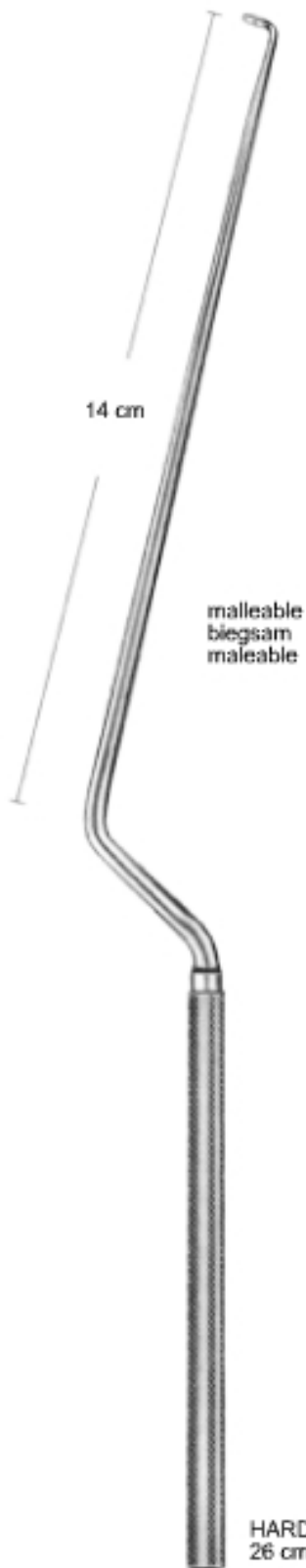

60

Pituitary Instruments
Hypophysen Instrumente
Instrumentos para hipofisis

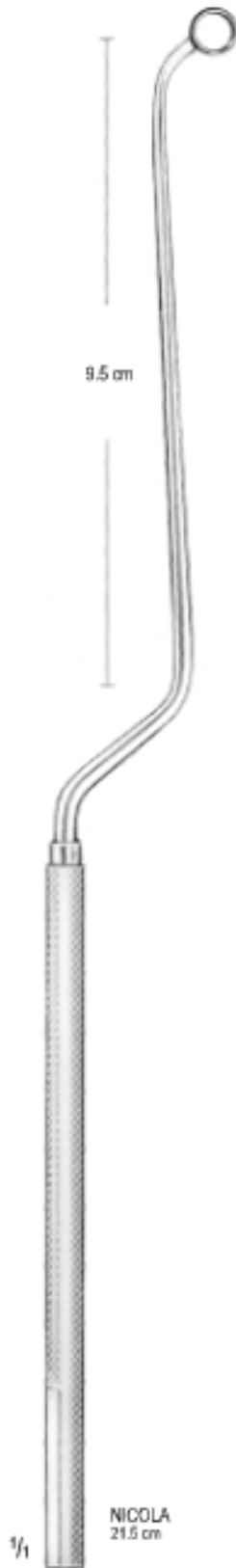

1/16

60.0378.01
malisiblo
hüggen
malisiblo



1/16

60.0382.02
malisiblo
hüggen
malisiblo



1/16

60.0377.01

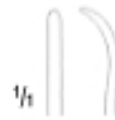

1/16

60.0383.02

Micro Needle Holder
Mikro Nadelhalter
Micro-Porta-Agujas

60



46.0944.18
18 cm



46.0947.18
18 cm



46.0925.14
14 cm



46.0929.14
14 cm

60

Instrument for cranial opening
Instrumente zur schadeloffneng
Instrumentos para abertura-craneana



MARTEL
60.0386.33
33 cm



60.0390.01
Fig-1



60.0394.30 30 cm
60.0398.40 40 cm
60.0402.50 50 cm
60.0406.60 60 cm
60.0410.70 70 cm

OLIVECRONA
60.0394.30 - 60.0410.70



OLDBERG
60.0414.25
21.5 cm



RANEY
60.0418.00



McKENZIE
60.0422.15 15 cm
60.0426.19 19 cm



McKENZIE
60.0431.15 15 cm
60.0435.19 19 cm

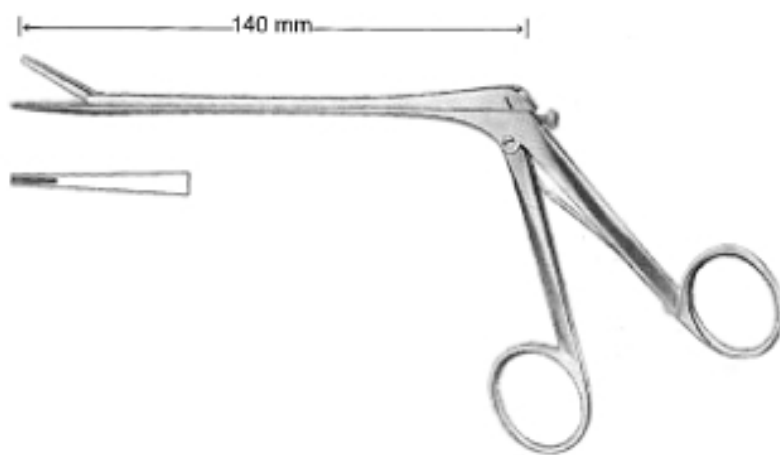

OLIVECRONA - TOENNIS
(Scoville)
60.0439.14

60

Laminectomy Rongeurs
Laminektomie-Zangen
Pinzas Coortantes para Laminectomia

CUSHING
2 mm



2 x 10 mm

60.0442.01 12 cm
60.0446.02 15 cm
60.0450.03 18 cm

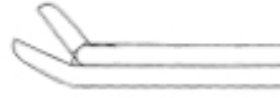

2 x 10 mm

60.0443.01 12 cm
60.0447.02 15 cm
60.0451.03 18 cm

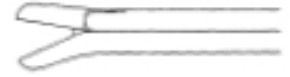

2 x 10 mm

60.0478.01 12 cm
60.0482.02 15 cm
60.0486.03 18 cm

LOVE-GRUENWALD
3 mm



3 x 10 mm

60.0454.04 12 cm
60.0458.05 15 cm
60.0462.06 18 cm



3 x 10 mm

60.0455.04 12 cm
60.0459.05 15 cm
60.0463.06 18 cm



3 x 10 mm

60.0490.04 12 cm
60.0494.05 15 cm
60.0496.06 18 cm

SPURLING
4 mm



4 x 10 mm

60.0466.07 12 cm
60.0470.08 15 cm
60.0474.09 18 cm



4 x 10 mm

60.0467.07 12 cm
60.0471.08 15 cm
60.0475.09 18 cm

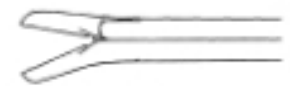





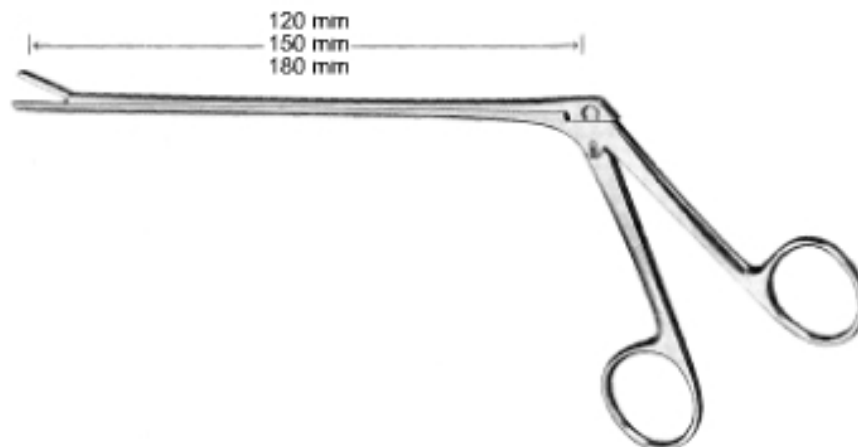



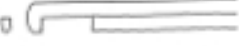



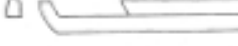

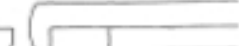
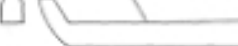
4 x 10 mm

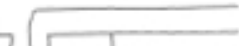
60.0502.07 12 cm
60.0506.08 15 cm
60.0510.09 18 cm

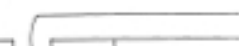

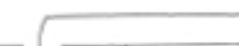
Intervertebral Disc Rongeurs
 Bandscheibenstanzen
 Pinzas Cortantes para Disco Intervertebrales

cutting upward aufwärts schneidend cortante hacia arriba	cutting downward abwärts schneidend cortante hacia abajo	cutting 40° forward vorwärts schneidend 40° cortante hacia delante en angulo de 40°
 60.0515.01 1 mm	 60.0514.01 1 mm	 60.0539.01 1 mm
 60.0519.02 2 mm	 60.0518.02 2 mm	 60.0543.02 2 mm
 60.0523.03 3 mm	 60.0522.03 3 mm	 60.0547.03 3 mm
 60.0527.04 4 mm	 60.0526.04 4 mm	 60.0551.04 4 mm
 60.0531.05 5 mm	 60.0530.05 5 mm	 60.0555.05 5 mm
 60.0535.06 6 mm	 60.0534.06 6 mm	 60.0559.06 6 mm

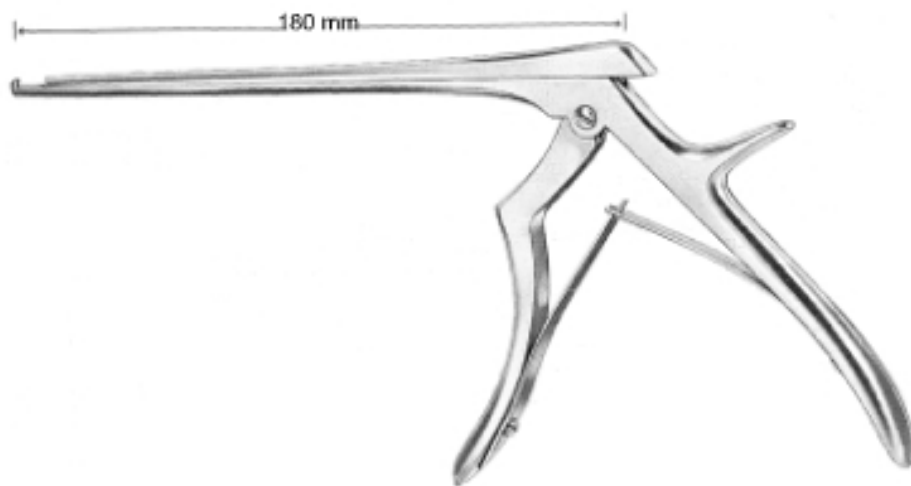

FERRIS-SMITH-KERRISON
 60.0515.01 - 60.0559.06



CRUTCHFIELD
60.0600.00



CLOWARD
60.0604.00

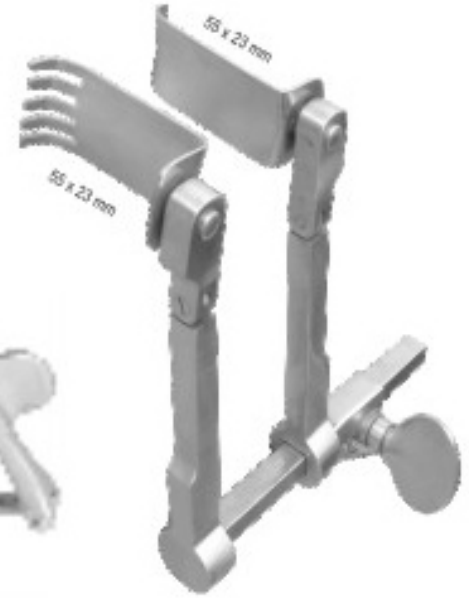

60.0608.00



CASPAR
60.0612.50 5.0 cm
60.0616.55 5.5 cm
60.0620.60 6.0 cm
60.0624.65 6.5 cm



CUSHING LANDOLT
60.0628.70 70 X 15 mm
60.0632.90 90 X 15 mm
60.0636.11 110 X 15 mm



CASPAR
60.0640.80 80 X 11 mm
60.0644.90 90 X 13 mm
60.0650.10 100 X 15 mm



CONE
60.0654.20 20 cm
60.0658.23 23 cm



DeVILBISS
60.0662.21
21 cm

60

Leyla Self-Retaining Retractor,
Leyla-Retraktor,
Retracteur autostatique Leyla,

Brain Spatulas
Hirnspatel
Espatulas Cerebrales



LEYLA
Brain Retractor, Self Retaining,
Flexible for Flat Spatula with 2 Flexible Arms
60-0686-00



- 6 mm - 60-0670-06
- 8 mm - 60-0674-08
- 10 mm - 60-0678-10
- 12 mm - 60-0682-12
- 14 mm - 60-0686-14
- 16 mm - 60-0690-16
- 18 mm - 60-0694-18
- 20 mm - 60-0698-20
- 22 mm - 60-0702-22
- 24 mm - 60-0706-24

Spatula Malleable
18 cm



- 8 x 9 mm - 60-710-09
- 11 x 14 mm - 60-714-14
- 16 x 18 mm - 60-718-18
- 18 x 22 mm - 60-722-22

Spatula Olivercrona
18 cm



Spatula Cushing
60-0726-19 10 x 19 mm
18 cm



Dermatology - Hygiene



Nail Instruments
Instrumente für Finger- und zehennägel
Instrumentos para uñas

61



61

Comedo Extractors, Lupus Currettes, Trephines
Komedoneninstrumente, Lupuslöffel, Trephinen
Saca-comedones, Curetas para lupus, Trepanos

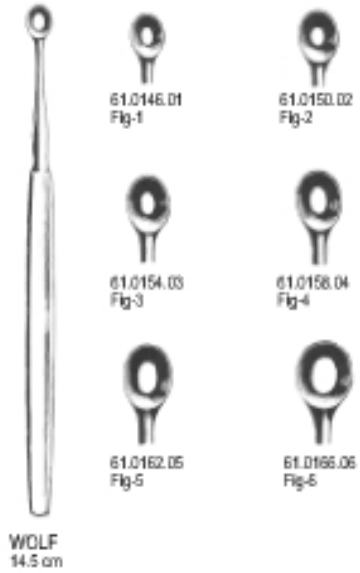

Cuticle Scissors, Nail Filers
 Nagelhautscheren, Nagelfeilen
 Tijeras para uñas, Limes a ongles

61

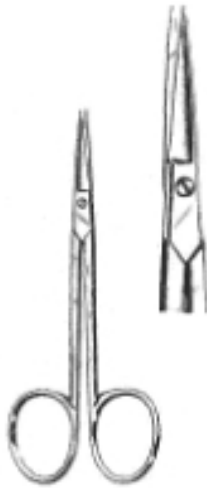

61.0234.10
 10.5 cm
 (32.001.10)

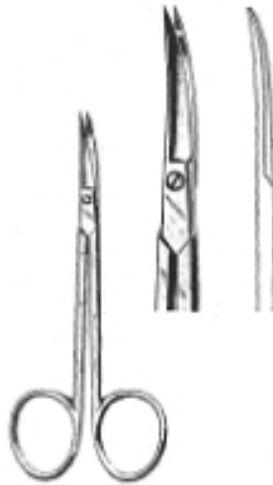

61.0237.10
 10.5 cm
 (32.002.10)



61.0242.10
 10.5 cm
 (32.003.10)



61.0246.10
 10 cm
 (32.004.10)



61.0250.12
 12 cm
 (32.005.12)



61.0254.11
 11 cm
 (32.006.11)

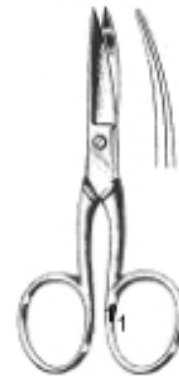

61.0258.10
 10 cm
 (32.007.10)

61

Nail Nippers
Nagelzangen
Pinzas Corta-unas



61.0262.12 12 cm
(32.058.12)



61.0266.11 11 cm (32.059.11)
61.0270.13 13 cm (32.060.13)
61.0274.15 15 cm (32.061.15)



61.0278.11 11 cm (32.062.11)
61.0282.13 13 cm (32.063.13)

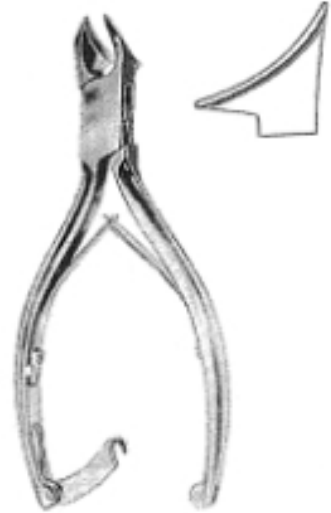

61.0286.14 14 cm
(32.064.14)



61.0290.14 14 cm
61.0294.16 16 cm
(32.065.14 14 cm)
(32.066.16 16 cm)



61.0298.11 11 cm
61.0302.13 13 cm
(32.067.11 11 cm)
(32.068.13 13 cm)
Turnbull



61.0306.13 13 cm
(32.069.13)



61.0310.16 16 cm



Sterilisation





INSTRUMENT BOXES

	L	W	H	
62.0102.00	17	7	3	(20.066.00)
62.0106.00	175	75	3	(20.067.00)
62.0110.00	18	6	3	(20.068.00)
62.0114.00	18	7	3	(20.068.00)
62.0118.00	18	9	4	(20.070.00)
62.0122.00	20	10	4	(20.071.00)
62.0126.00	21	10	4	(20.072.00)



NEEDLE CASE

62.0130.00 (20.073.00)



SYRINGE CASE

62.0134.00 5 cc (20.074.00)
 62.0138.00 2 cc (20.075.00)



FINGER CUP

62.0142.00 (20.076.00)



INSTRUMENT BOXES

	L	W	H		L	W	H		
62.0146.00	30	15	10	(20.077.00)	62.0170.00	40	20	10	(20.083.00)
62.0150.00	30	17	5	(20.078.00)	62.0174.00	40	30	5	(20.084.00)
62.0154.00	34	16	5	(20.079.00)	62.0178.00	40	30	10	(20.085.00)
62.0158.00	36	24	5	(20.080.00)	62.0182.00	42	19	5	(20.086.00)
62.0162.00	36	24	10	(20.081.00)	62.0186.00	45	30	5	(20.087.00)
62.0166.00	40	20	5	(20.082.00)	62.0190.00	45	30	10	(20.088.00)



INSTRUMENT BOXES

	L	W	H	
62.0194.00	12	8	3	
62.0198.00	20	10	5	
62.0202.00	23	15	5	(20.089.00)
62.0206.00	25	12	5	(20.090.00)
62.0210.00	25	12	10	(20.091.00)
62.0214.00	26	15	5	(20.092.00)
62.0218.00	30	15	5	(20.093.00)
62.0222.00	30	20	6	
62.0226.00	32	8	4	(20.094.00)

Sterilizing/Dressing Drum
 Sterilising/Prapariertrommel
 Tambor Para Esterilizacion y Preperacion

62



STERILIZER With HEATER

L W H
 62.0230.00 27 x 12 x 6 cm (20.095.00)



DRESSING / STERILIZING DRUM



DRESSING / STERILIZING DRUM

62.0274.00	8 x 8 cm	(20.106.00)
62.0278.00	10 x 10 cm	(20.107.00)
62.0282.00	12 x 12 cm	(20.108.00)
62.0286.00	15 x 15 cm	(20.109.00)
62.0290.00	16 x 12 cm	(20.110.00)
62.0294.00	18 x 18 cm	(20.111.00)
62.0298.00	19 x 14 cm	(20.112.00)
62.0302.00	19 x 20 cm	(20.113.00)
62.0306.00	20 x 16 cm	(20.114.00)
62.0310.00	20 x 20 cm	(20.115.00)
62.0314.00	24 x 16 cm	(20.116.00)
62.0318.00	24 x 24 cm	(20.117.00)
62.0320.00	24 x 34 cm	
62.0322.00	29 x 14 cm	(20.118.00)
62.0326.00	29 x 16 cm	(20.119.00)
62.0330.00	29 x 24 cm	(20.120.00)

62.0234.00	24 x 12 cm	(20.096.00)	62.0254.00	34 x 28 cm	(20.101.00)
62.0238.00	30 x 15 cm	(20.097.00)	62.0258.00	37 x 30 cm	(20.090.00)
62.0242.00	30 x 30 cm	(20.098.00)	62.0262.00	39 x 14 cm	(20.091.00)
62.0246.00	34 x 16 cm	(20.099.00)	62.0266.00	39 x 20 cm	(20.092.00)
62.0250.00	34 x 24 cm	(20.100.00)	62.0270.00	39 x 29 cm	(20.093.00)

62

Sterilizing/Dressing Drum
Sterilising/Propariertrommel
Tambor Para Esterilizacion y Preperacion



Boiling Sterilizer With Perforated Tray Stand And Lifter

	L	W	H	
62.0334.00	20 x 10	x 5	cm	(20.121.00)
62.0338.00	25 x 12	x 5	cm	(20.122.00)
62.0342.00	26 x 15	x 5	cm	(20.123.00)



Cotton/Dressing Jar with Lid

62.0346.00	7,5 x 7,5	cm	(20.124.00)
62.0350.00	10 x 10	cm	(20.125.00)
62.0354.00	12,5 x 12,5	cm	(20.126.00)
62.0358.00	15 x 15	cm	(20.127.00)
62.0362.00	18 x 18	cm	(20.128.00)
62.0366.00	10 x 12,5	cm	(20.129.00)
62.0370.00	20 x 20	cm	(20.130.00)



Forcep Jar/Cheatle Jar

62.0374.00	5 x 11,5	cm	(20.131.00)
62.0378.00	5 x 16,5	cm	(20.132.00)



Thermometer Jar

62.0382.00	3 x 11	cm	(20.133.00)
------------	--------	----	-------------



Lotion Bowl

62.0386.00	10 cm	(30.003.10)
62.0390.00	12 cm	(30.004.12)
62.0394.00	15 cm	(30.005.15)
62.0398.00	20 cm	(30.006.20)
62.0402.00	25 cm	(30.007.25)



Medicine Cup

62.0406.00	50 cc	(30.008.00)
62.0410.00	100 cc	(30.009.00)



Lotion Cup

62.0414.00	80 x 50 mm	(30.010.00)
------------	------------	-------------

62

Trays
Tableten
Bandejas



L W H
62.0418.00 28 x 18.4 x 1 cm



L W H
62.0422.00 20 x 11.5 x 2 cm



Instrument Tray		
	L W H	
62.0426.00	9.2 x 5.4 x 1 cm	(30.012.00)
62.0430.00	15 x 10 x 1 cm	(30.013.00)
62.0434.00	18.5 x 10.5 x 1 cm	(30.014.00)
62.0438.00	19 x 10 x 1.5 cm	(30.015.00)
62.0442.00	20 x 10 x 1 cm	(30.016.00)
62.0446.00	20 x 15 x 1 cm	(30.017.00)
62.0450.00	25 x 15 x 1 cm	(30.018.00)
62.0454.00	28 x 19 x 2 cm	(30.019.00)
62.0458.00	29 x 19 x 1 cm	(30.020.00)



Kidney Tray		
62.0462.00	12 cm	(30.021.12)
62.0466.00	15 cm	(30.022.15)
62.0470.00	20 cm	(30.023.20)
62.0474.00	25 cm	(30.024.25)
62.0478.00	30 cm	(30.025.30)

Iodine and Sterilizing Forceps
 Jodpinzetten Sterilisierzangen
 Pinzas Papa Yodo y esterilizacion



62.0500.20 20 cm
 62.0504.30 30 cm



CHEATLE
 62.0508.27
 27 cm



ROGGE
 60.0512.23
 23 cm



UNIVERSAL STRAIGHT
 60.0516.20 23 cm
 60.0520.28 28 cm



GURVED
 60.0517.20 23 cm
 60.0521.28 28 cm



SURGICAL INSTRUMENTS

Life Saving Instruments

Inquiry now Today Call us!
WhatsApp# +92 321 6150213

for Email
info@alfazeelatcorp.com

Contact address
**Wazirabad Road, Raheem Pur
Ugoki Sialkot, PAKISTAN**

