

# High Quality Dental Instruments



✉ info@alfazeelatcorp.com

☎ +92 321 6150213

🌐 www.alfazeelatcorp.com

📍 **Address:** Wazirabad Road,  
Raheem Pur Ugoki Sialkot  
PAKISTAN

DEPARTMENT #	NAME	FROM PAGE#	TO PAGE#
01	ROOT ELEVATORS.	01	18
02	DRESSING FORCEPS.	19	38
03	PERIOSTEAL ELEVATORS.	39	46
04	EXTRACTING FORCEPS.	47	105
05	PERIODONTAL INSTRUMENTS.	106	114
06	SCALERS.	115	132
07	EXCAVATORS.	133	143
08	PROBES AND EXPLORERS.	144	150
09	ENDODONTIC AND NEVER INSTRUMENTS.	151	154
10	CEMENT SPATULAS.	155	159
11	AMALGAM INSTRUMENTS.	160	168
12	BONE CURETTES.	169	176
13	FILLING INSTRUMENTS.	177	206
14	BONE RONGEUR FORCEPS.	207	216
15	MOUTH GAGS AND TONGUE RETRACTORS.	217	222
16	DISSECTING SCISSORS.	223	234
17	TISSUE RETRACTORS.	235	244
18	ARTERY FORCEPS.	245	253
19	NEEDLE HOLDERS.	254	265
20	INSTRUMENTS BOXES.	266	272
21	RUBBER DAM INSTRUMENTS.	273	280
22	CROWN INSTRUMENTS.	281	287
23	AMALGAM CARRIERS.	288	295
24	MOUTH MIRRORS HANDLES.	296	300
25	SCALPLE HANDLES.	301	304
26	HAMMERS.	305	308
27	CARVING INSTRUMENTS.	309	318
28	WAX KNIVES.	319	331
29	IMPRESSION TRAYS.	332	350
30	TRAYS AND BOWLS.	351	359
31	ORTHODONTICS PLIERS.	360	375
32	SISSORS.	376	382

Department

01

ROOT ELEVATORS  
WURZELHEBER  
ELEVADORES PARA RAICES

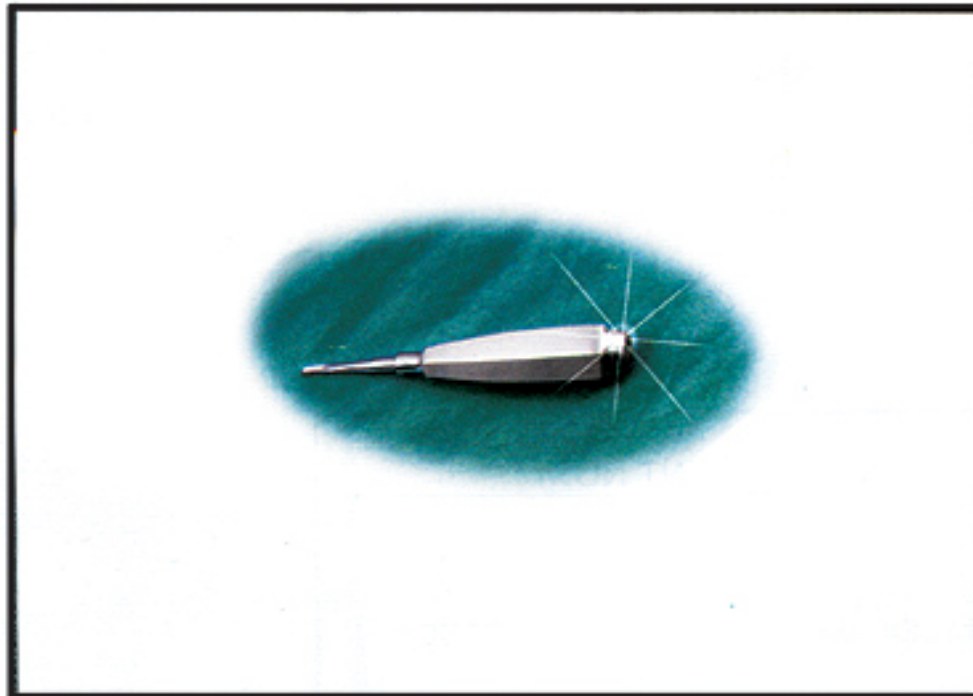

DEPARTMENT NO. 1

---

FROM  
PAGE#

1

TO  
PAGE#

18

INSTRUMENTS CATEGORY

ROOT ELEVATORS  
WURZELHEBER  
ELEVADORES PARA RAICES

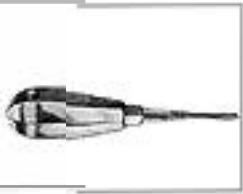

ROOT ELEVATORS  
WURZELHEBER  
ELEVADORES PARA RAICES

01



01-001-00



01-002-00



01-003-00



01-004-00



01-005-00

ROOT ELEVATORS  
WURZELHEBER  
ELEVADORES PARA RAICES



9

01-006-09



8

01-006-08



7

01-006-07



6

01-006-06



14

01-006-14



13

01-006-13



12

01-006-12



11

01-006-11



6

01-006-06  
Ben



ROOT ELEVATORS  
WURZELHEBER  
ELEVADORES PARA RAICES

01



1  
01-007-01  
Bein



2  
01-007-02



3  
01-007-03



4  
01-007-04



5  
01-007-05



6  
01-007-06



7  
01-007-07



8  
01-007-08



9  
01-007-09



10  
01-007-10



11  
01-007-11



12  
01-007-12

ROOT ELEVATORS  
WURZEL-HEBER  
ELEVADORES PARA RAICES

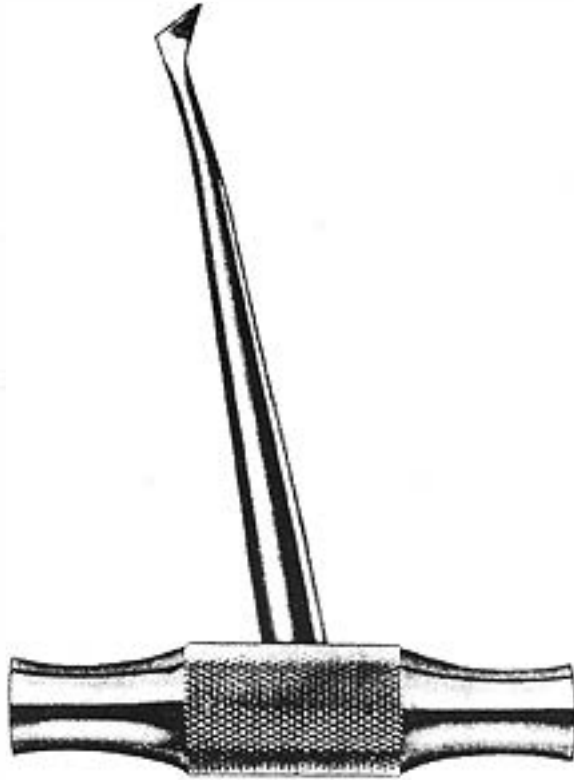

01-058-00  
Barty



01-058-01 01-058-02



01-058-03 01-058-04



11 12  
01-058-11 01-058-12



17 18  
01-058-17 01-058-18



9 10  
01-059-09 01-059-10



11 12  
01-059-11 01-059-12



13  
01-059-13



14  
01-059-14

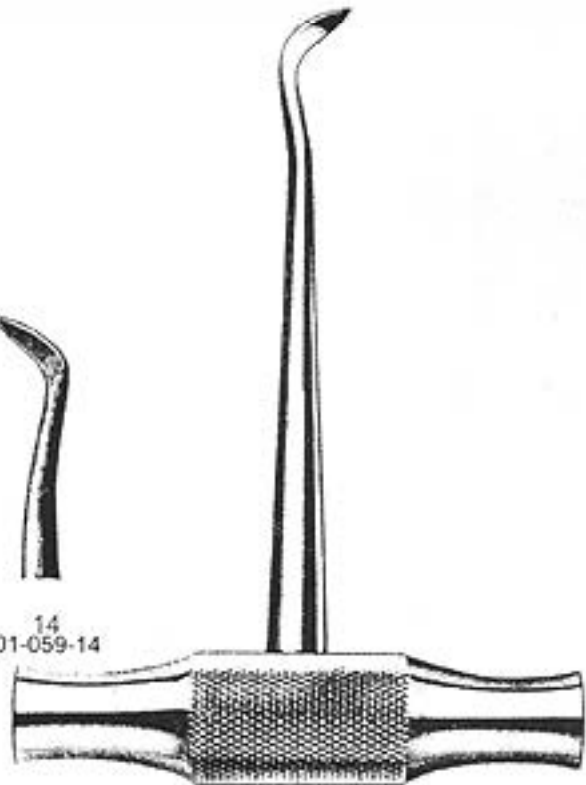

01-059-00  
Winter



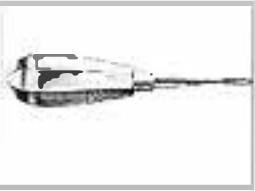

ROOT ELEVATORS  
WURZELHEBER  
ELEVADORES PARA RAICES

01



01-110-00  
Ratzow

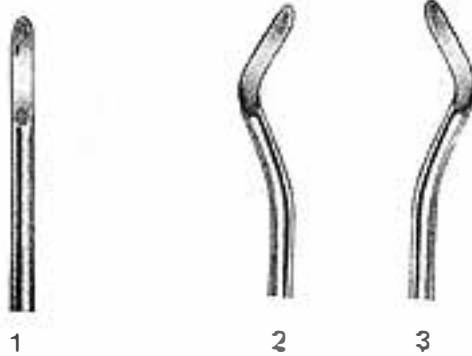

1 2 3  
Ratzow

01-110-01 01-110-02 01-110-03



01-111-00  
4.5mm  
Hyjin

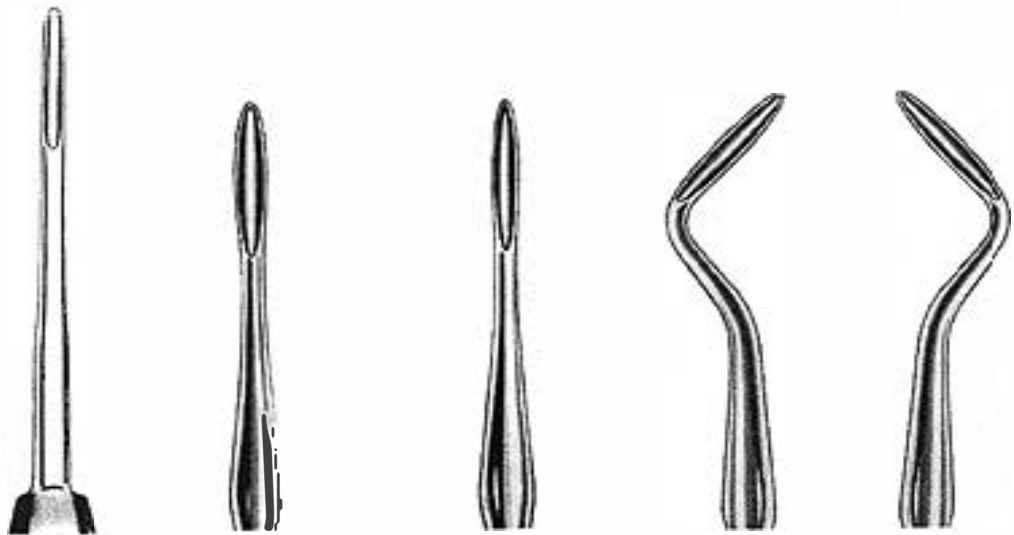

1 2 3 4 5  
2 mm 4.5mm 3mm 3mm 3mm  
Hyjin

01-111-01 01-111-02 01-111-03 01-111-04 01-111-05

7

ROOT ELEVATORS  
WURZELHEBER  
ELEVADORES PARA RAICES

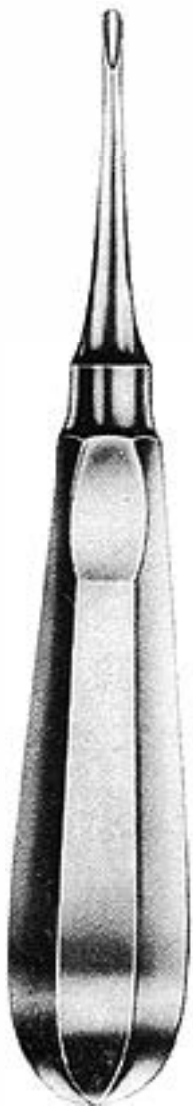

1  
01-112-01  
Apical 301

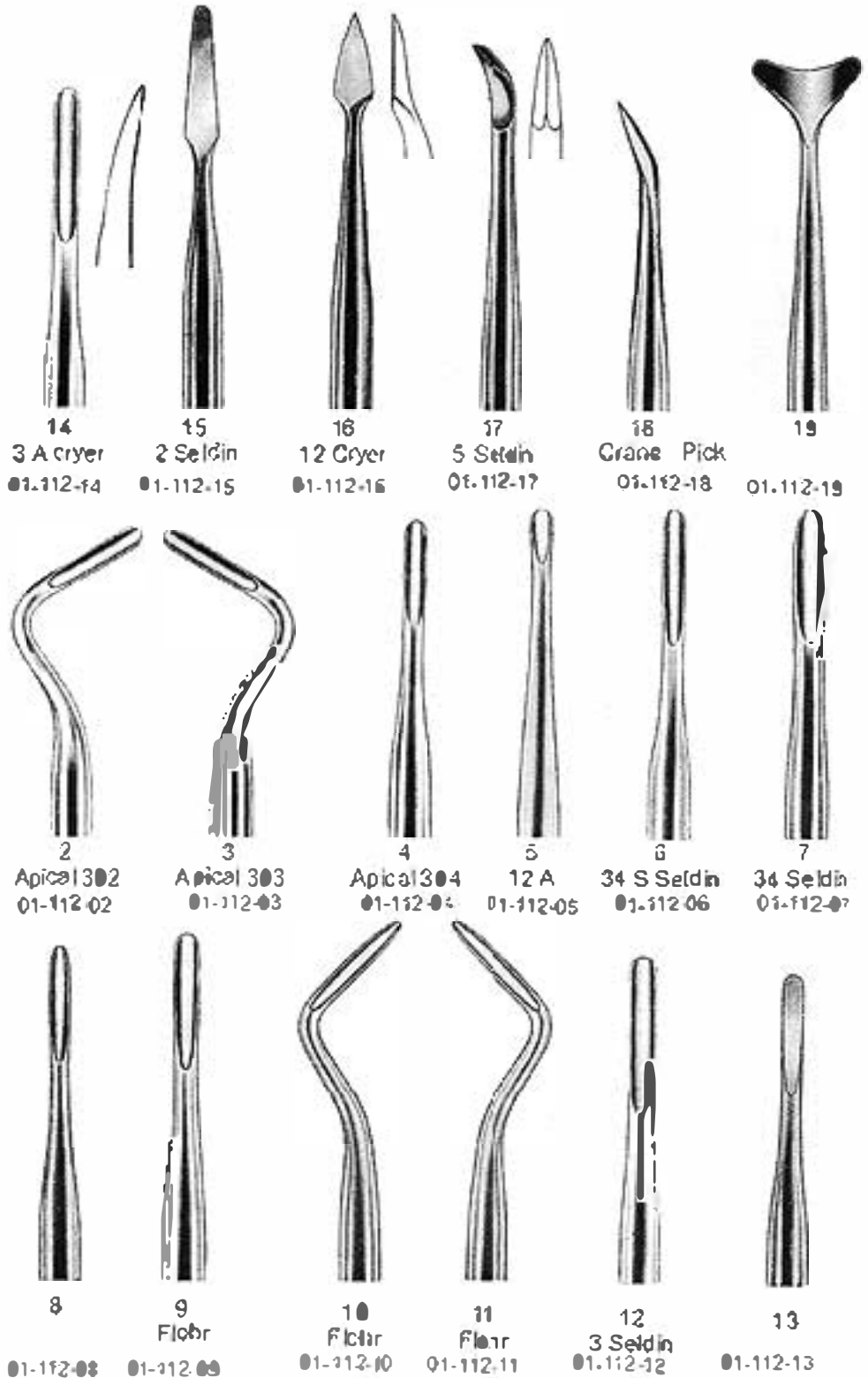



ROOT ELEVATORS  
WURZELHEBER  
ELEVADORES PARA RAICES

01



1  
01-113-01  
Flöhr



8  
Heidbrink  
01-113-08



9  
Heidbrink  
01-113-09



10  
Heidbrink  
01-113-10



11  
01-113-11



12  
01-113-12



2  
Flöhr  
01-113-02



3  
Flöhr  
01-113-03



4  
Flöhr  
01-113-04



5  
Flöhr  
01-113-05



6  
Friedman  
01-113-06



14  
01-113-14



15  
01-113-15



16  
01-113-16



17  
01-113-17



18  
01-113-18

01

ROOT ELEVATORS  
WURZELHEBER  
ELEVADORES PARA RAICES

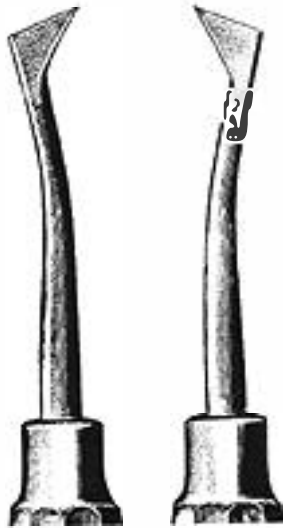

23

24

بـ Ceyer

01-114-23 01-114-24



81

01-114-81

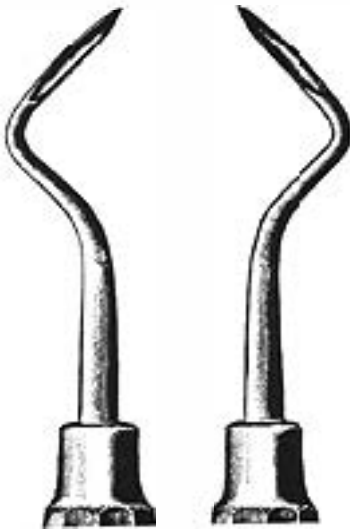

4

5

بـ Apical

01-114-04 01-114-05



6

01-114-06



81

01-114-00

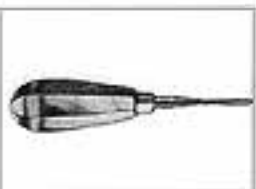

ROOT ELEVATORS  
WURZELHEBER  
ELEVADORES PARA RAICES

01



2  
Apical 302  
01-115-02



3  
Apical 303  
01-115-03



4  
Apical 304  
01-115-04



5  
i2A  
01-115-05



6  
34S Seldin  
01-115-06



7  
34 Seldin  
01-115-07

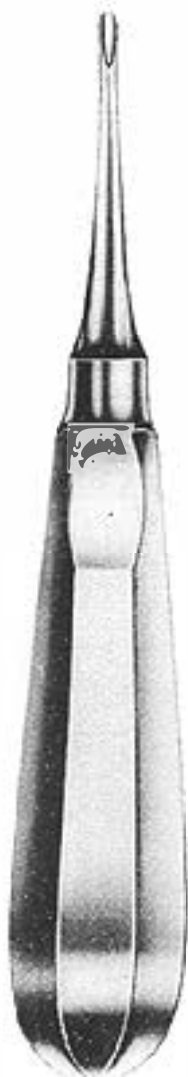

1  
01-115-01  
Apical 301



14  
3A Cryer  
01-115-14



15  
2 Seldin  
01-115-15



16  
12 Cryer  
01-115-16



17  
5 Seldin  
01-115-17



18  
Crane Pick  
01-115-18



19  
01-115-19



8  
01-115-08



9  
Flohr  
01-115-09



10  
Flohr  
01-115-10



11  
Flohr  
01-115-11



12  
3 Seldin  
01-115-12



13  
01-115-13

ROOT ELEVATORS  
WURZELHEBER  
ELEVADORES PARA RAICES



20  
01-116-20



21  
01-116-21



22 Miller 1  
01-116-22

23 Miller 2  
01-116-23

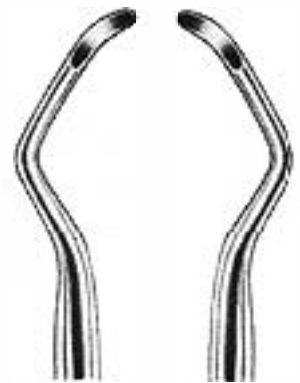

24 Miller 3  
01-116-24

25 Miller 4  
01-116-25

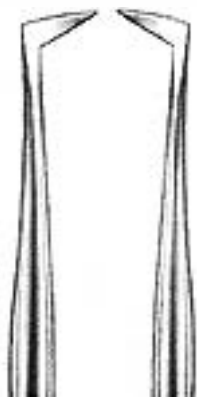

26  
01-116-26

27  
01-116-27

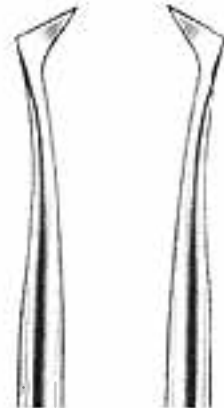

28  
01-116-28

29  
01-116-29

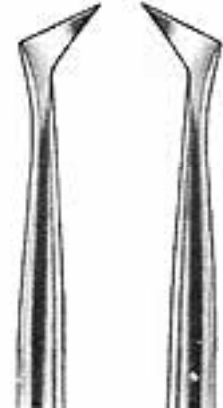

30  
01-116-30

31  
01-116-31



ROOT ELEVATORS  
WURZELHEBER  
ELEVADORES PARA RAICES

01

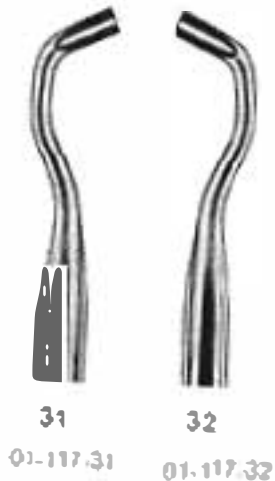
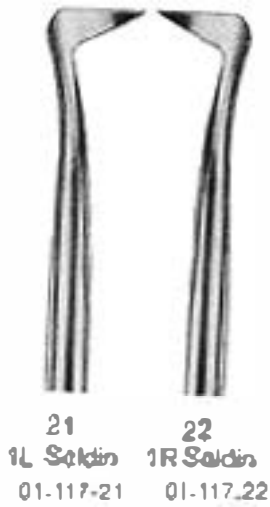

ROOT ELEVATORS  
WURZELHEBER  
ELEVADORES PARA RAICES



01-168-00



1 01-168-01 2 01-168-02



01-169-00



1 01-169-01



2 01-169-02



3 01-169-03



1 01-170-01



2 01-170-02



01-170-00





01-171-00  
 Schlemmer  
 1-2



1  
 01-171-01



2  
 01-171-02



1  
 01-172-01



2  
 01-172-02



3  
 01-172-03



01-172-00  
 Thomson  
 1-6



4  
 01-172-04



5  
 01-172-05



6  
 01-172-06

ROOT ELEVATORS  
WURZELHEBER  
ELEVADORES PARA RAICES



01-223-01  
Chompert



2  
01-223-02



3  
01-223-03



4  
01-223-04



1  
01-224-01  
Heidbrink



2  
01-224-02  
Heidbrink



3  
01-224-03  
Heidbrink



1  
01-225-01



2  
01-225-02



3  
01-225-03



ROOT ELEVATORS  
WURZELHEBER  
ELEVADORES PARA RAICES

01

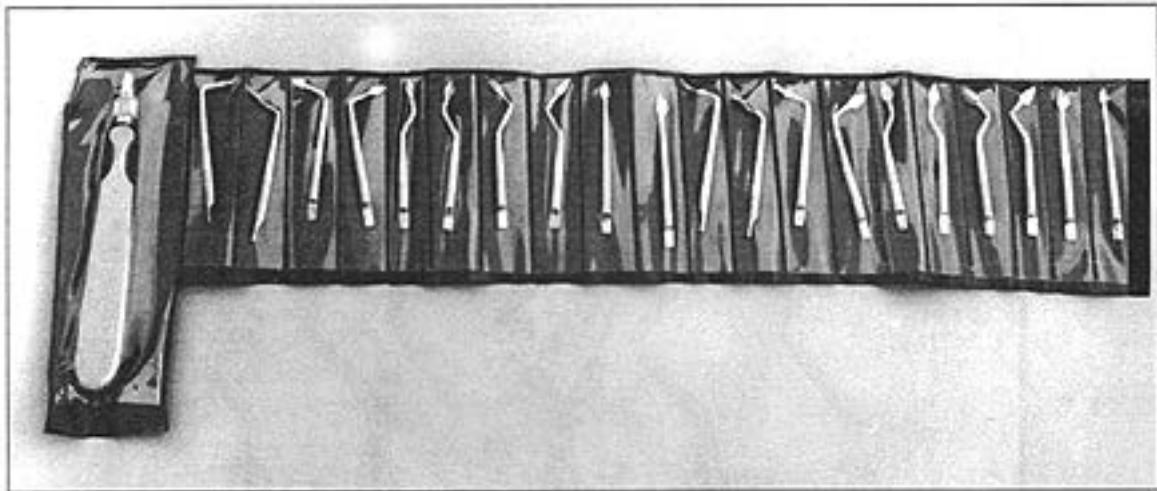

01-226-00  
Elevators set with 20 detachable points

ROOT ELEVATORS  
WURZELHEBER  
ELEVADORES PARA RAICES



1  
01-277-00  
Heidbrink



1  
01-277-01



2  
01-277-02



3  
01-277-03



1  
01-278-00  
Heidbrink



1  
01-278-01



2  
01-278-02



3  
01-278-03



4  
01-278-04



5  
01-278-05



6  
01-278-06

Department

02

**TWEEZER**  
**ZHAN PINZETTEN**  
**PINZAS**

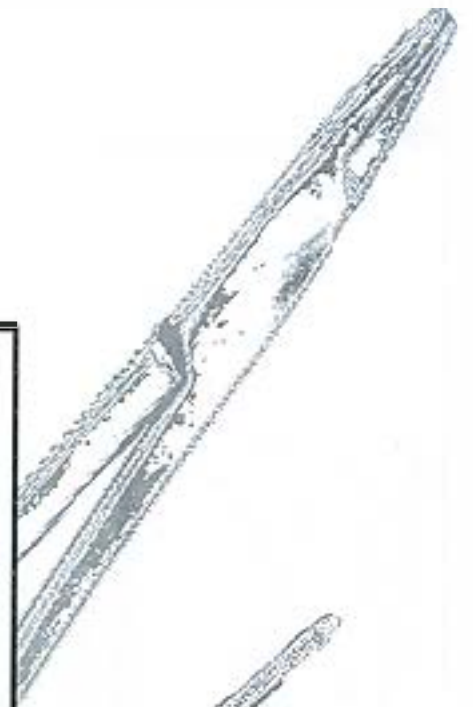
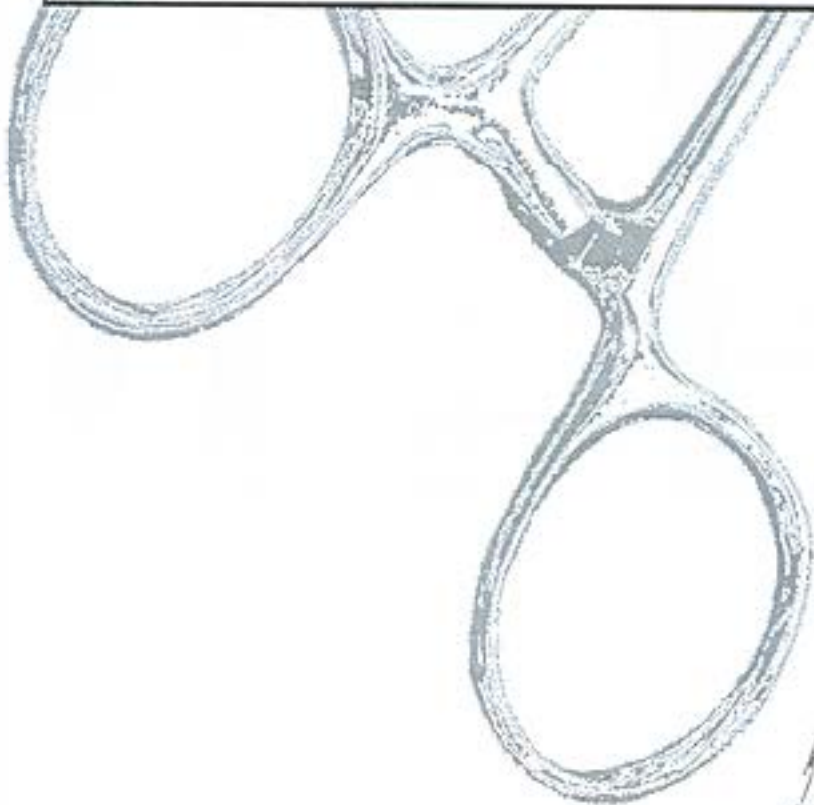
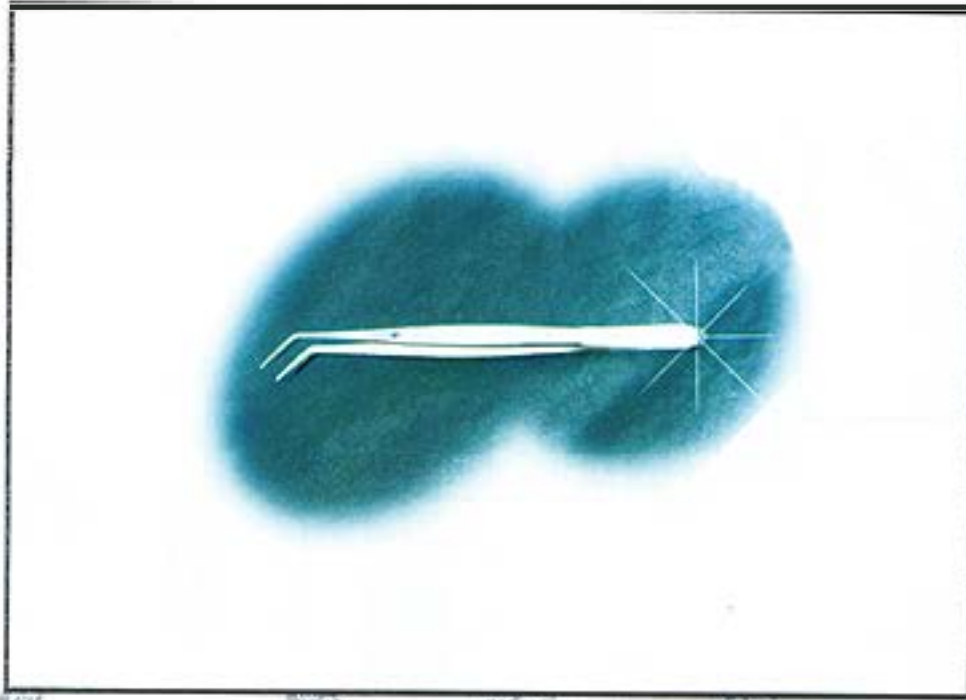



DEPARTMENT NO. 2

FROM  
PAGE#

19

TO  
PAGE#

38

INSTRUMENTS CATEGORY

DRESSING FORCEPS  
INSTRUMENTS ANATOMISCHE PINZETTEN  
PINZAS DE DISECCION

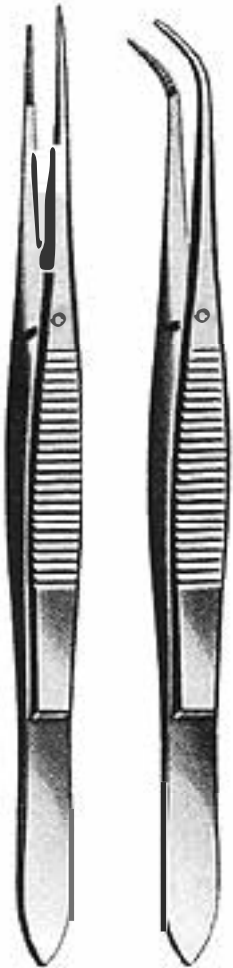

02-001-13  
13 cm

02-002-13  
13 cm  
Perry

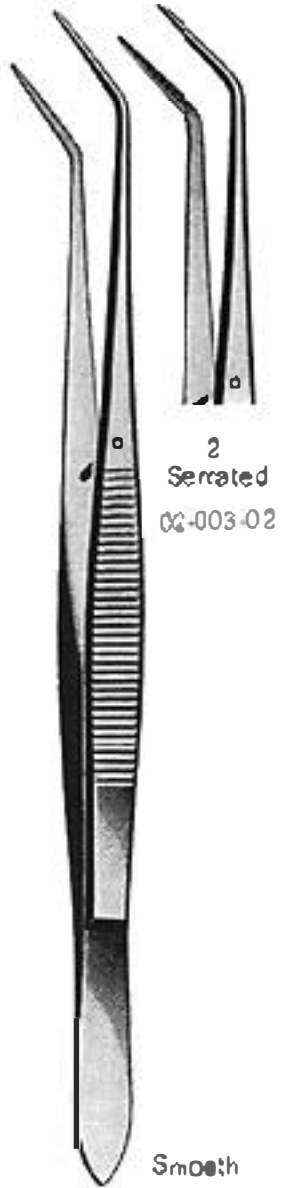

2  
Serrated  
02-003-02

Smooth

1  
02-004-16  
16 cm  
College

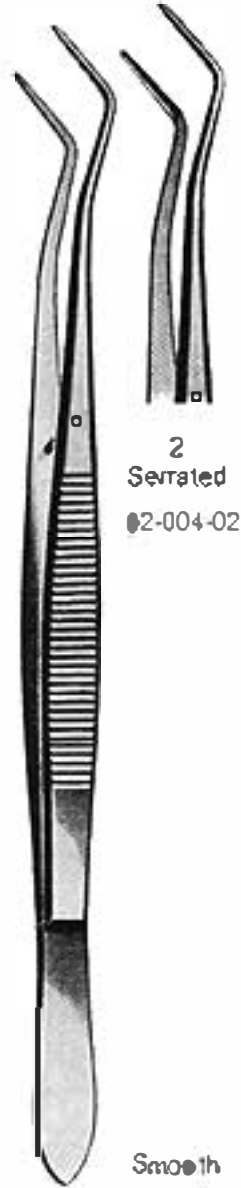

2  
Serrated  
02-004-02

Smooth

1  
02-004-16  
16 cm  
Meriam



2  
Serrated  
02-005-02

Smooth

1  
02-005-16  
16 cm

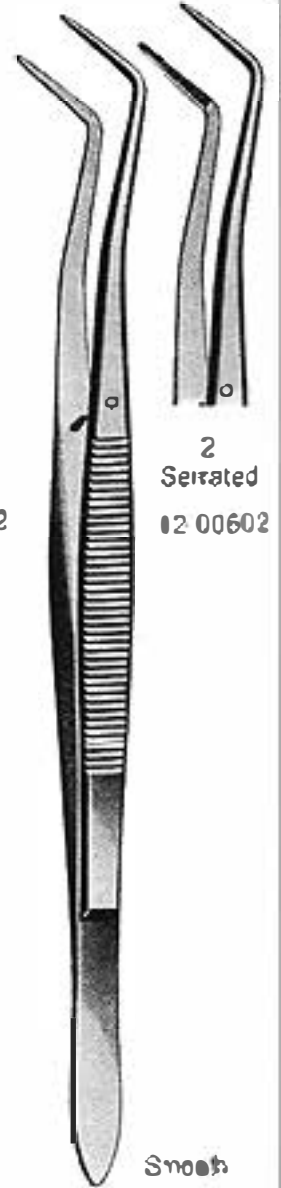

2  
Serrated  
02-006-02

Smooth

1  
02-006-16  
16 cm

Flagg

# TWEEZERS ZHAN PINZETTEN PINZAS

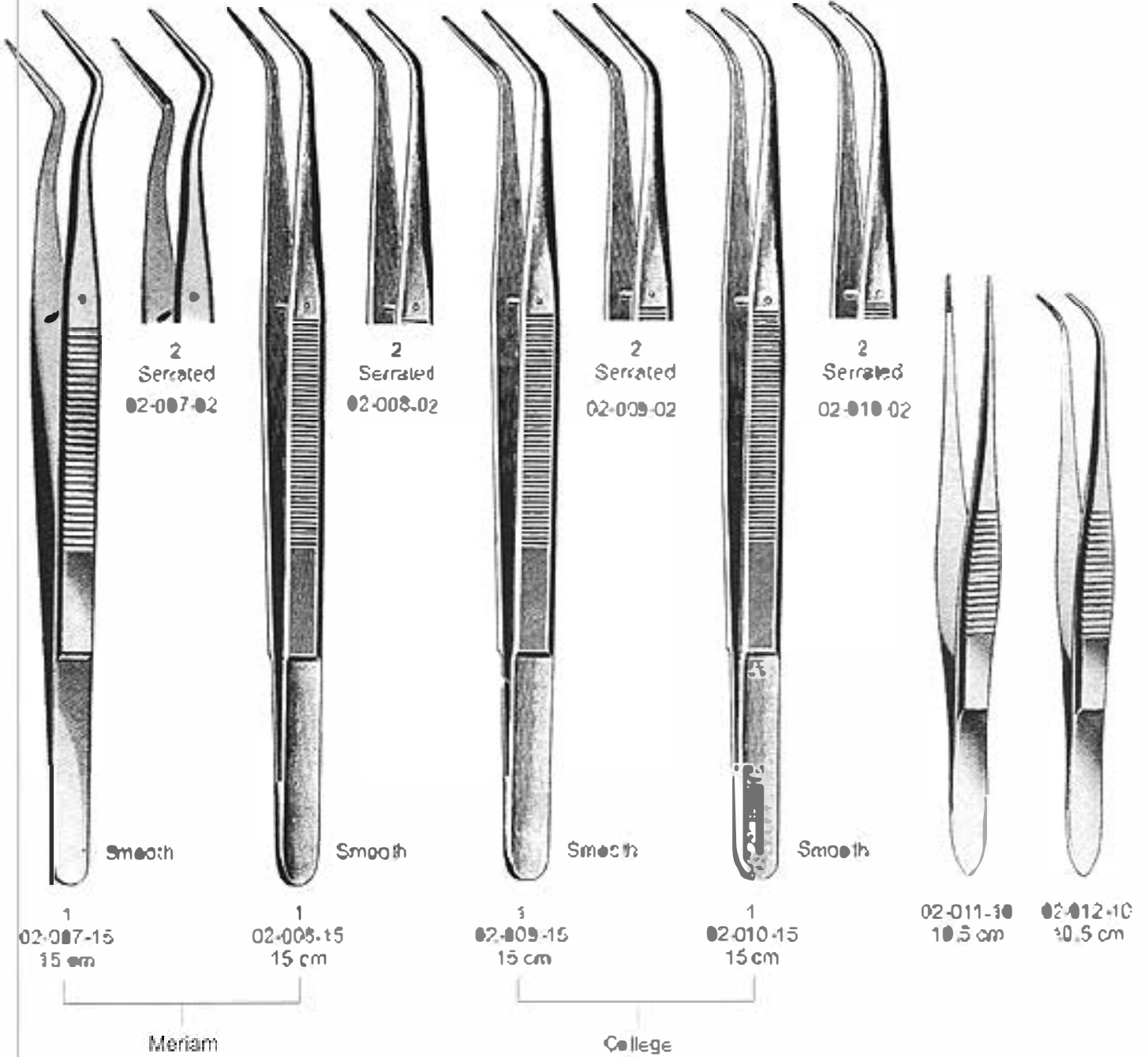





t  
02-013-00  
Perry



t9  
02-014-00



18  
02-015-00



17  
02-016-00



3  
02-017-00

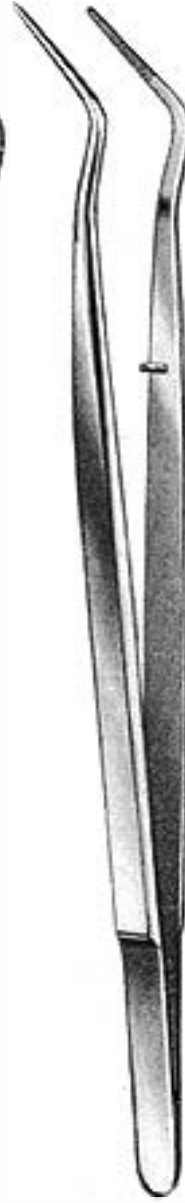

2  
02-018-00  
College



18L  
02-019-00

# TWEEZERS ZHAN PINZETTEN PINZAS

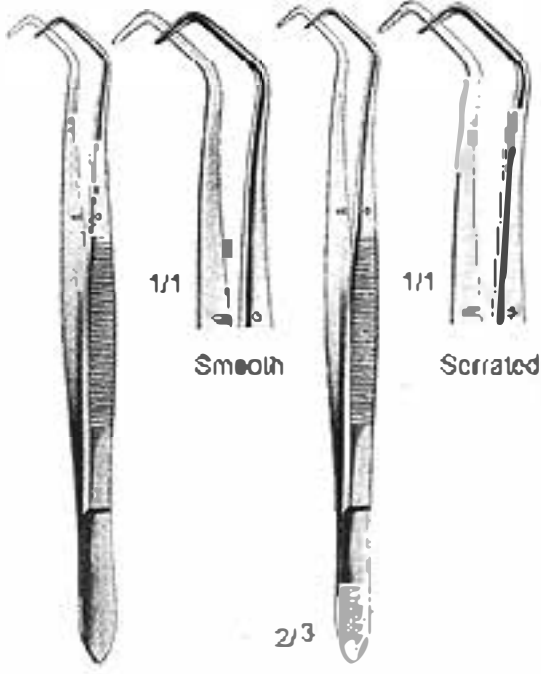

02-020-15  
15 cm

02-021-15  
15 cm

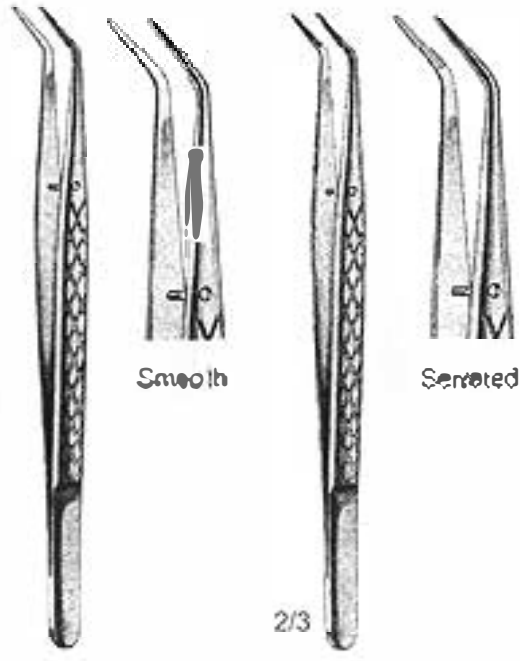

02-022-15  
15 cm

02-023-15  
15 cm

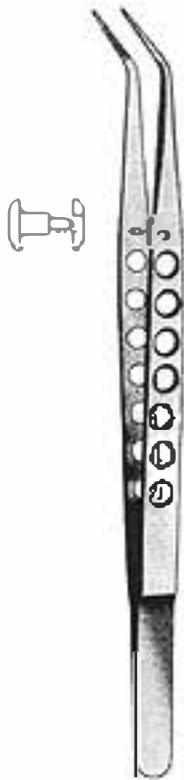

02-024-15  
15 cm



02-025-15  
15 cm



02-026-15  
15 cm



TWEEZI  
ZHAN PINZ  
PINZA

02

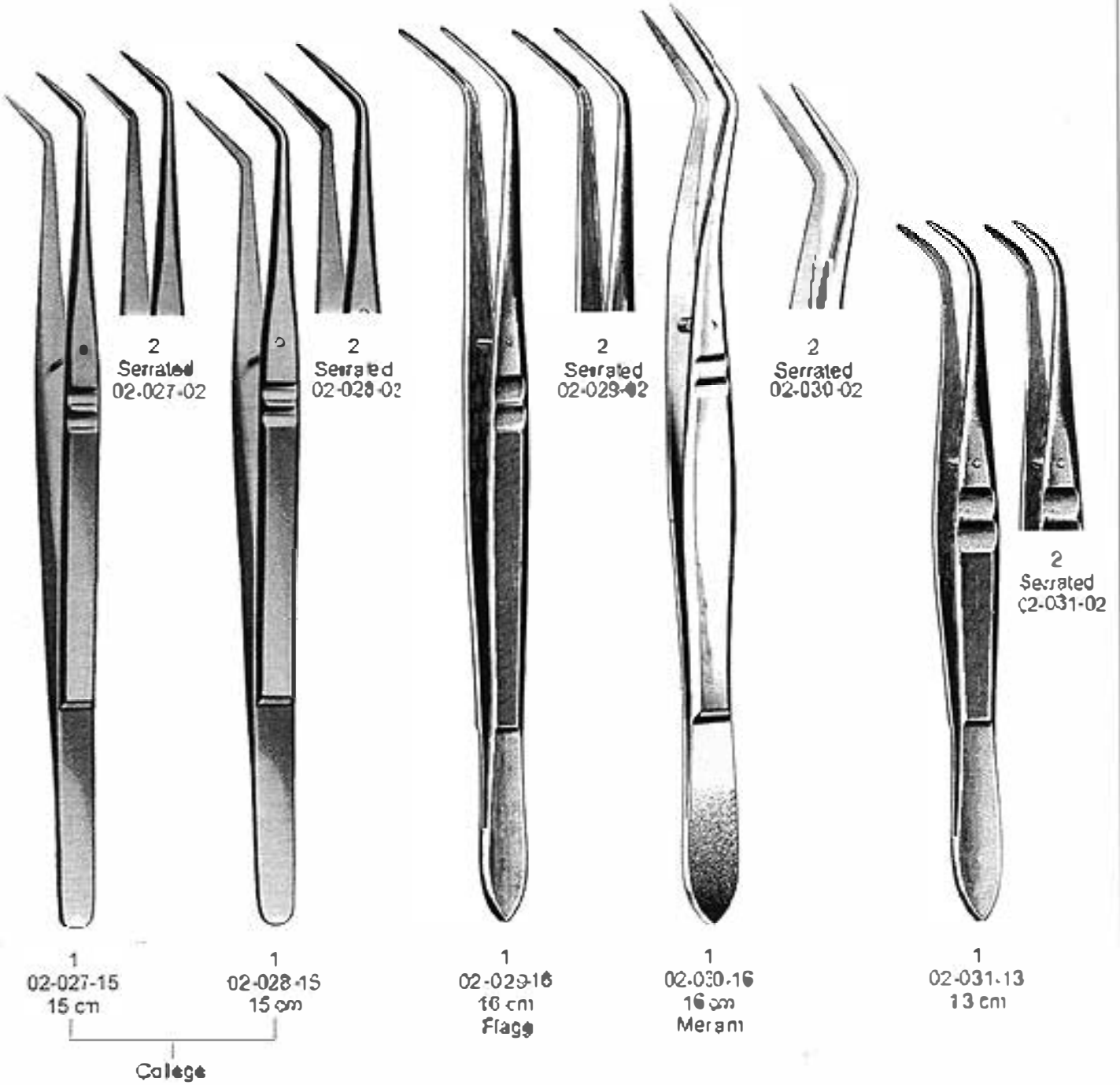

DRESSING AND DISSECTING FORCEPS -  
SUTURE TWEEZERS  
PINCES A DISSECTION - PINCES DE SUTURE  
PINZAS DE DISECCION - PINZAS DE SUTURA

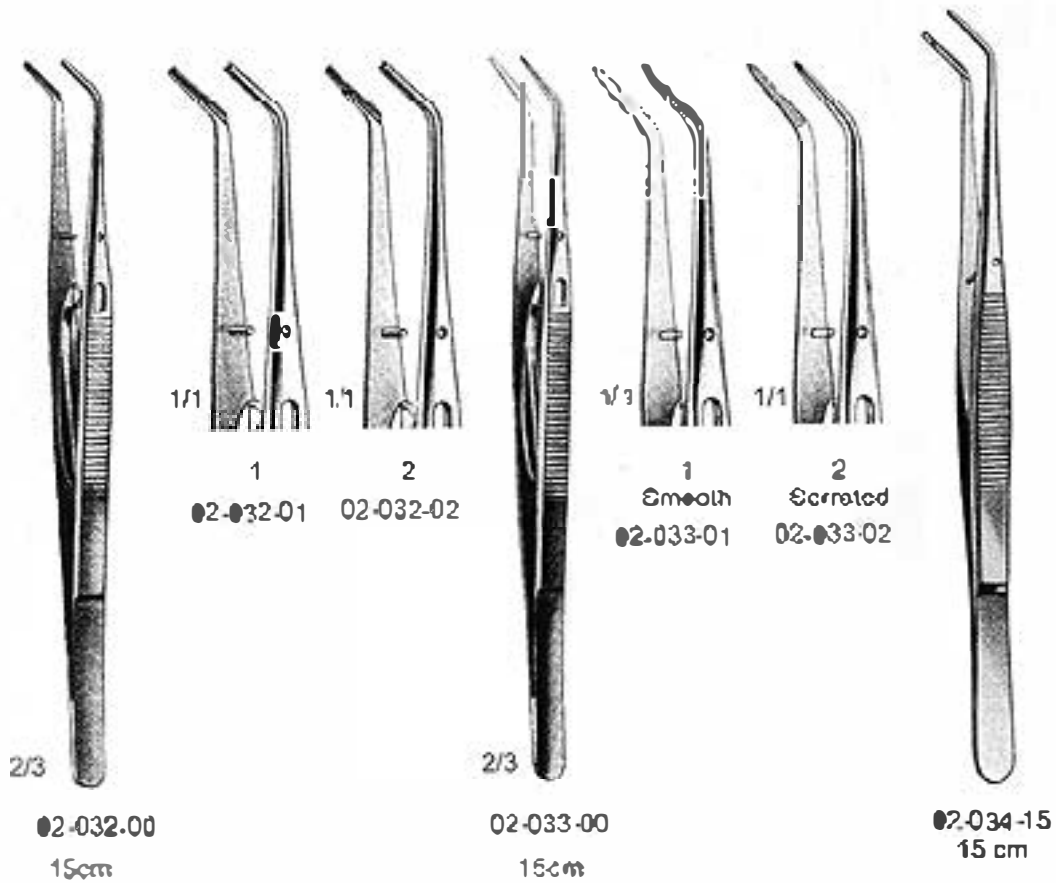



02-085-15  
15.5 cm  
Amsterdam



02-086-15  
15.5 cm  
Tietzes



02-087-15  
15 cm



02-088-15  
15 cm

Gillies

2:1



02-089-13  
13 cm



02-090-13  
13 cm

2:1

TISSUE FORCEPS  
CHIRURGISCHE PINZETTEN  
PRECELLES CHIRURGICALES

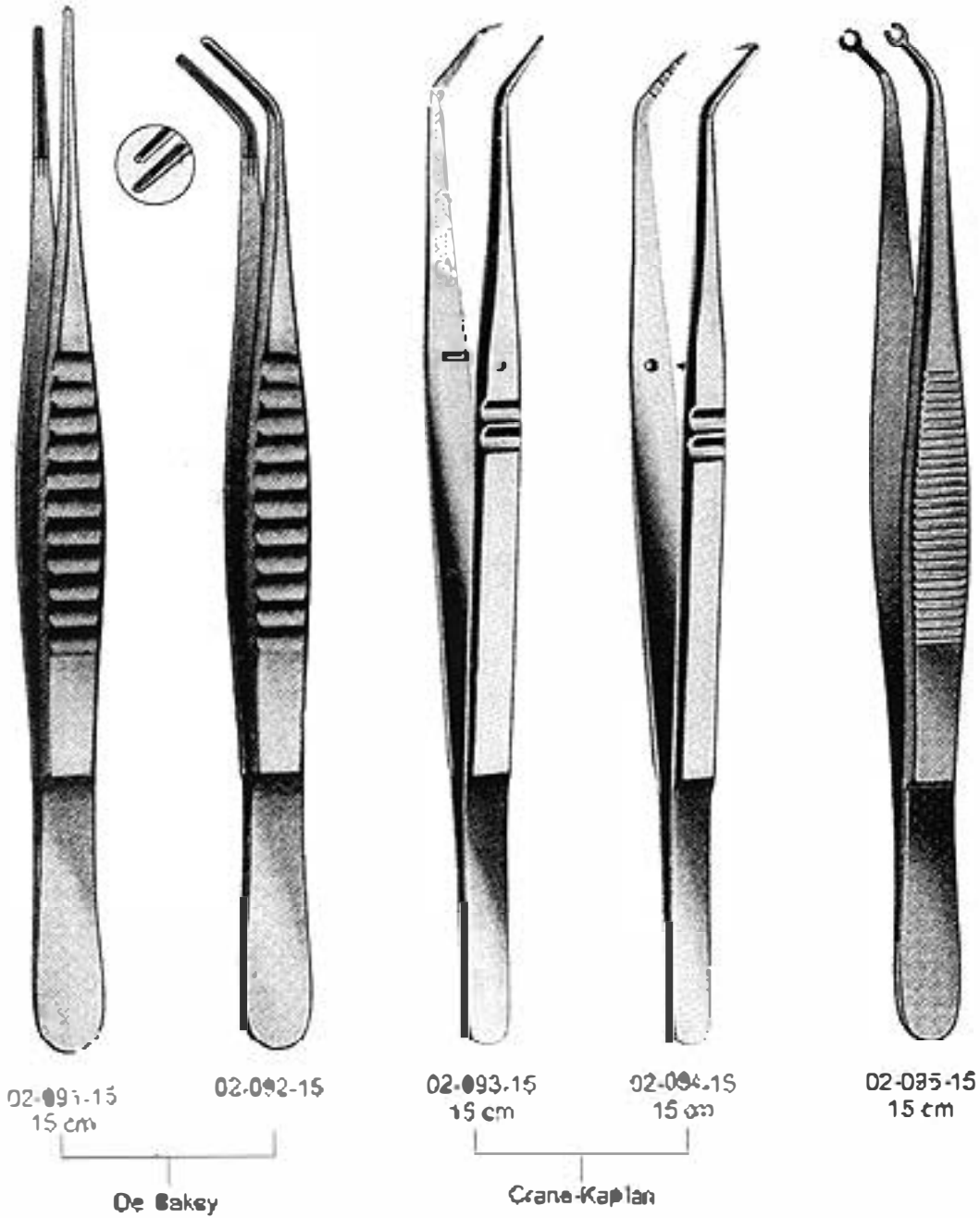



DRESSING FORCEPS  
INSTRUMENTS ANATOMISCHE PINZETTEN  
PINZAS DE DISECCION

02



02-146-00  
Standard

1	2	3	4	5	6	7	8
11 cm	13 cm	14.5 cm	16 cm	18 cm	20 cm	25 cm	30 cm
02-146-01	02-146-02	02-146-03	02-146-04	02-146-05	02-146-06	02-146-07	02-146-08



02-147-00  
Standard

1	2	3	4	5	6	7	8	9
10.5 cm	10.5 cm	13 cm	14.5 cm	16 cm	18 cm	20 cm	25 cm	30 cm
02-147-01	02-147-02	02-147-03	02-147-04	02-147-05	02-147-06	02-147-07	02-147-08	02-147-09

DRESSING FORCEPS  
INSTRUMENTS ANATOMISCHE PINZETTEN  
PINZAS DE DISECCION

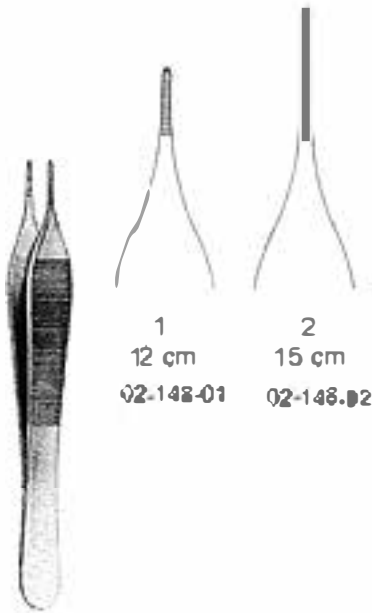

1  
12 cm  
02-148-01

2  
15 cm  
02-148-02

02-148-15  
Adson

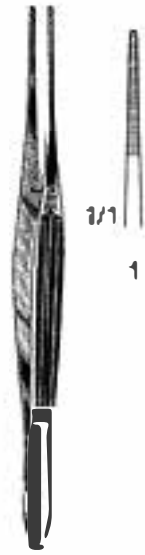

1/1  
1

02-149-15  
15 cm  
McIndoe



1  
12 cm  
02-149-01

2  
13 cm  
02-149-02

3  
14.5 cm  
02-149-03

4  
15 cm  
02-149-04

02-149-15  
Gracile



1  
12 cm  
02-151-01

2  
13 cm  
02-151-02

3  
14.5 cm  
02-151-03

4  
15.5 cm  
02-151-04

5  
18 cm  
02-151-05

6  
21 cm  
02-151-06

7  
25 cm  
02-151-07

8  
31 cm  
02-151-08

02-151-09  
Standard



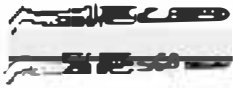

02-152-00  
 Mod Martin



02-153-00  
 15 cm  
 Stile



02-154-00



02-155-00

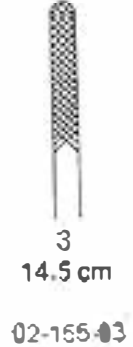
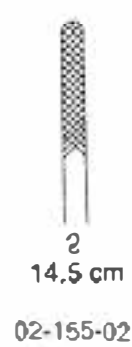
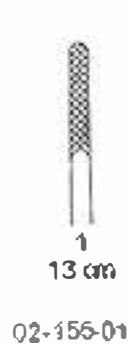

02

INST

# G FORCEPS TOMISCHE PINZETTEN E DISECCION



02-156-00  
Potts Smith



1  
18 cm  
02-156-01



2  
21 cm  
02-156-02



3  
25 cm  
02-156-03



02-157-18  
18 cm  
Gerald



02-157-18  
18 cm



02-158-18  
18 cm



02-159-17  
17.5 cm



02-159-17  
17.5 cm



02-160-17  
17.5 cm



DRESSING FORCEPS  
INSTRUMENTS ANATOMICAL  
PINZAS DE D

ET EN

02

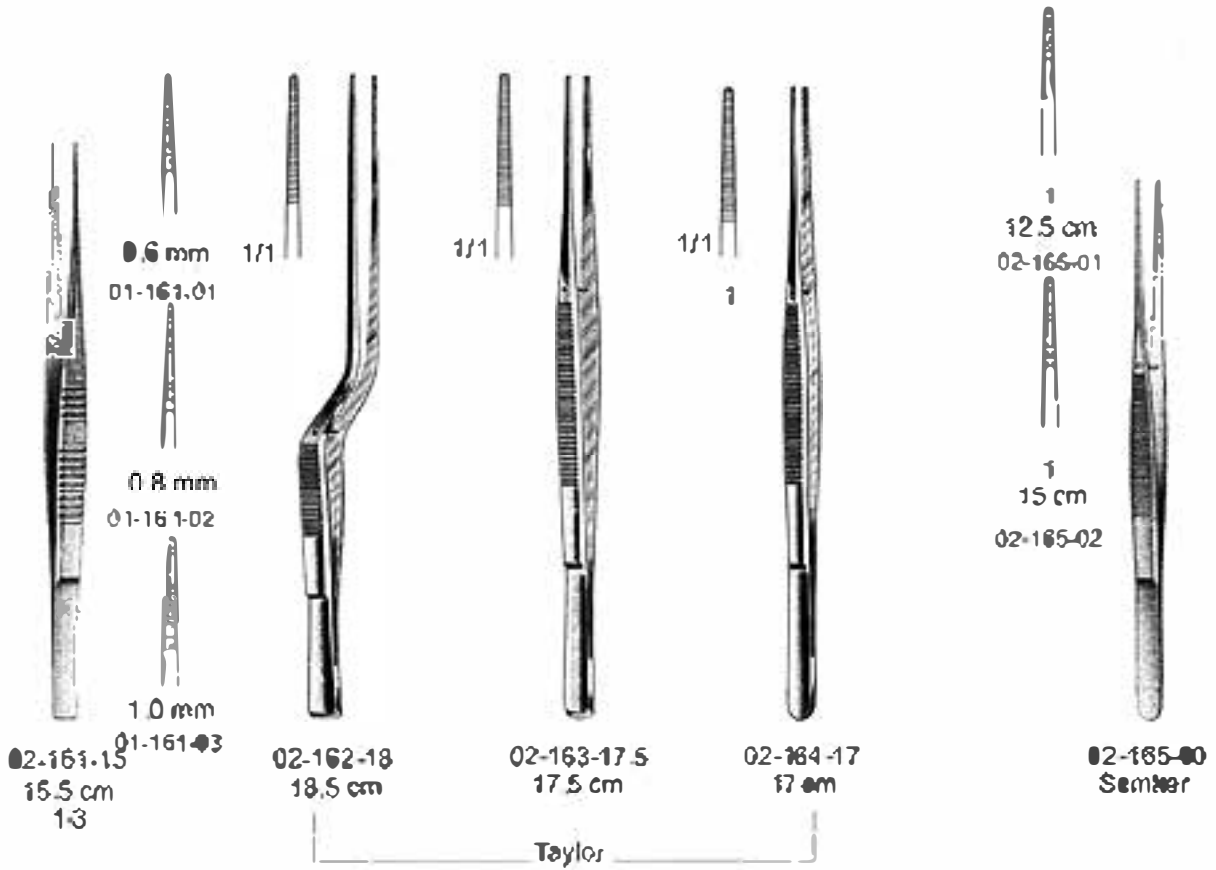

DRESSING FORCEPS  
 INSTRUMENTS ANATMISCHE PINZETTEN  
 PINZAS DE DISECCION



02-166-00  
 1x2 Teeth

1	2	3	4	5	6	7	8	9
10.5 cm	11.5 cm	13 cm	14.5 cm	16 cm	18 cm	20 cm	25 cm	30 cm
02-166-01	02-166-02	02-166-03	02-166-04	02-166-05	02-166-06	02-166-07	02-166-08	02-166-09



02-167-00  
 2x3 Teeth

1	2	3	4	5	6	7
11.5 cm	13 cm	14.5 cm	18 cm	18 cm	20 cm	25 cm
02-167-01	02-167-02	02-167-03	02-167-04	02-167-05	02-167-06	02-167-07

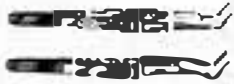

DRESSING FORCEPS  
INSTRUMENTS ANATOMISCHE PINZETTEN  
PINZAS DE DISECCION

02



02-168-00  
1x2 Teeth  
1-2



1  
13 cm  
02-168-01



2  
14 cm  
02-168-02



02-169-00  
1x2 Teeth  
1-4



1  
13 cm  
02-169-01



2  
14 cm  
02-169-02



3  
16 cm  
02-169-03



4  
20 cm  
02-169-04



02-170-00  
4x5 Teeth  
1-3



1  
13 cm  
02-170-01



2  
14.5 cm  
02-170-02



3  
16 cm  
02-170-03



02-171-00  
3x4 Teeth  
1-3



1  
13 cm  
02-171-01



2  
14.5 cm  
02-171-02











3  
16 cm  
02-171-03

DRESSING FORCEPS  
INSTRUMENTS ANATMISCHE PINZET EN  
PINZAS DE DISECCION



02-172-00  
Mod U.S.A  
1.S

							
1	2	3	4	5	6	7	8
12 cm	13 cm	14.5 cm	15.5 cm	16.5 cm	21 cm	25 cm	31 cm
02-172-01	02-172-02	02-172-03	02-172-04	02-172-05	02-172-06	02-172-07	02-172-08



02-173-15  
15 cm  
Stille  
1x2 Teeth



1/1



02-174-15  
15 cm  
Stille  
2x2 Teeth



1/1



02-175-00  
Mod Martin  
1x2 Teeth



1  
13 cm  
02-175-01



1  
14.5 cm  
02-175-02

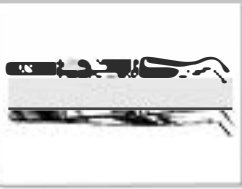

02-176-08  
 8 cm



02-177-09  
 9 cm



02-178-08  
 8 cm  
 Felkoenfeld



02-179-10  
 10.5 cm



02-180-10  
 10.5 cm

Hunter



# TUNGSTEN CARBIDE INSERTS



02-231-12  
12 cm  
Adson

02-232-12 02-233-15  
12 cm 15 cm  
Semken

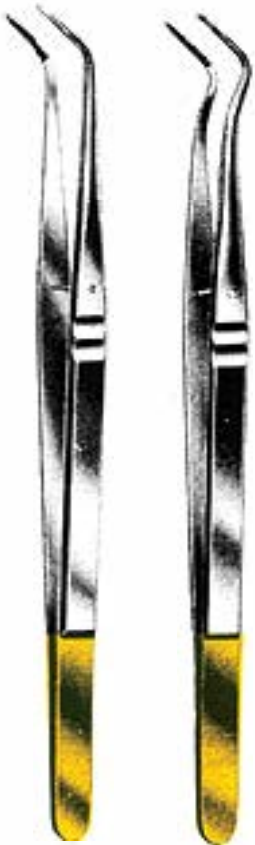

02-233-15  
15 cm  
College

02-234-15  
15 cm  
Mariani



02-235-15  
15 cm  
Potts-Smith



02-236-15  
15 cm  
Standard



02-237-15  
15 cm  
Mariani

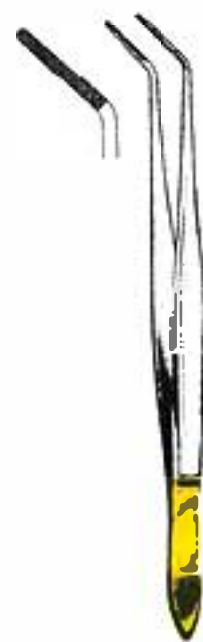

02-238-15  
15 cm  
Cushing



Department

03

PERIOSTEAL ELEVATORS  
RASPATORIEN UND ELEVATORIEN  
PERIOSTOTOMOS

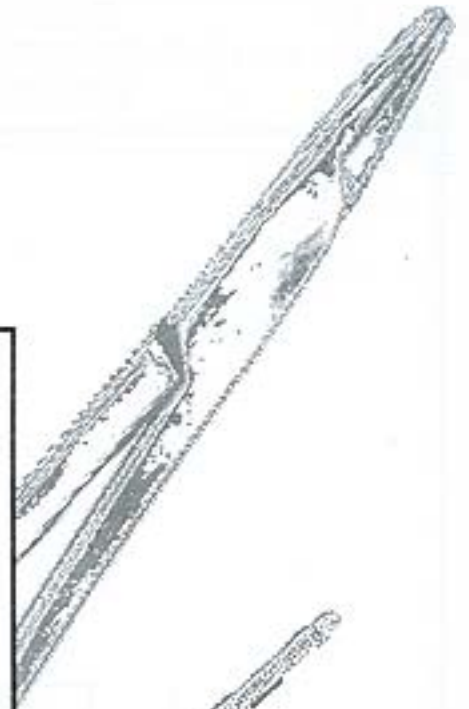
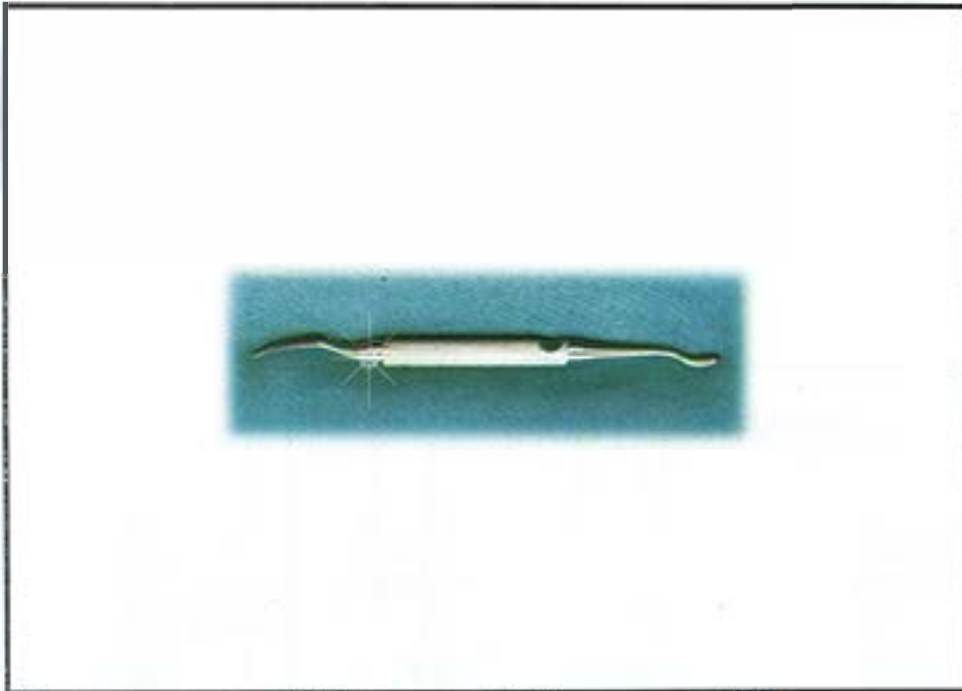

DEPARTMENT NO. 3

FROM  
PAGE#

39

TO  
PAGE#

46

INSTRUMENTS CATEGORY

PERIOSTEAL ELEVATORS  
RASPATORIEN UND ELEVATORIEN  
PERIOSTOTOMOS



PERIOSTEAL ELEVATORS  
 RASPATORIEN UND ELEVATORIEN  
 PERIOSTOTOMOS

03



03-001-17  
 17 cm  
 Kondziq



03-002-18.5  
 18.5 cm  
 Freer

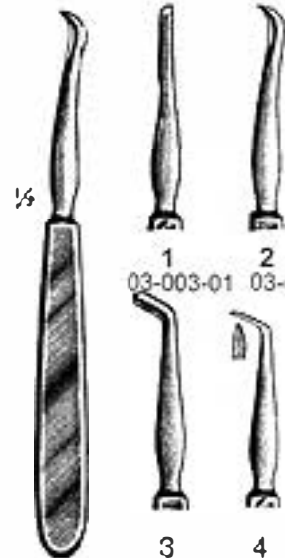

03-003-15  
 15 cm  
 Champret

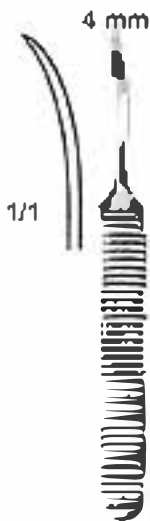
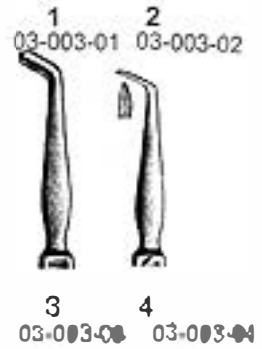

03-004-14  
 14 cm



03-005-17  
 17.5 cm



03-006-16  
 16.5 cm



03-007-16  
 16 cm

Willinger

# PERIOSTEAL ELEVATORS RASPATORIEN UND ELEVATORIEN PERIOSTOTOMOS

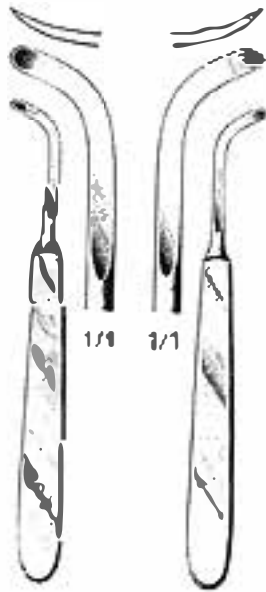
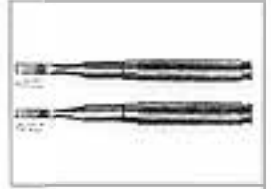

03-008-14  
14 cm  
Left

03-009-14  
14 cm  
Right

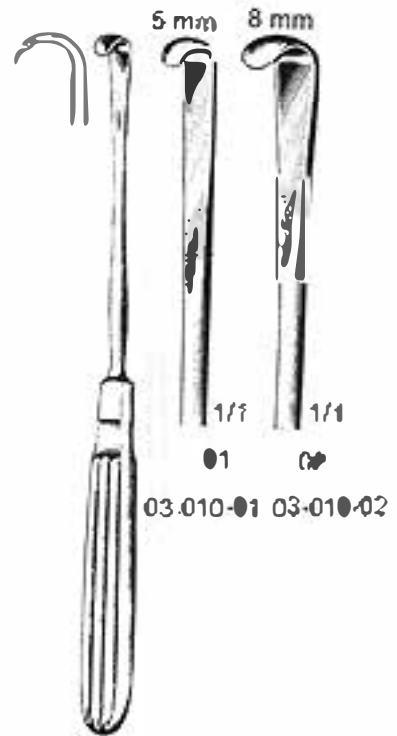

03-010-20  
20 cm



03-011-18  
18.5 cm  
Freer-Yasargil



03-012-20  
20 cm  
Sewall



03-013-14  
14 cm  
Traub



PERIOSTEAL ELEVATORS  
 RASPATORIEN UND ELEVATORIEN  
 PERIOSTOTOMOS



03-014-18  
 18 cm  
 Mehl

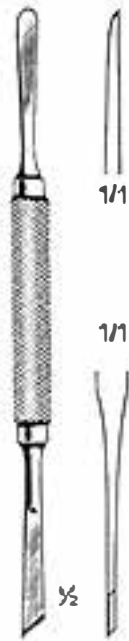

03-015-16  
 16.5 cm  
 Mead



03-016-16  
 16 cm  
 Freer

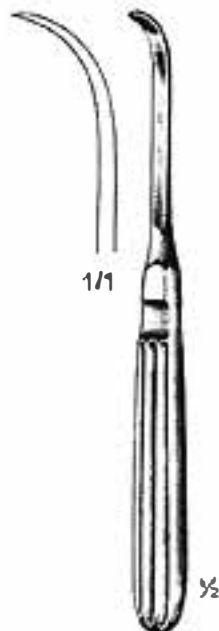

03-017-17  
 03-018-17 (6mm)  
 17 cm



03-019-16  
 16 cm  
 Joseph



03-020-17  
 17 cm

CHISELS AND GOUGES  
BURINS ET GOUGES  
CINCELES Y GUBIAS

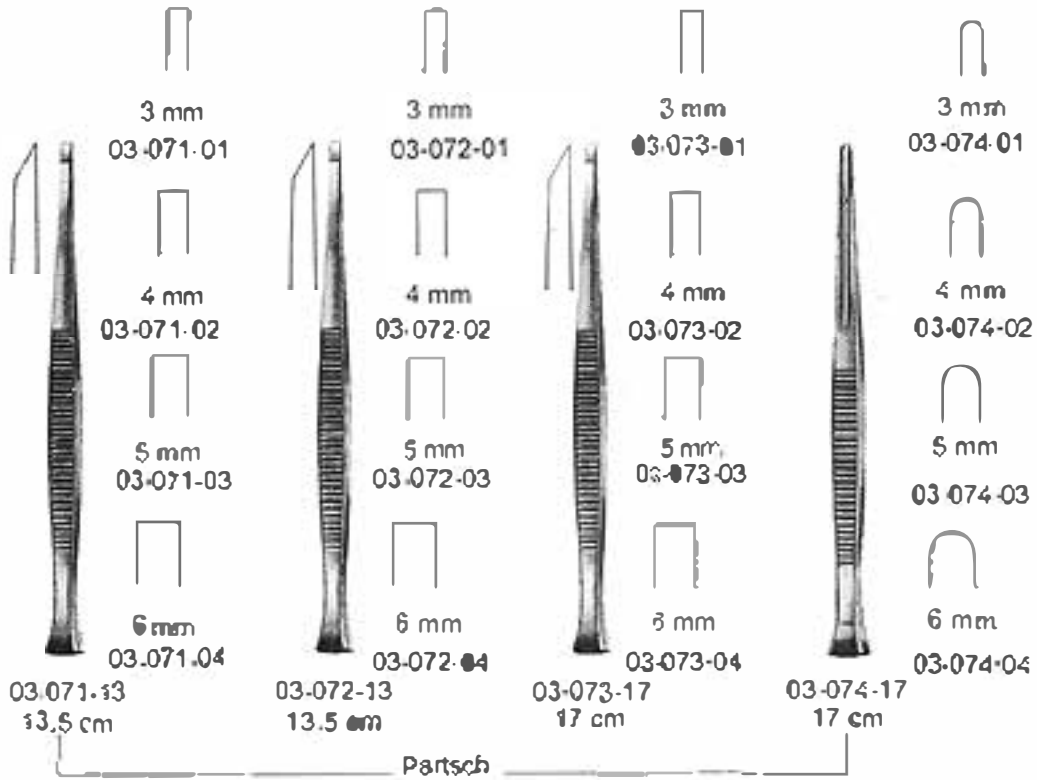

Partsch

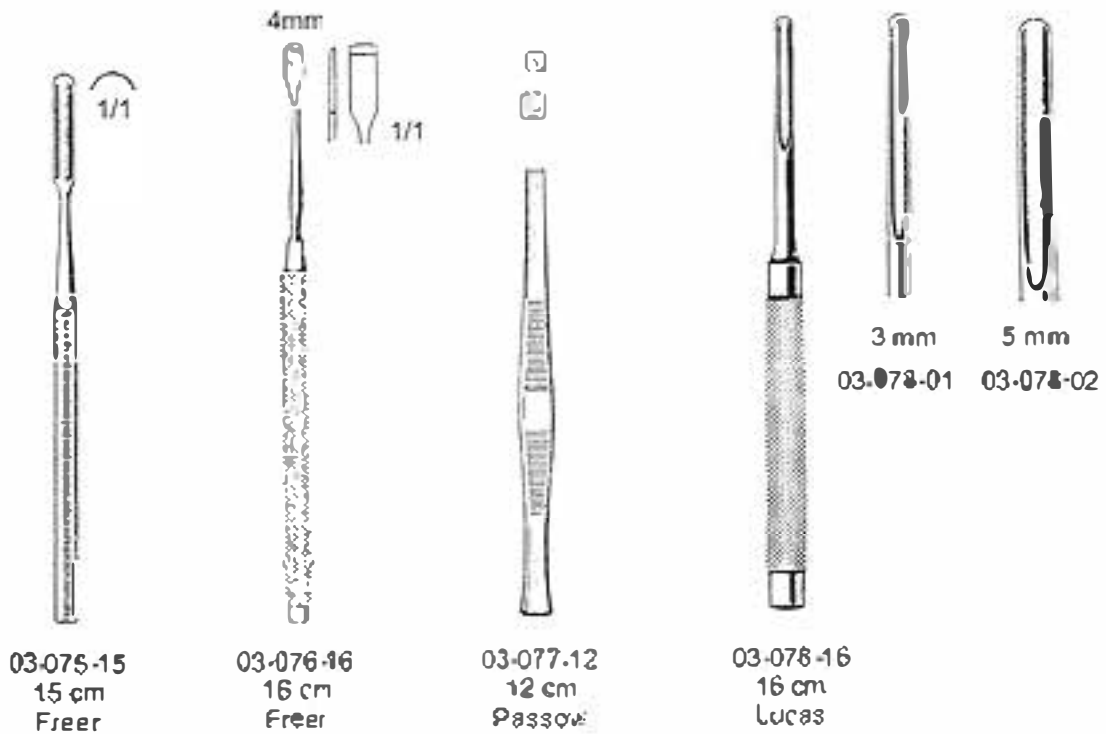

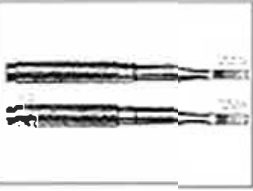

03-079-00 03-080-00 03-081-00 03-082-00 03-083-00 03-084-00 03-085-00 03-086-00 03-087-00 03-088-00  
 [Ochsenbein] Gardner [Waketield] Buckley

BONE FILES  
LIMES A OS  
LIMAS PARA HUESOS



2

3

03-139 00  
Miser. Colburn

03-139 01

03-139 02

03-139 03

03-139-04



1

2

4



03-140.01

03-140.02

03-140 03

03-140-04

03-140-00



Department

04

EXTRACTING FORCEP, ENGLISH PATTERN  
ZAHNANGEN, ENGLISCHE FORM  
FORCEPS DE EXTRACCIÓN, FORMA ECGLESA

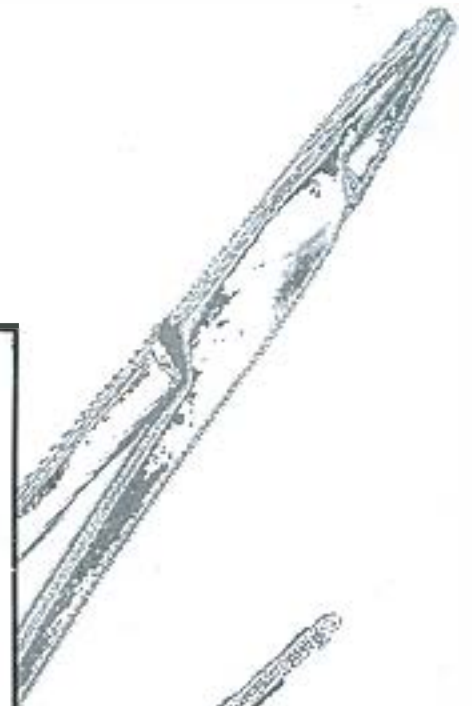

**Uppers**

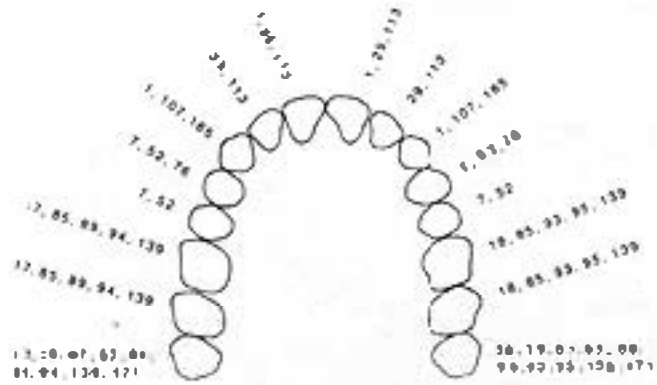

**ADULTS**

**Lowers**

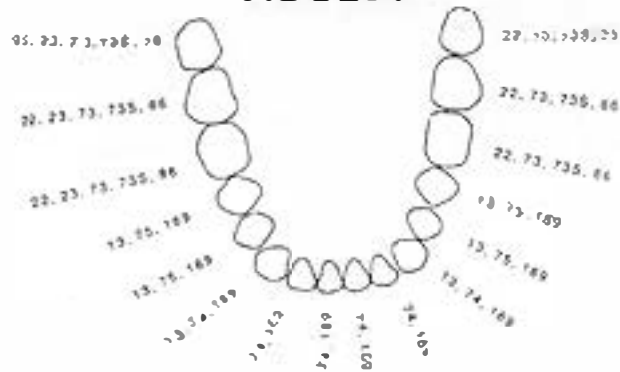

**Children's Uppers**

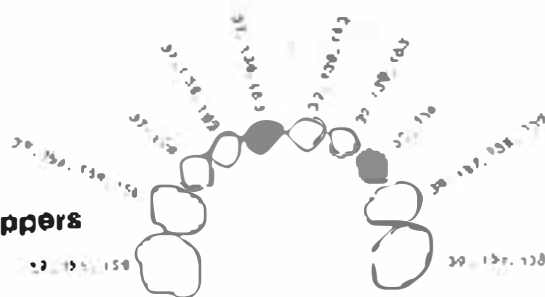

**CHILDREN**

**Children's Lower**

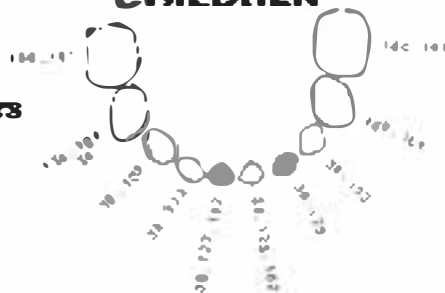

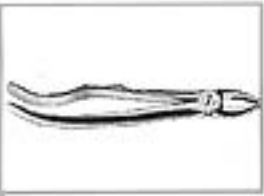

EXTRACTING FORCEPS, ENGLISH PATTERN  
 ZAHNZANGEN, ENGLISCHE FORM  
 FORCEPS DE EXTRACCION, FORMA ENGLISA



1  
 04-001-00



2  
 04-002-00



2B  
 04-003-00



7  
 04-004-00



27  
 04-005-00



27B  
 04-006-00



EXTRACTING FORCEPS, ENGLISH PATTERN  
ZAHNZANGEN, ENGLISCHE FORM  
FORCEPS DE EXTRACCION, FORMA ENGLESA

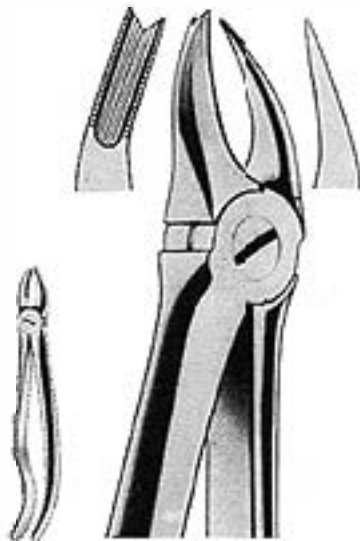

66 R  
04-007-00



66 L  
04-008-00

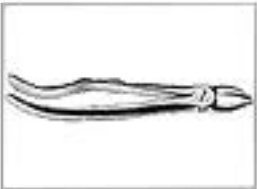

EXTRACTING FORCEPS, ENGLISH PATTERN  
 ZAHNZANGEN, ENGLISCHE FORM  
 FORCEPS DE EXTRACCION, FORMA ENGLESA

04



85  
04-010-00



13  
04-011-00



28  
04-012-00



23  
04-013-00



22  
04-014-00



78  
04-015-00



79  
04-016-00

EXTRACTING FORCEPS, ENGLISH PATTERN  
ZAHNZANGEN, ENGLISCHE FORM  
FORCEPS DE EXTRACCION, FORMA ENGLESA

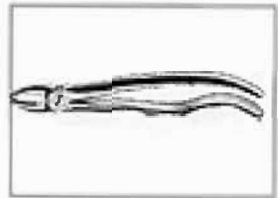

97  
04-017-00



59  
04-018-00



74  
04-019-00

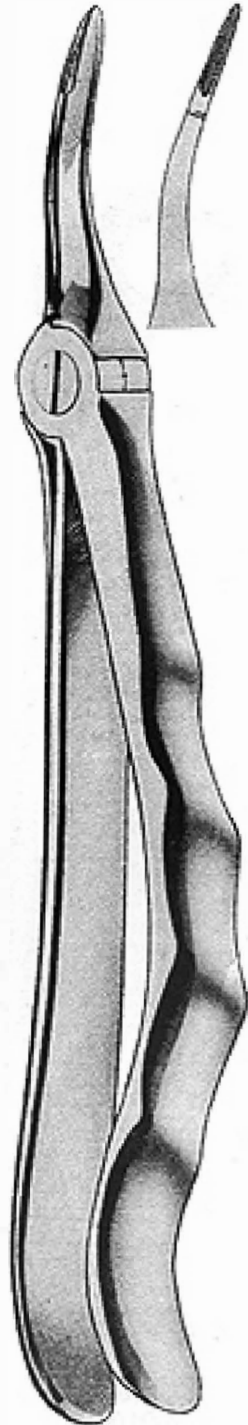

49  
04-023-00

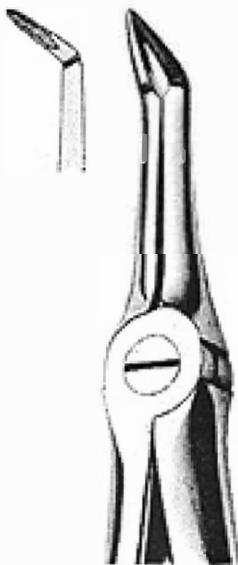

46  
04-020-00

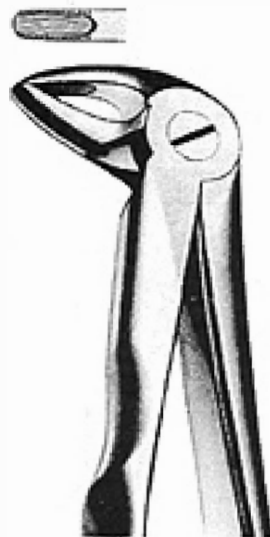

33  
04-021-00



33 A  
04-022-00

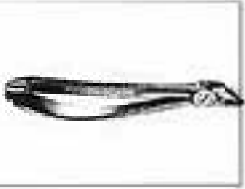

EXTRACTING FORCEPS, ENGLISH PATTERN  
 ZAHNZANGEN, ENGLISCHE FORM  
 FORCEPS DE EXTRACCION, FORMA ENGLESA

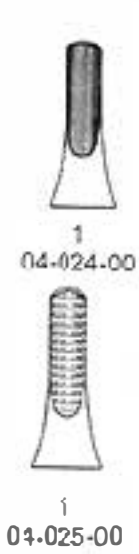

1  
04-024-00

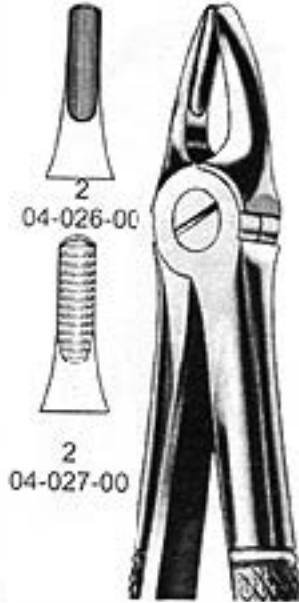

2  
04-026-00



3  
04-028-00

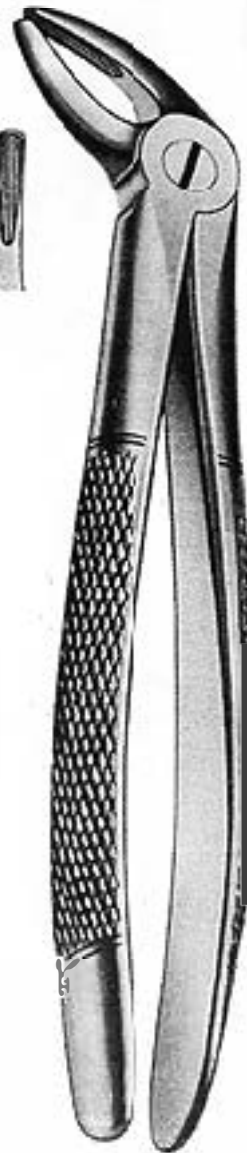

4  
04-029-00

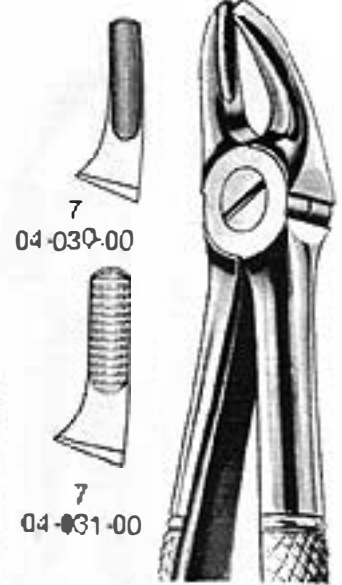

7  
04-030-00



8  
04-032-00

EXTRACTING FORCEPS, ENGLISH PATTERN  
ZAHNZANGEN, ENGLISCHE FORM  
FORCEPS DE EXTRACCION, FORMA ENGLESA

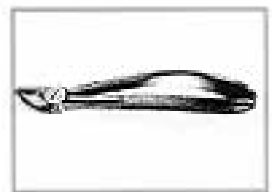

17  
04-036-00  
Right

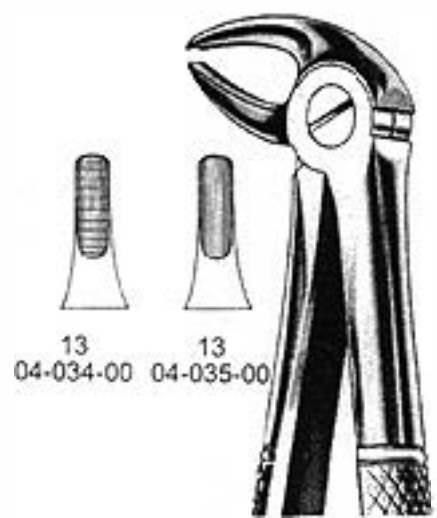

13 13  
04-034-00 04-035-00

13  
04-034-00

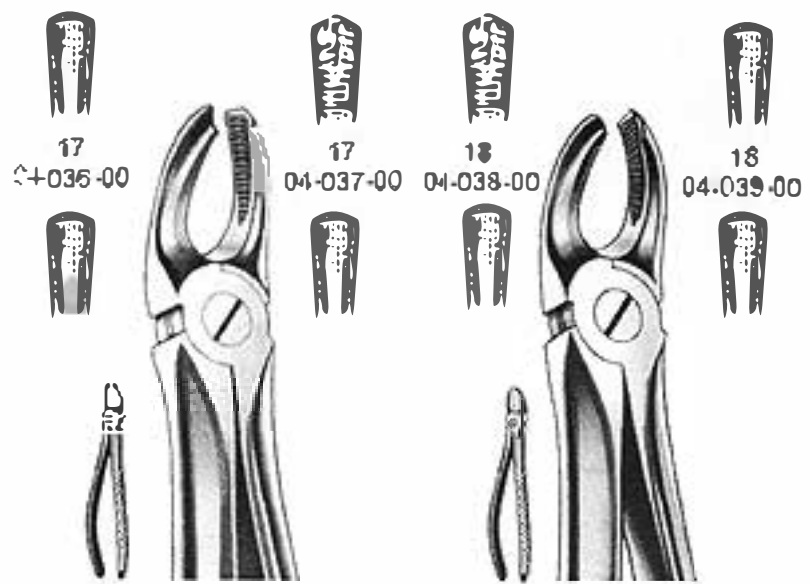

17  
04-036-00

17  
04-037-00

18  
04-038-00

18  
04-039-00

17  
04-035-00  
Right

18  
04-038-00  
Left





EXTRACTING FORCEPS, ENGLISH PATTERN  
 ZAHNZANGEN, ENGLISCHE FORM  
 FORCEPS DE EXTRACCION, FORMA ENGLESA



20  
 04-040-00  
 Molaron

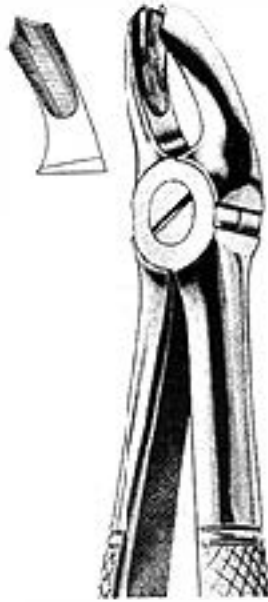

18 A  
 04-041-00

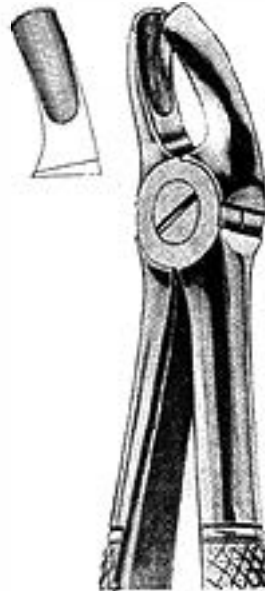

18 B  
 04-042-00



19  
 04-043-00



21  
 04-044-00



22  
 04-045-00



22 G  
 04-046-00

EXTRACTING FORCEPS, ENGLISH PATTERN  
ZAHNZANGEN, ENGLISCHE FORM  
FORCEPS DE EXTRACCION, FORMA ENGLESA

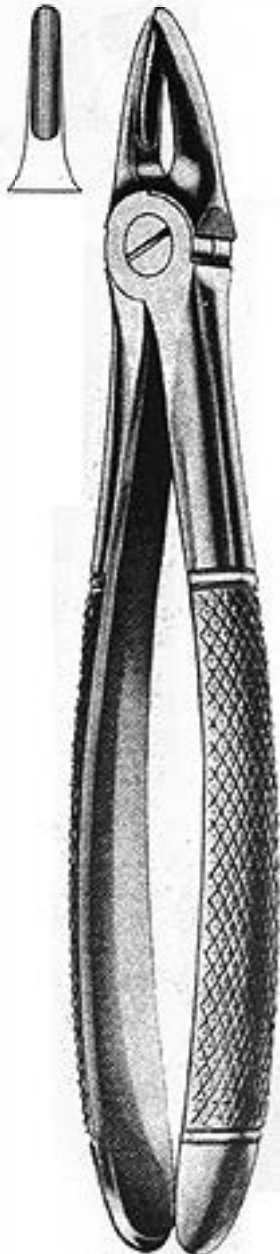

29  
04-047-00



29 S  
04-048-00

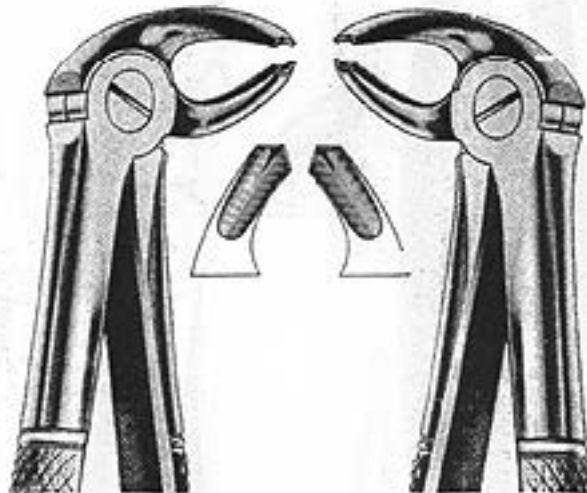

23  
04-049-00  
Right

24  
04-050-00  
Left



EXTRACTING FORCEPS, ENGLISH PATTERN  
ZAHNZANGEN, ENGLISCHE FORM  
FORCEPS DE EXTRACCION, FORMA ENGLESA



30  
04-051-00

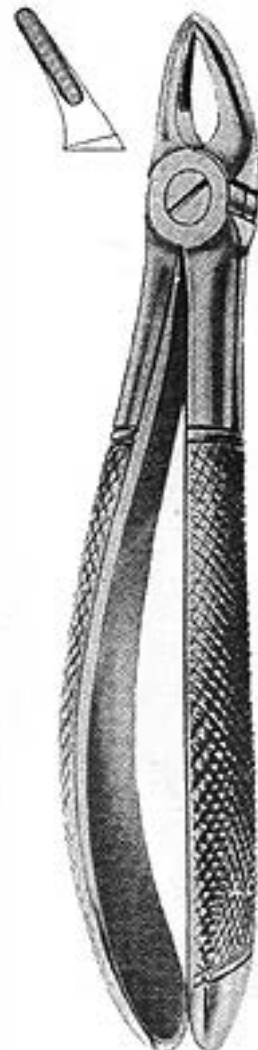

30 S  
01-054-00

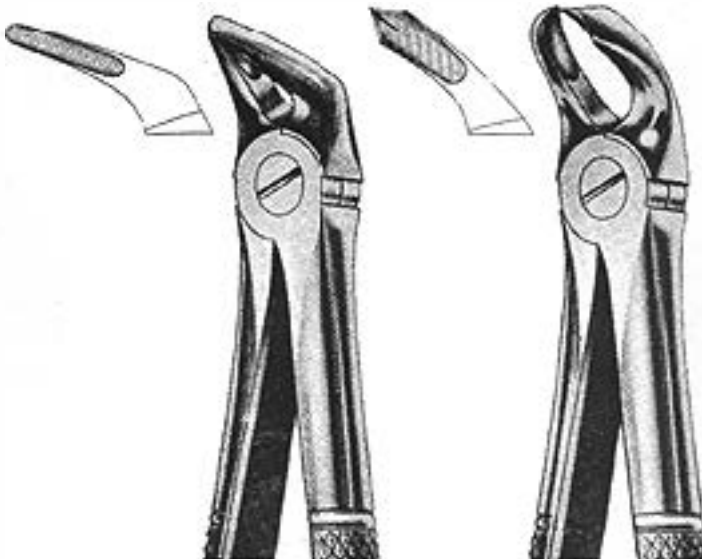

31  
01-052-00

32  
04-053-00

EXTRACTING FORCEPS, ENGLISH PATTERN  
ZAHNZANGEN, ENGLISCHE FORM  
FORCEPS DE EXTRACCION, FORMA ENGLESA

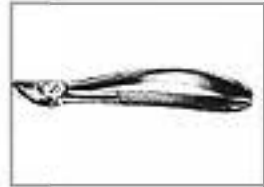

33  
04-055-00



33 S  
04-056-00



33 A  
04-057-00



33 B  
04-058-00



33 L  
01-059-00



EXTRACTING FORCEPS, ENGLISH PATTERN  
 ZAHNZANGEN, ENGLISCHE FORM  
 FORCEPS DE EXTRACCION, FORMA ENGLESA.

04



39 L  
04-060.00

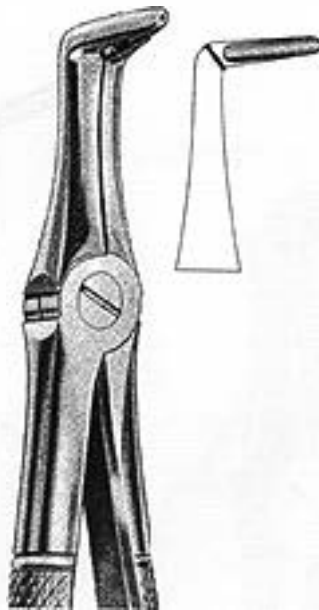

45  
04-061-00

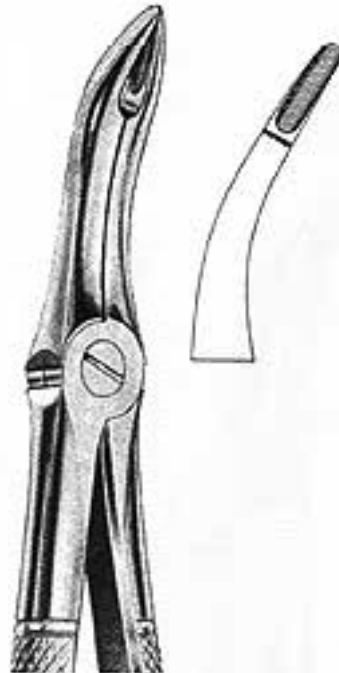

44  
04-062-00



39 A  
04-063 00



39 R  
04-064.00

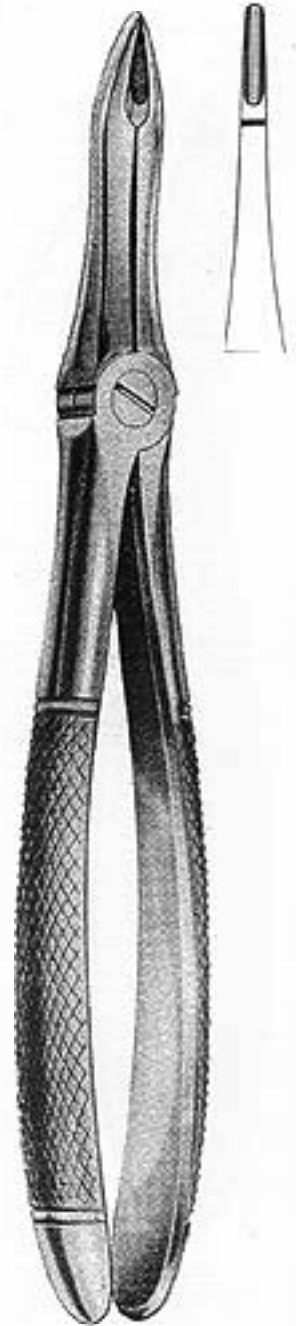

41  
04-065.00

EXTRACTING FORCEPS, ENGLISH PATTERN  
 ZAHNZANGEN, ENGLISCHE FORM  
 FORCEPS DE EXTRACCION, FORMA ENGLESA



48  
 04-066-00



49  
 01-067-00

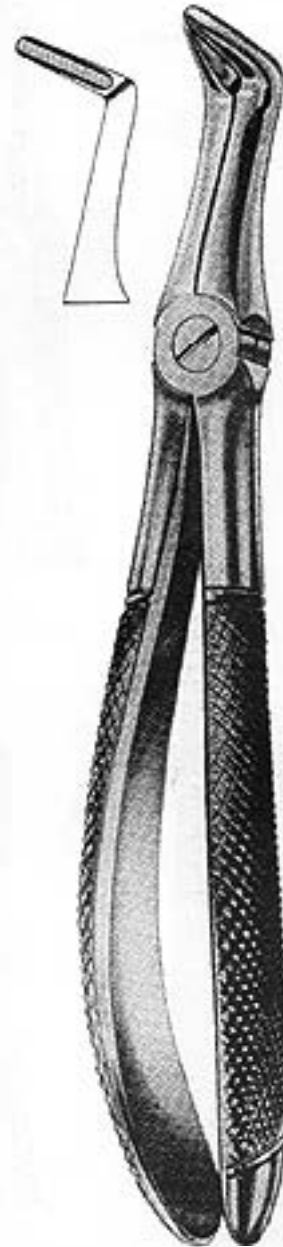

50  
 04-068-00



EXTRACTING FORCEPS,  
ZAHNZANGEN, ENG  
FORCEPS DE EXTRACCIO



52  
04-069-00

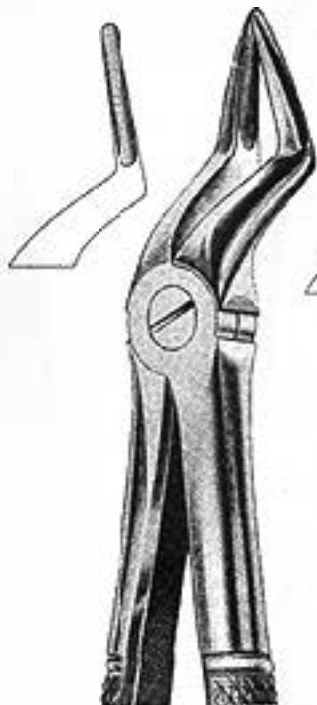

51A  
04-070-00



51L  
04-071-00

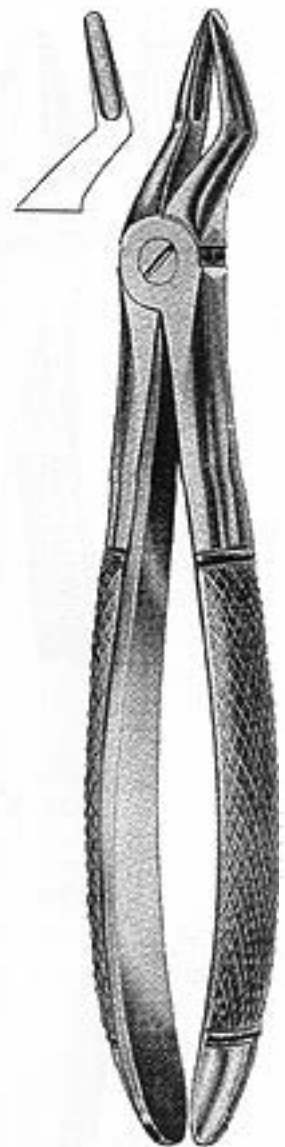

51 S  
04-072-00

EXTRACTING FORCEPS, ENGLISH PATTERN  
ZAHNZANGEN, ENGLISCHE FORM  
FORCEPS DE EXTRACCION, FORMA ENGLISA

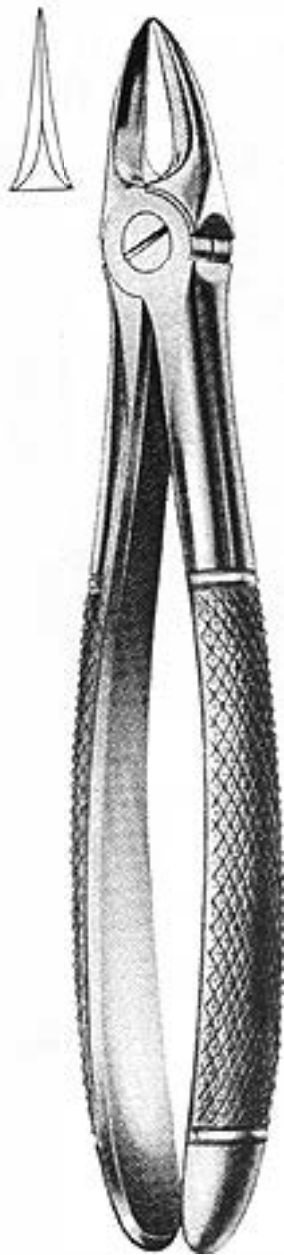

54  
04-073-00

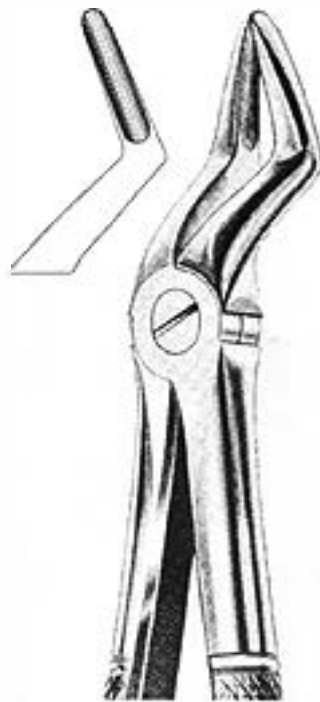

51  
04-074-00

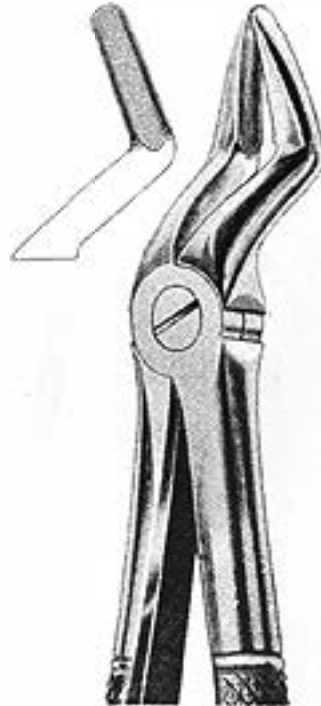

52 A  
04-075-00



55  
04-076-00



56  
04-077-00





EXTRACTING FORCEPS, ENGLISH PATTERN  
 ZAHNZANGEN, ENGLISCHE FORM  
 FORCEPS DE EXTRACCION, FORMA ENGLESA



67 1/2 L  
 04-078-00

67 1/2 L  
 04-078-0C



67 1/2 L  
 04-078-00



67 1/2 R  
 04-081-00

67 1/2 R  
 04-081-00



67 1/2 R  
 04-081-00

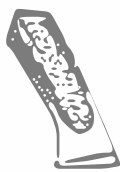

65 R  
 04-079-00



65 L  
 04-080-00

EXTRACTING FORCEPS, ENGLISH PATTERN  
ZAHNZANGEN, ENGLISCHE FORM  
FORCEPS DE EXTRACCION, FORMA ENGLESA

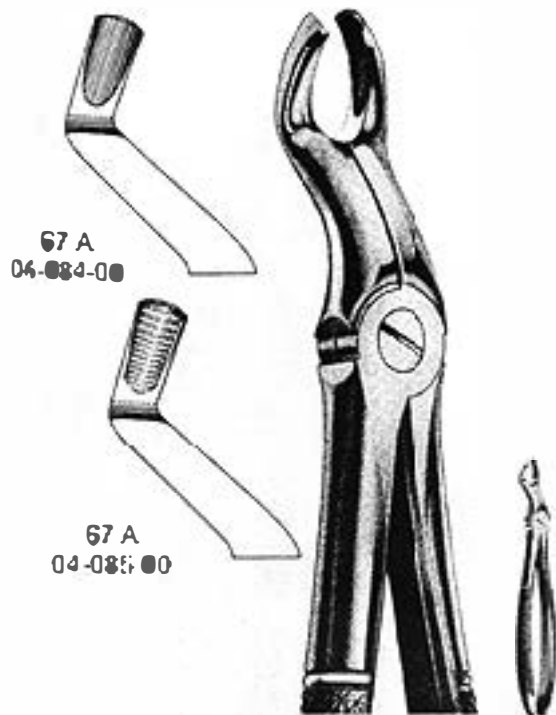
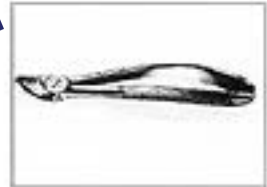

67 A  
04-084-00

67 A  
04-085-00

67 A  
04-084-00

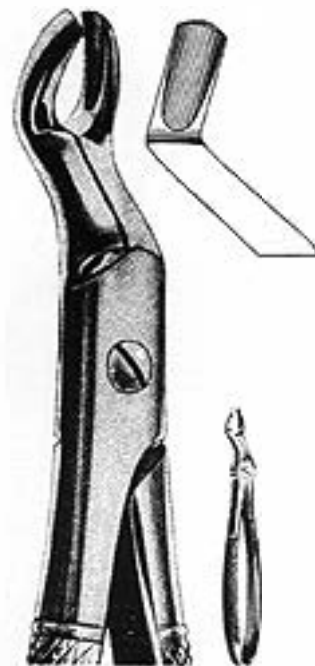

67  
04-086-00



68  
04-087-00



68 A  
04-088-00



EXTRACTING FORCEPS, ENGLISH PATTERN  
ZAHNZANGEN, ENGLISCHE FORM  
FORCEPS DE EXTRACCION, FORMA ENGLESA

04



73 L  
04-091-00



73 A  
04-094-00



73 R  
04-092-00



73  
04-093-00

EXTRACTING FORCEPS, ENGLISH PATTERN  
ZAHNZANGEN, ENGLISCHE FORM  
FORCEPS DE EXTRACCION, FORMA ENGLESA



74 M  
04-095-00

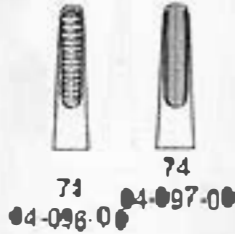

74  
04-098-00  
74  
04-097-00



74  
04-096-00



74 N  
04-098-00



74 D  
04-099-00



75  
04-100-00



EXTRACTING FORCEPS, ENGLISH PATTERN  
 ZAHNZANGEN, ENGLISCHE FORM  
 FORCEPS DE EXTRACCION, FORMA ENGLESA

04

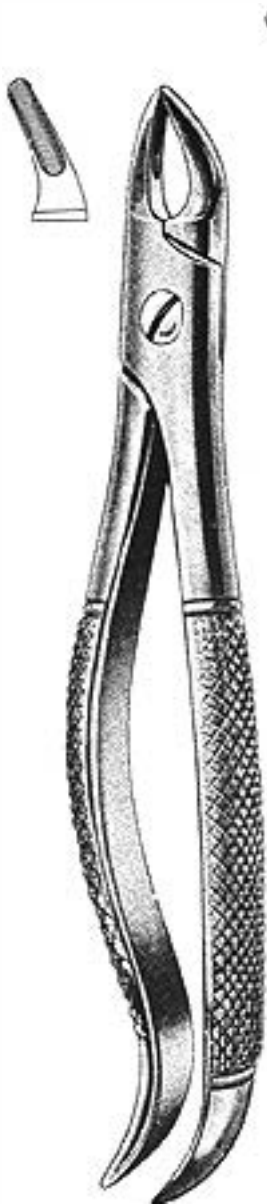

76  
04-101-00



76N  
04-102-00



76S  
04-103-00



79A  
04-104-00



79  
04-105-00

EXTRACTING FORCEPS, ENGLISH PATTERN  
ZAHNZANGEN, ENGLISCHE FORM  
FORCEPS DE EXTRACCION, FORMA ENGLESA

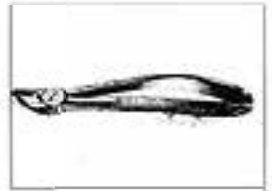

86A  
04-106-00



87  
04-107-00

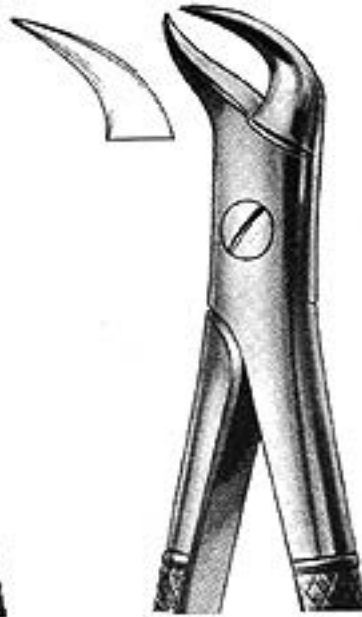

87  
04-108-00



86 B  
04-109-00



86 C  
04-110-00



EXTRACTING FORCEPS, ENGLISH PATTERN  
 ZAHNZANGEN, ENGLISCHE FORM  
 FORCEPS DE EXTRACCION, FORMA ENGLESA

04

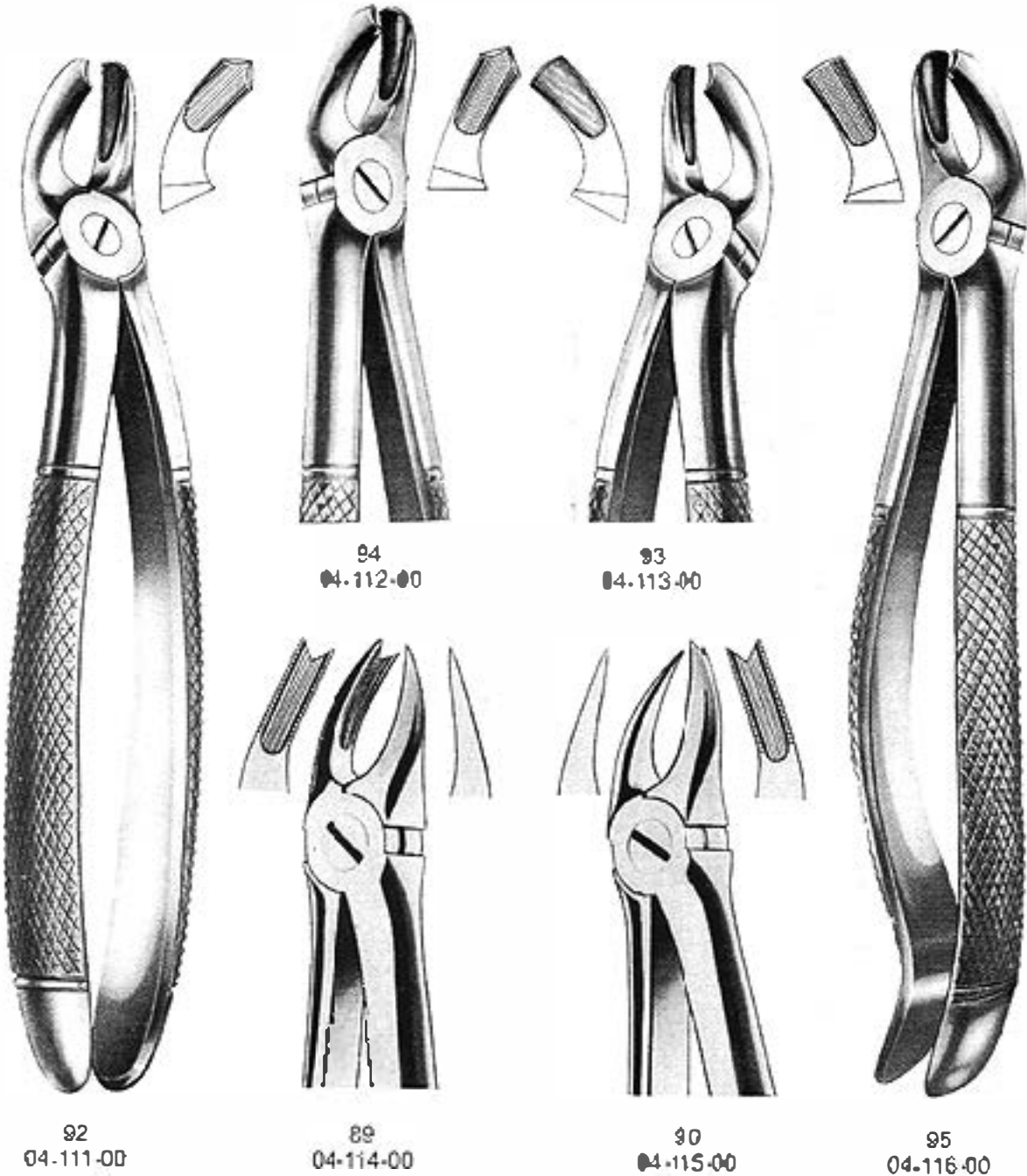

EXTRACTING FORCEPS, ENGLISH PATTERN  
ZAHNZANGEN, ENGLISCHE FORM  
FORCEPS DE EXTRACCION, FORMA ENGLESA

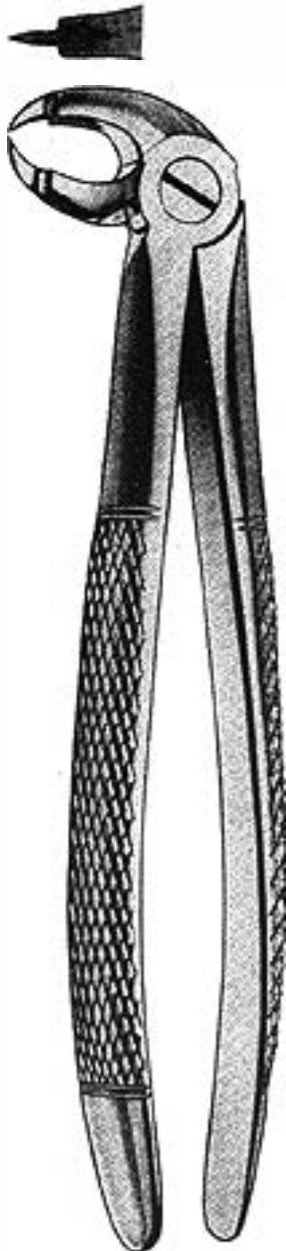

98  
04-117-00



99  
04-118-00



99 1/2  
04-119-00



99 1/4  
04-120-00





EXTRACTING FORCEPS, ENGLISH PATTERN  
 ZAHNZANGEN, ENGLISCHE FORM  
 FORCEPS DE EXTRACCION, FORMA ENGLISA

04

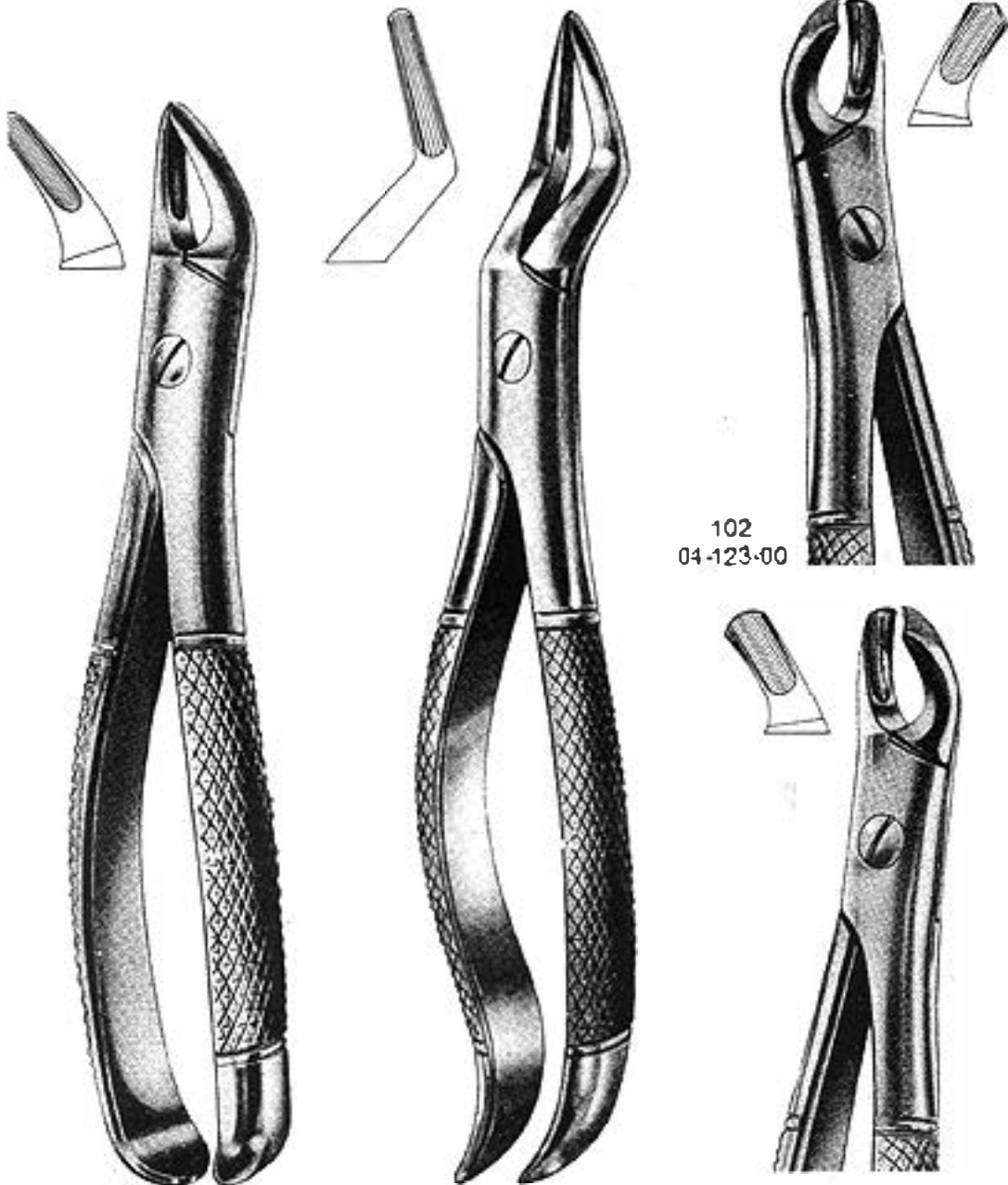

100  
04-121-00

101  
04-122-00

102  
04-123-00

103  
04-124-00

EXTRACTING FORCEPS, ENGLISH PATTERN  
ZAHNZANGEN, ENGLISCHE FORM  
FORCEPS DE EXTRACCION, FORMA ENGLESA

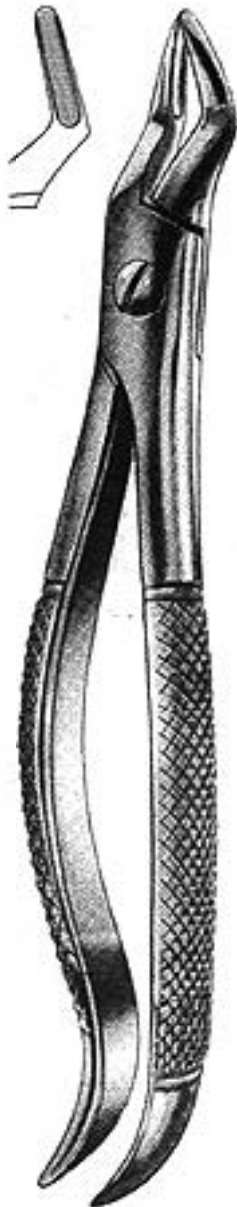

104  
04-125-00



105  
04-126-00



106  
04-127-00

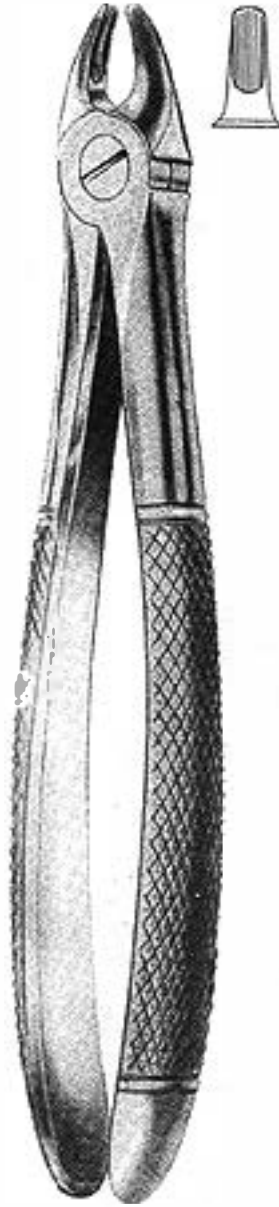

107  
04-128-00



EXTRACTING FORCEPS, ENGLISH PATTERN  
 ZAHNZANGEN, ENGLISCHE FORM  
 FORCEPS DE EXTRACCION, FORMA ENGLESA

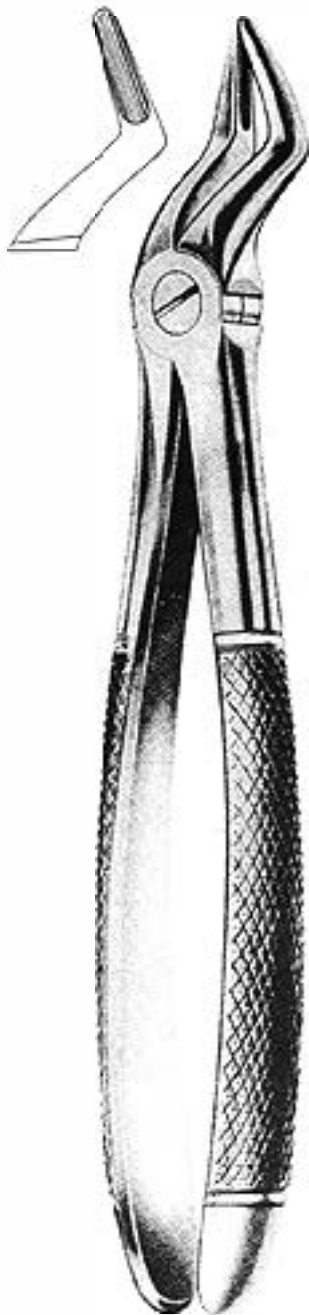

112  
 04-128-00



113  
 04-130-00



114  
 04-131-00

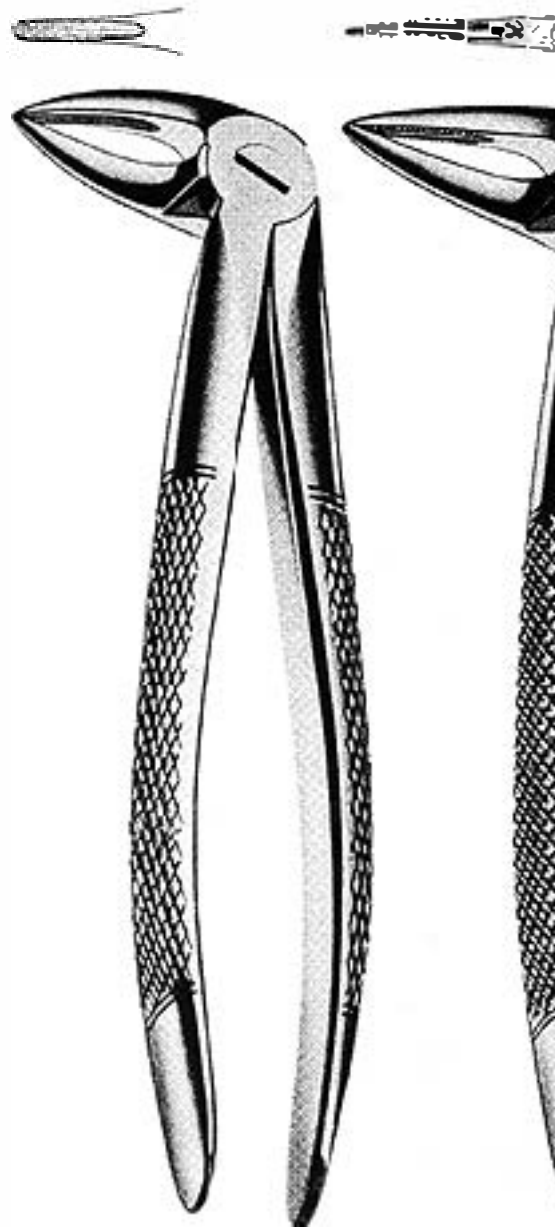

138 1/2  
 04-132-00

33 1/2  
 04-133-00

EXTRACTING FORCEPS, ENGLISH PATTERN  
ZAHNZANGEN, ENGLISCHE FORM  
FORCEPS DE EXTRACCION, FORMA ENGLESA

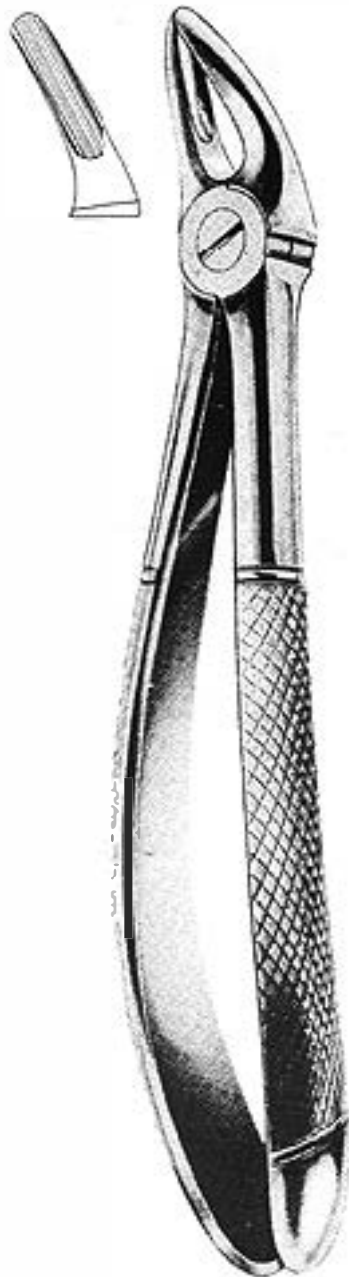

136  
04-136-00

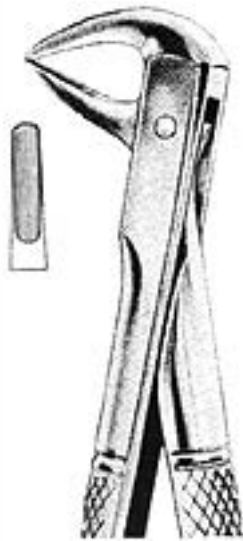

137  
04-135-00



143  
04-138-00

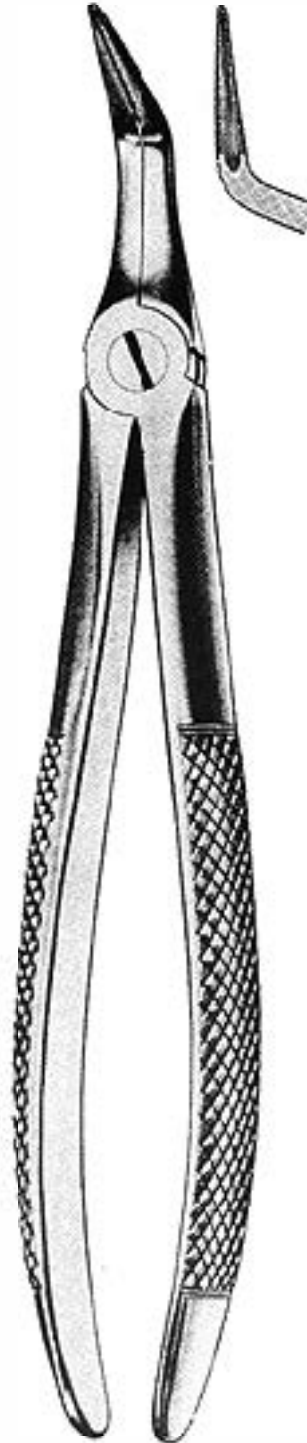

145  
04-137-00

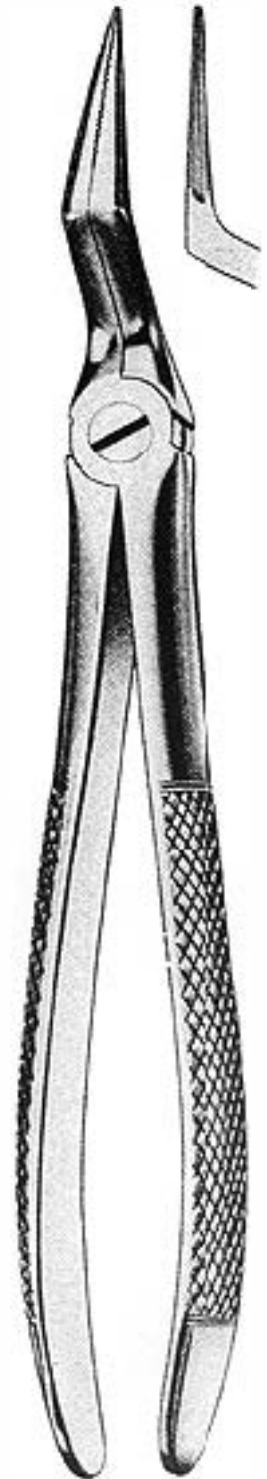

151 1/2  
04-138-00



**STUDENTS SET  
CONSISTING 10 EXTRACTIONS FORCEPS**

4

**STUDENT SET, AVAILABLE  
TEN PIECE IN ONE PACKING**

**● ONE SET CONTAINS:**  
 1 X # 2    1 X # 51  
 1 X # 7    1 X # 67  
 1 X # 13   1 X # 73  
 1 X # 18   1 X # 74  
 1 X # 17   1 X # 79A

04-175-00



2  
04-026-00



7  
04-030-00

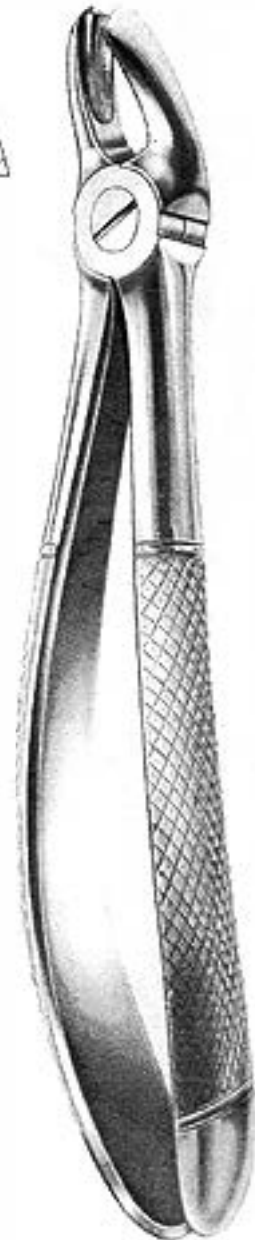

17  
04-033-00



13  
04-034-00



18  
04-038-00



**STUDENTS SET  
CONSISTING 10 EXTRACTIONS FORCEPS**



**ONE SET CONTAINS:**

1 X # 2	04-026-00, 04-027-00	1 X # 51	04-069-00, 04-070-00
1 X # 7	04-030-00, 04-031-00	1 X # 67	04-086-00
1 X # 13	04-034-00, 04-035-00	1 X # 73	04-093-00
1 X # 18	04-038-00, 04-039-00	1 X # 74	04-096-00, 04-097-00
1 X # 17	04-033-00	1 X # 79A	04-105-00

**STUDENT SET, AVAILABLE  
TEN PIECE IN ONE PACKING**

04.175-00



51  
04-069-00

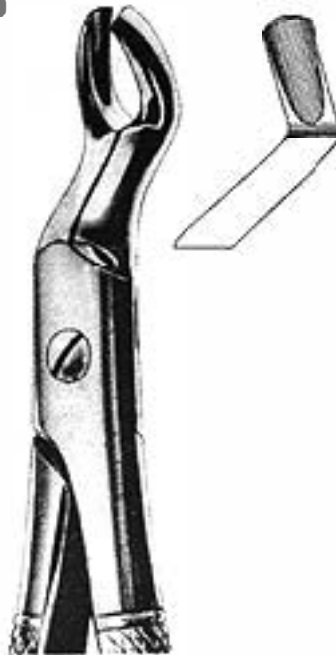

67  
04-086-00



79  
04-105-00

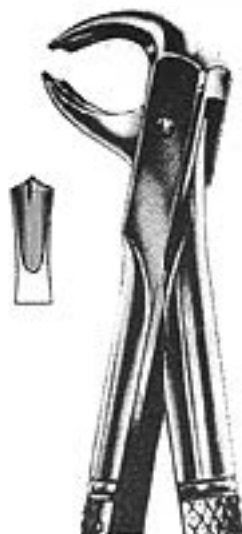

73  
04-093-00

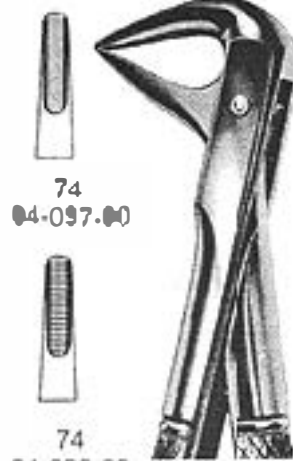

74  
04-096-00

74  
04-097-00



**STUDENTS SET  
EXTRACTING FORCEPS FOR CHILDREN, ENGLISH PATTERN  
FOR CHILDREN PACK OF 5 PIECES**

04

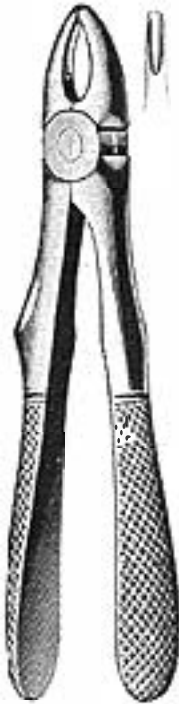

1  
04-275-00

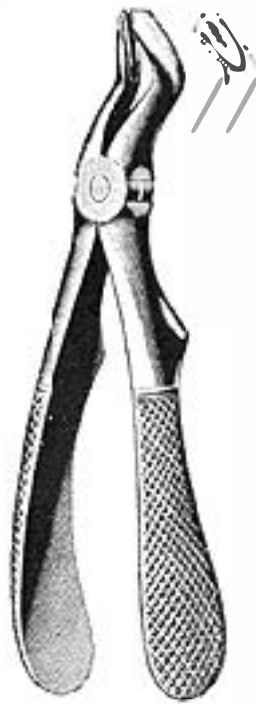

3  
04-276-00

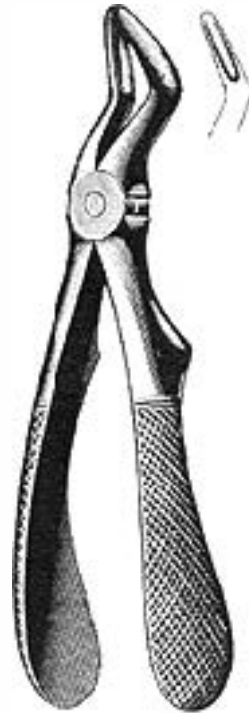

4  
04-280-00

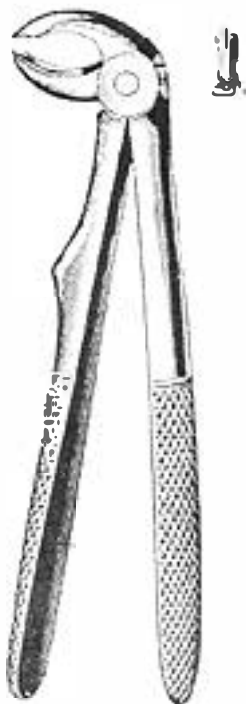

8  
04-281-00

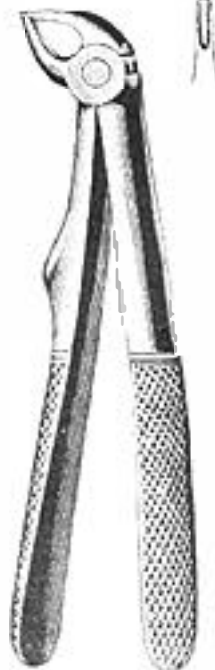

7  
04-278-00

**ONE SET CONTAINS:**  
1 X # 1 04-275-00  
1 X # 3 04-276-00  
1 X # 4 04-280-00  
1 X # 6 04-281-00  
1 X # 7 04-278-00

04-178-00

**WITH SPRING**  
04-177-00

RESECTION FORCEPS  
PINCES A RESECCION  
FORCEPS DE RESECCION

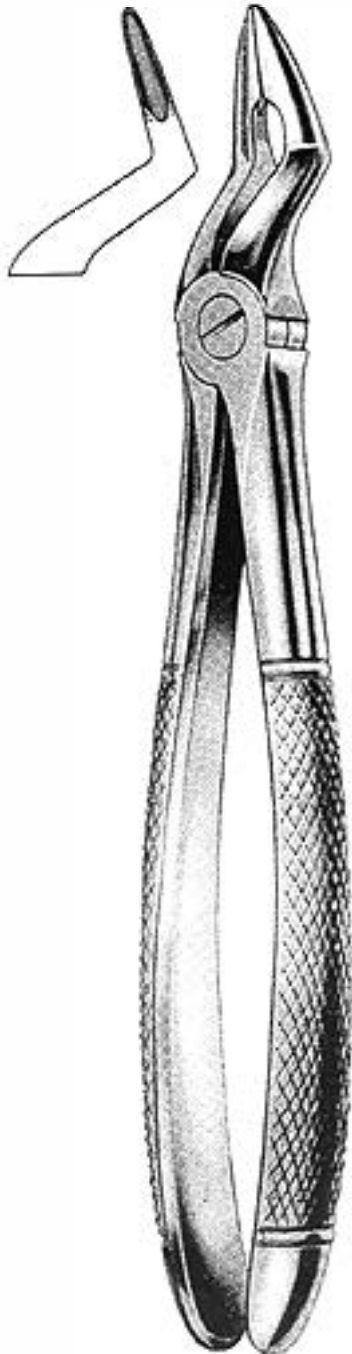
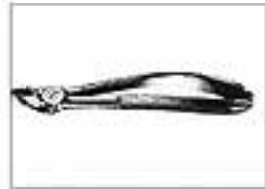

04-161-00  
Witzel



04-162-00

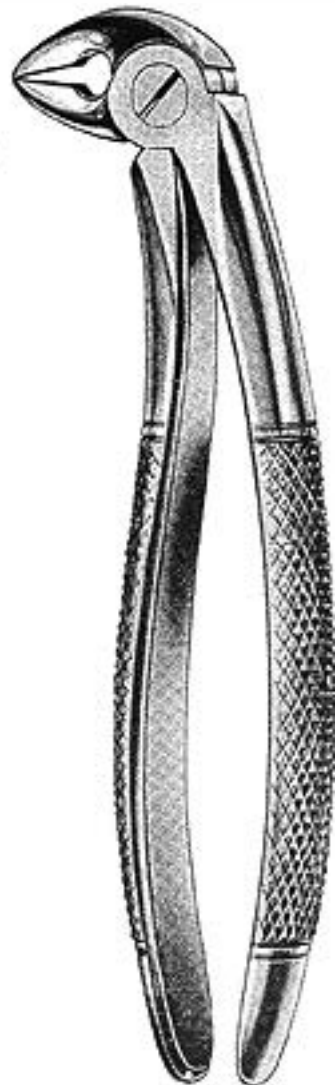

04-163-00

Busch





EXTRACTING FORCEPS  
 DAVIERS  
 FORCEPS DE EXTRACCION

ENGLISH PATTERN  
 FORME ANGLAISE  
 FORMA INGLESA

04



04-164-00



04-165-00

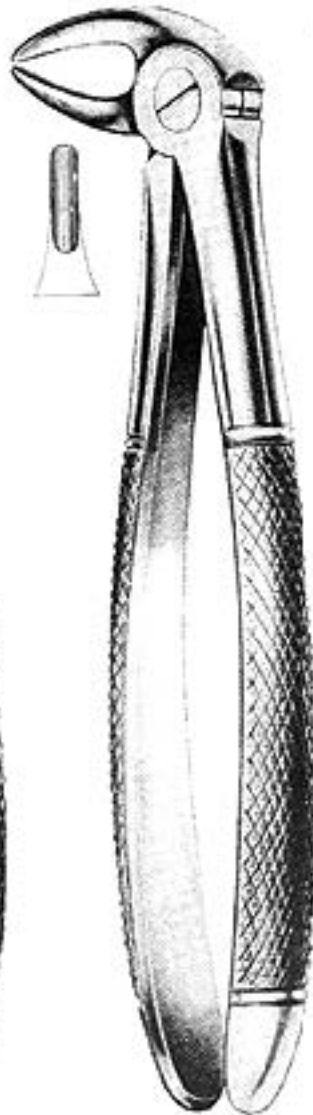

04-166-00

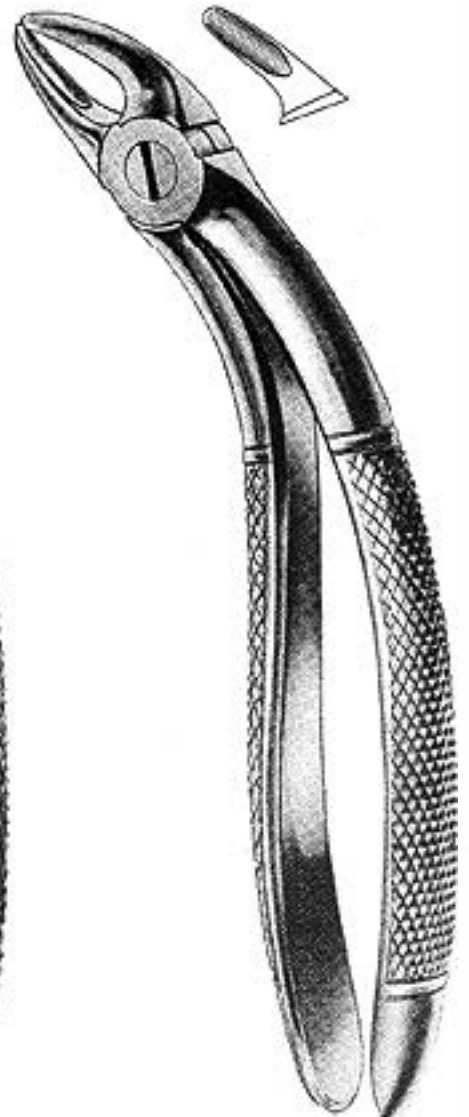

04-167-00

Stiksa

Hertz

WISDOM EXTRACTING FORCEPS  
DAVIERS POUR DENTS DE SAGESSE  
FORCEPS PARA CORDALES

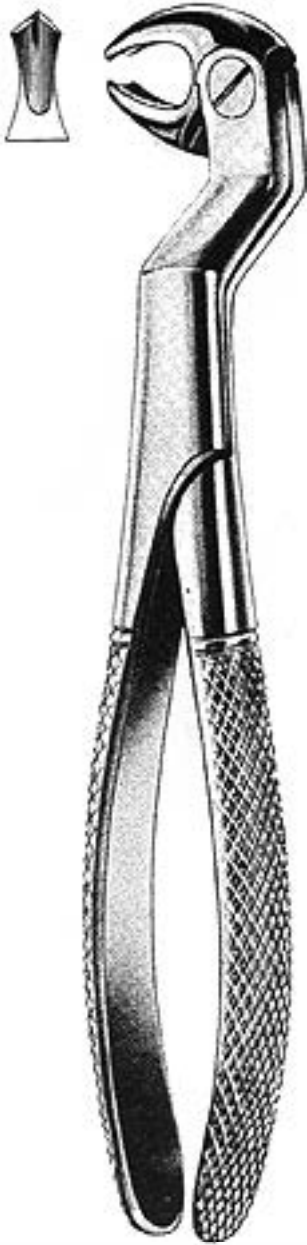

22 1/2 L  
04-168-00



33 1/2 L  
04-159-00



33 1/2 R  
04-170-00



22 1/2 R  
04-171-00

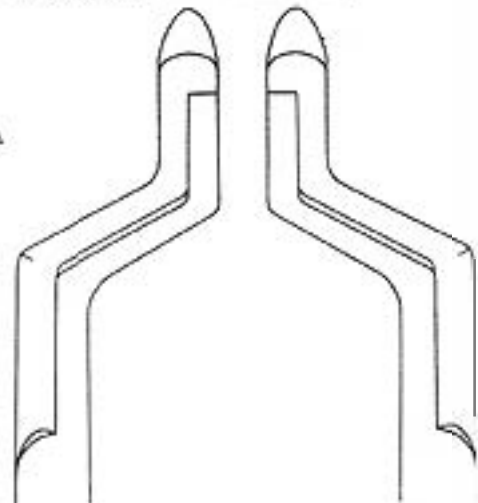

Routurier

Routurier



ROOT SPLINTER FORCEPS  
 PINCES A FRAGMENTOS  
 PINZAS PARA FRAGMENTOS

04

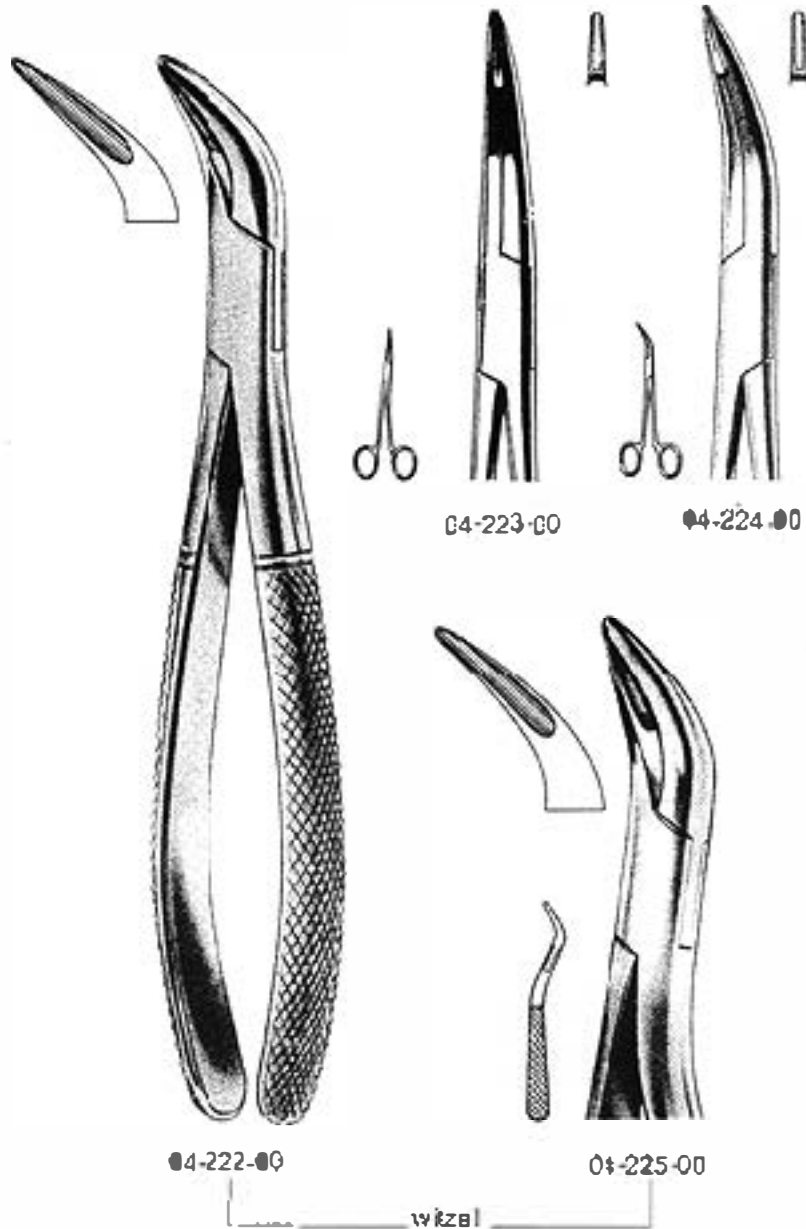

EXTRACTING FORCEPS, FOR CHILDREN, ENGLISH PATTERN  
ZAHNZANGE FÜR KINDER MIT ENGLISCHE FORM  
FORCEPS DE EXTRACCION PARA CON, FORMA ENGLISH



1  
04 275-00



3  
04 276-00



5  
04 277-00



7  
04 278-00



2  
04 279-00



4  
04 280-00



6  
04 281-00



EXTRACTING FORCEPS. FOR CHILDREN, ENGLISH PATTERN  
 ZAHNZANGE FÜR KINDER MIT FEDER, ENGLISCHE FORM  
 FORCEPS DE EXTRACCION PARA CONE REAORTE, FORMA  
 ENGLISH

04



137  
04-282-00



139  
04-283-00

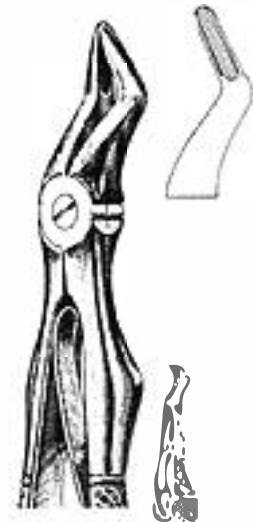

51  
04-284-00

Klein

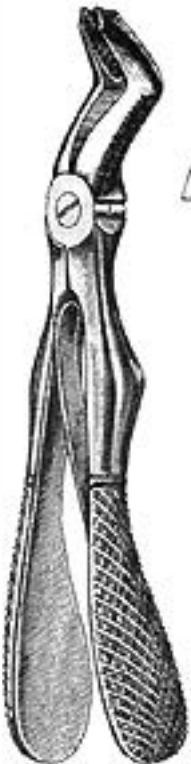

3  
04-285-00

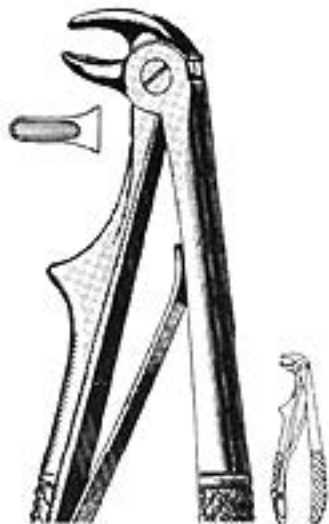

5  
04-286-00



6  
04-287-00

Klein

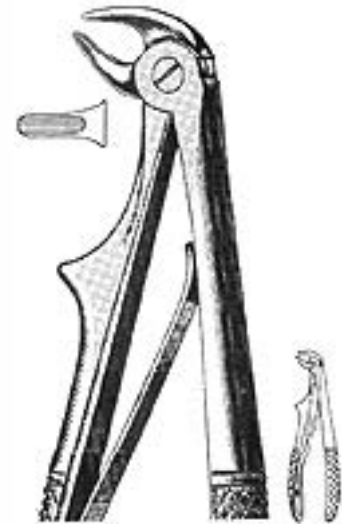

7  
04-288-00

EXTRACTING FORCEPS, ENGLISH PATTERN  
ZAHNZANGE ENGLISCHE FORM  
FORCEPS DE EXTRACCION FORMA ENGLESA



13 K  
04-289-00



33 K  
04-290-00



40  
04-291-00



22 K  
04-292-00



38  
04-293-00



73 K  
04-294-00



EXTRACTING FORCEPS, ENGLISH PATTERN  
 ZAHNZANGE ENGLISCHE FORM  
 FORCEPS DE EXTRACCION FORMA ENGLESA



17 K  
 04-295-00



18 K  
 04-296-00



18 K  
 04-297-00



37  
 04-301-00



29 K  
 04-298-00



51 K  
 04-299-00



39 K  
 04-300-00

EXTRACTING FORCEPS, ENGLISH PATTERN  
ZAHNZANGE ENGLISCHE FORM  
FORCEPS DE EXTRACCION FORMA ENGLISA

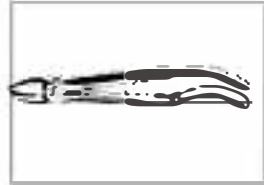

**WITH DIAMOND  
DUST COATING**

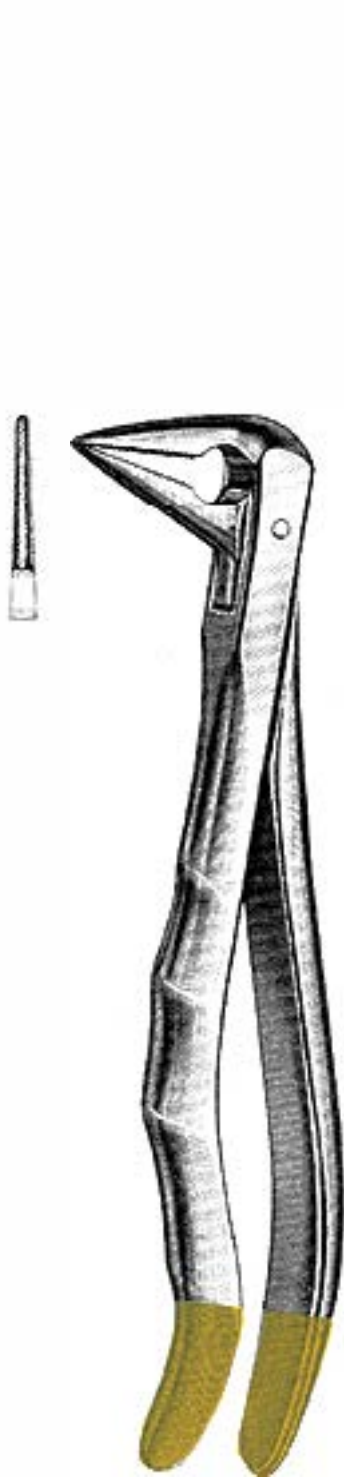

59  
04-351-00

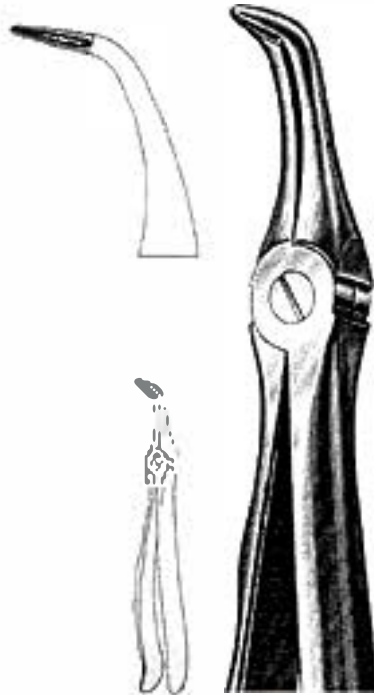

46  
04-352-00

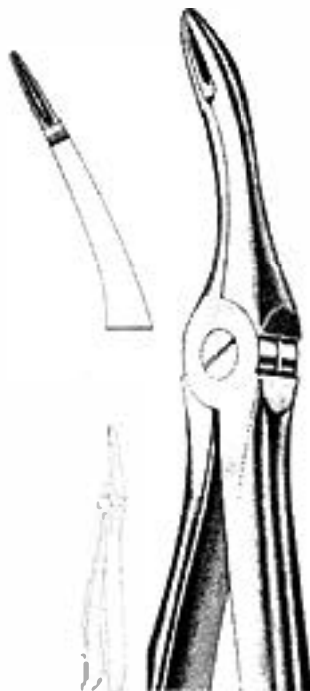

49  
04-353-00

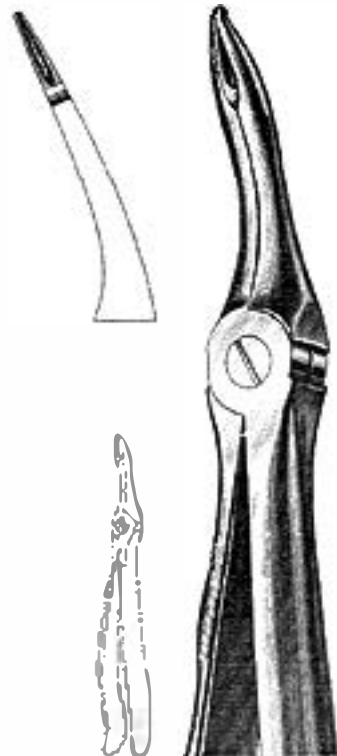

44  
04-354-00



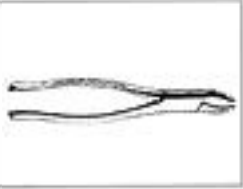

EXTRACTING FORCEPS, AMERICAN PATTERN  
 ZAHNZANGE AMERICAN FORM  
 FORCEPS DE EXTRACCION FORMA AMERICANA

04



1  
 04-405-00  
 Standard

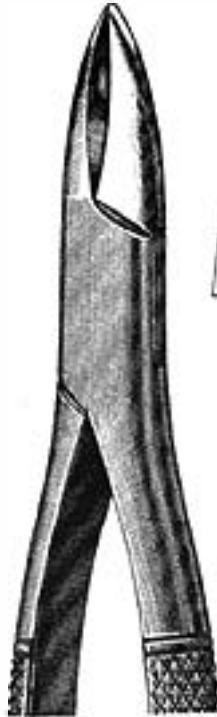

1 A  
 04-406-00  
 Hengahan

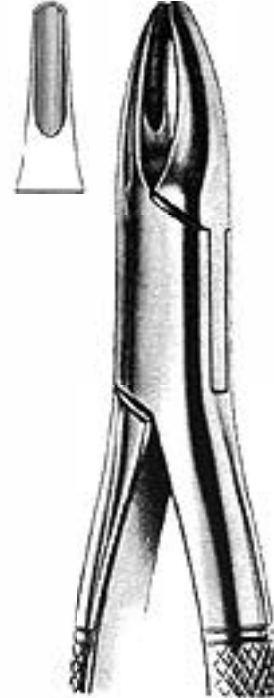

1 B  
 04-407-00  
 Normal



2  
 04-408-00

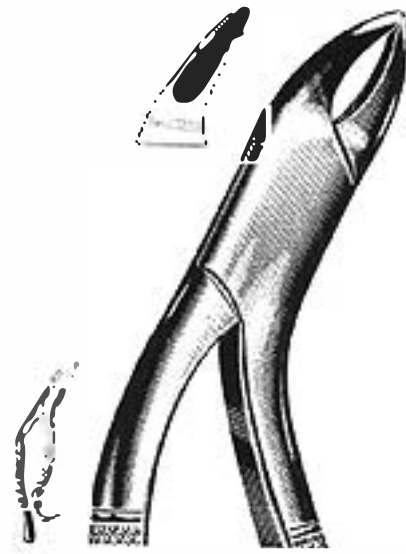

3  
 04-409-00

EXTRACTING FORCEPS, AMERICAN PATTERN  
ZAHNZANGE AMERICAN FORM  
FORCEPS DE EXTRACCION FORMA AMERICANA

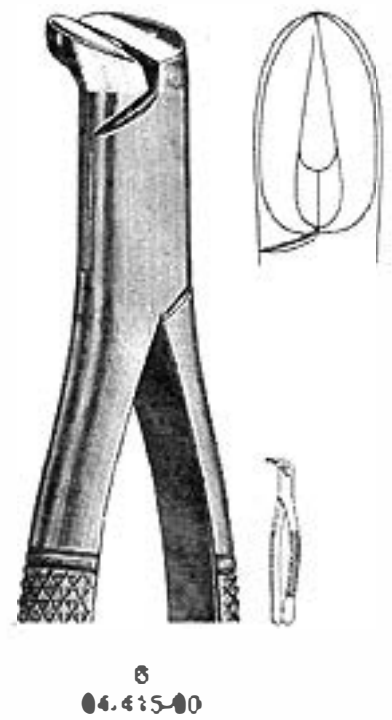
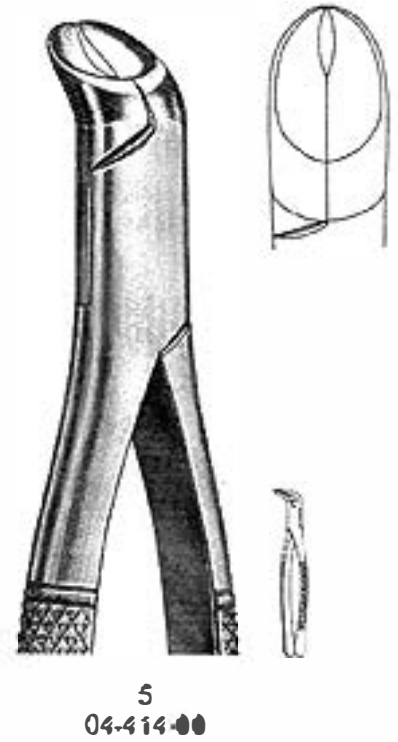
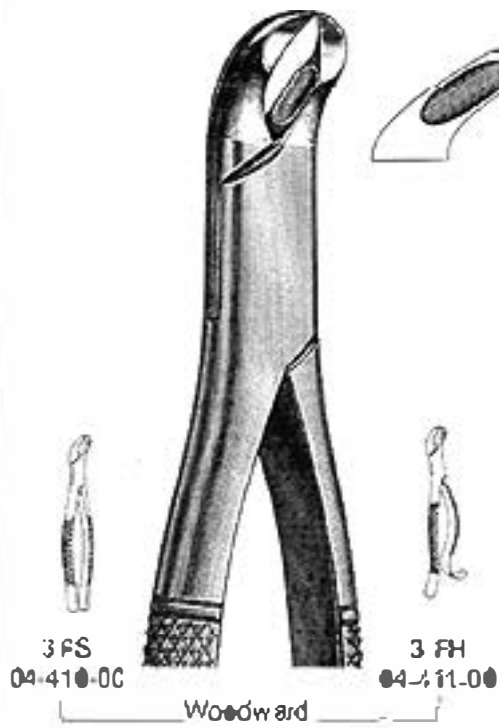
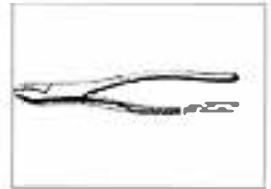

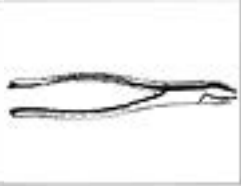

EXTRACTING FORCEPS, AMERICAN PATTERN  
 ZAHNZANGEN AMERICAN FORM  
 FORCEPS DE EXTRACCION FORMA AMERICANA



10 H  
 04-418-00



13  
 04-417-00



14  
 04-418-00

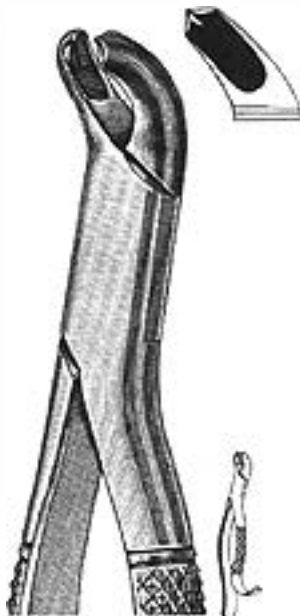

15  
 04-419-00  
 Harris

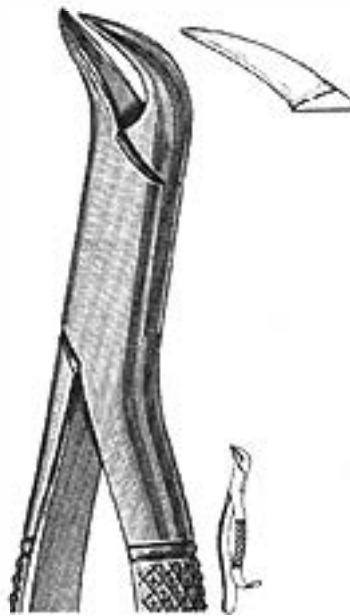

16  
 04-420-00

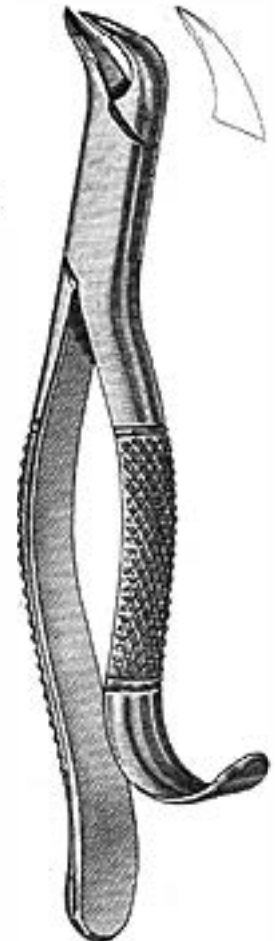

16 S  
 04-421-00

EXTRACTING FORCEPS, AMERICAN PATTERN  
ZAHNZANGE AMERICAN FORM  
FORCEPS DE EXTRACCION FORMA AMERICANA

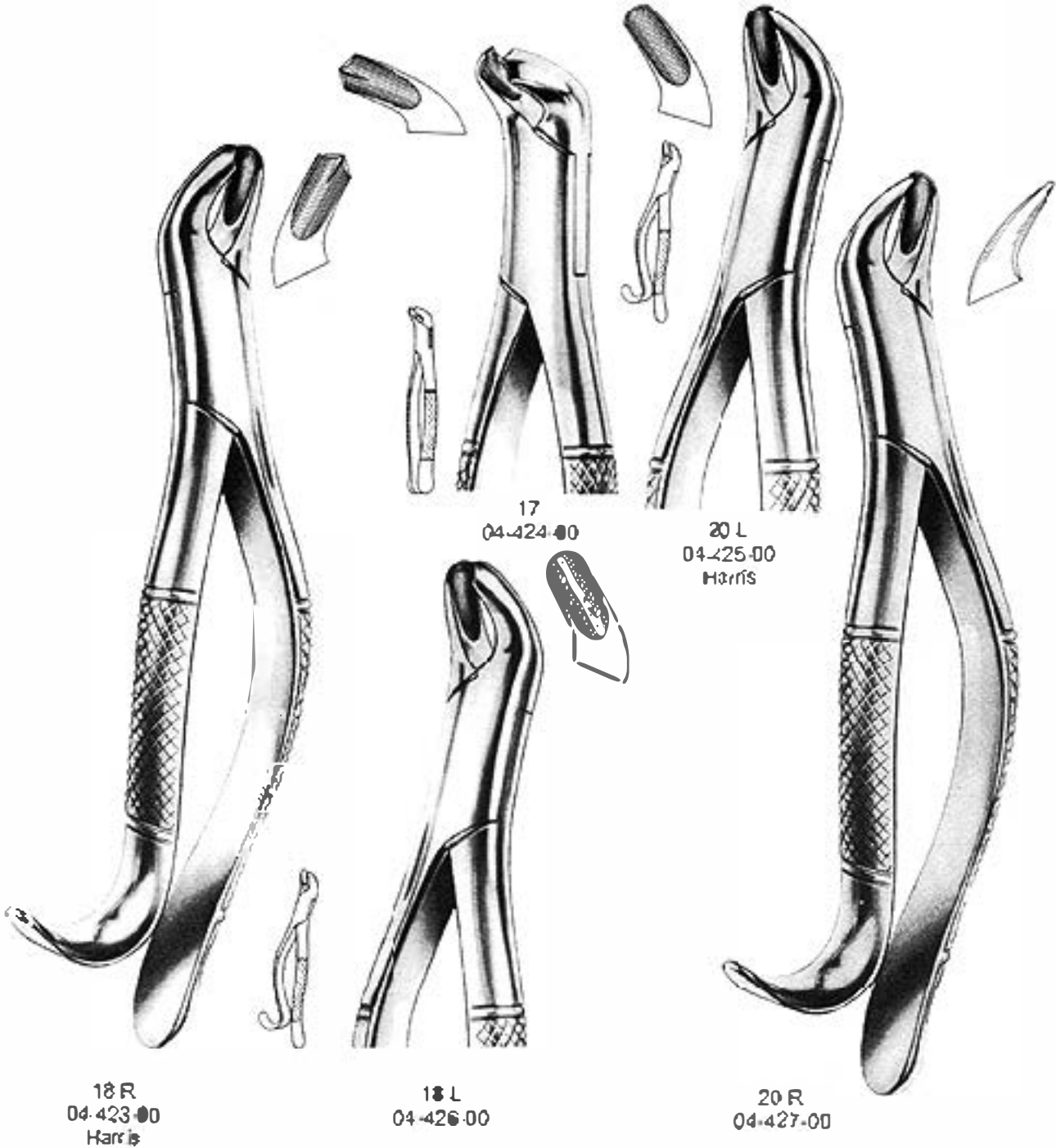
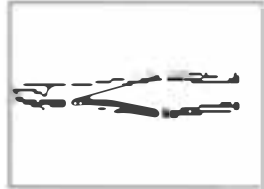

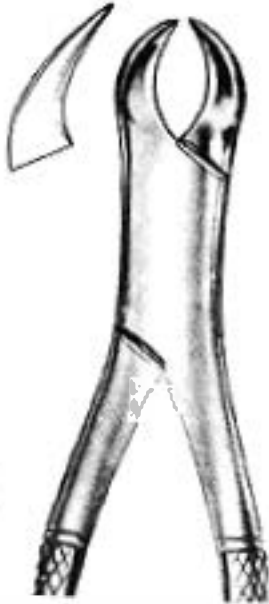

23  
 04-428-00

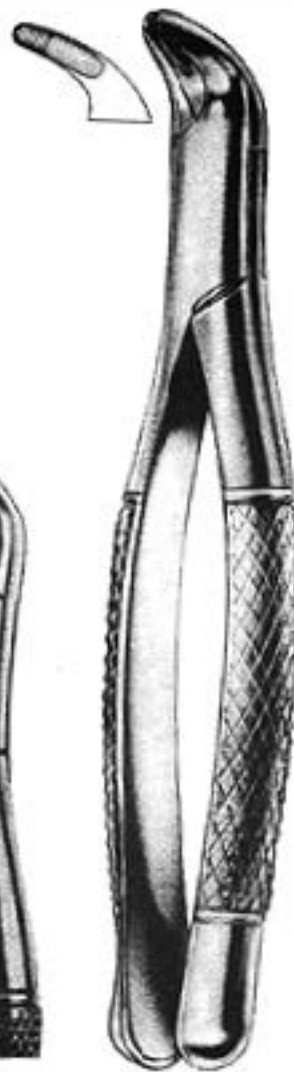

29 S  
 04-431-00



30 S  
 04-432-00



24  
 04-429-00

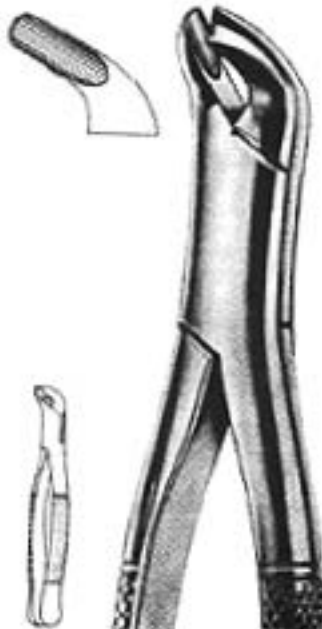

27  
 04-430-00

EXTRACTING FORCEPS, AMERICAN PATTERN  
ZAHNZANGE AMERICAN FORM  
FORCEPS DE EXTRACCION FORMA AMERICANA

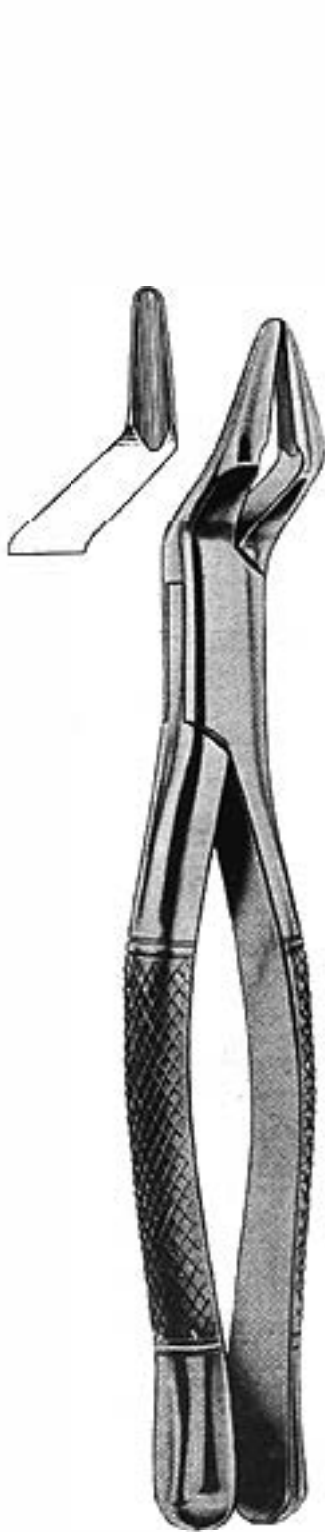
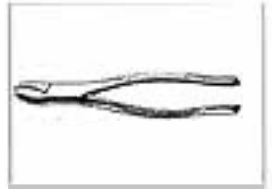

32  
04-433-00  
Pamly

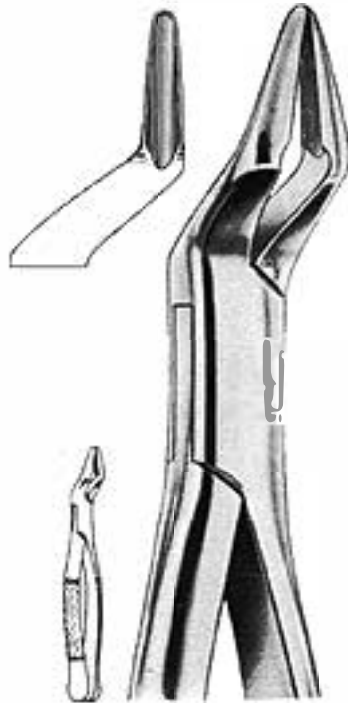

32 A  
04-434-00

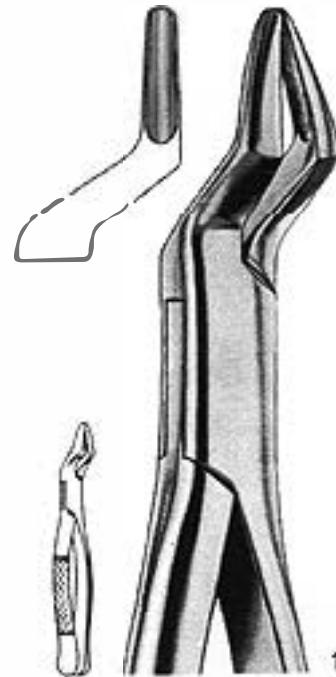

35  
04-438-00

1/1

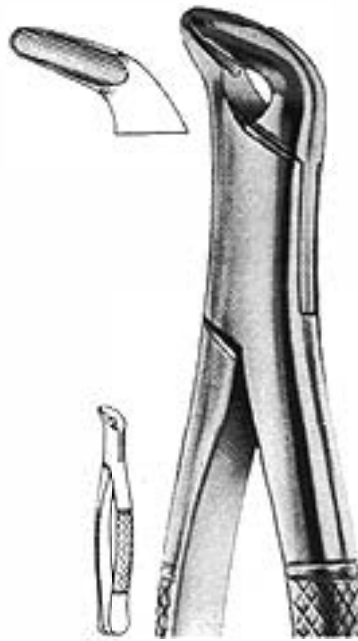

34  
04-435-00



EXTRACTING FORCEPS, AMERICAN PATTERN  
 ZAHNZANGE AMERICAN FORM  
 FORCEPS DE EXTRACCION FORMA AMERICANA

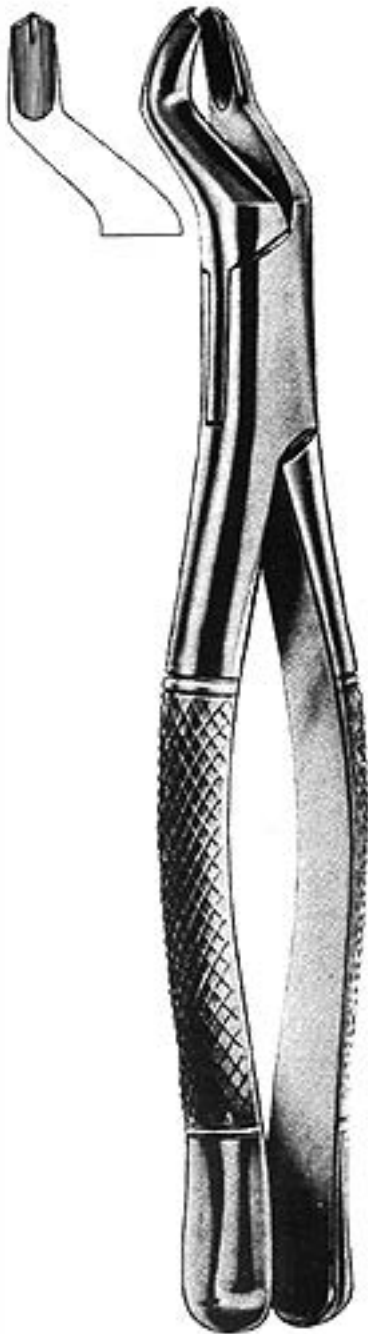

53 R  
 04-437-00



36  
 04-438-00

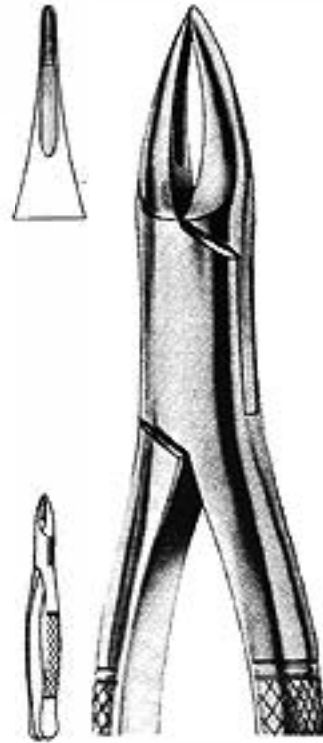

38  
 04-439-00

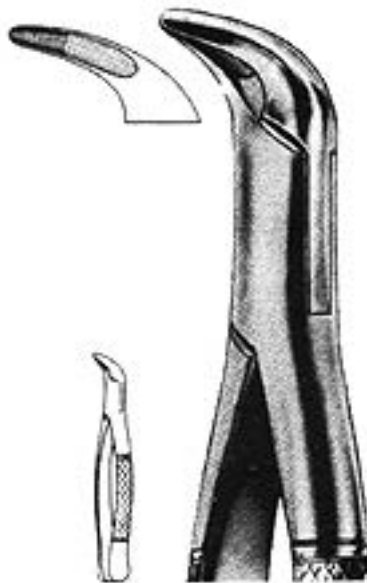

37  
 04-440-00

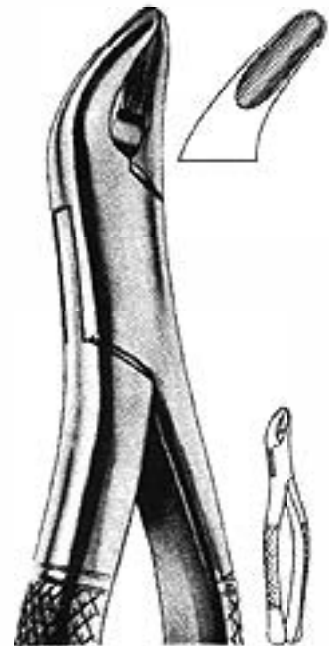

62  
 04-441-00

EXTRACTING FORCEPS, AMERICAN PATTERN  
ZAHNZANGE AMERICAN FORM  
FORCEPS DE EXTRACCION FORMA AMERICANA

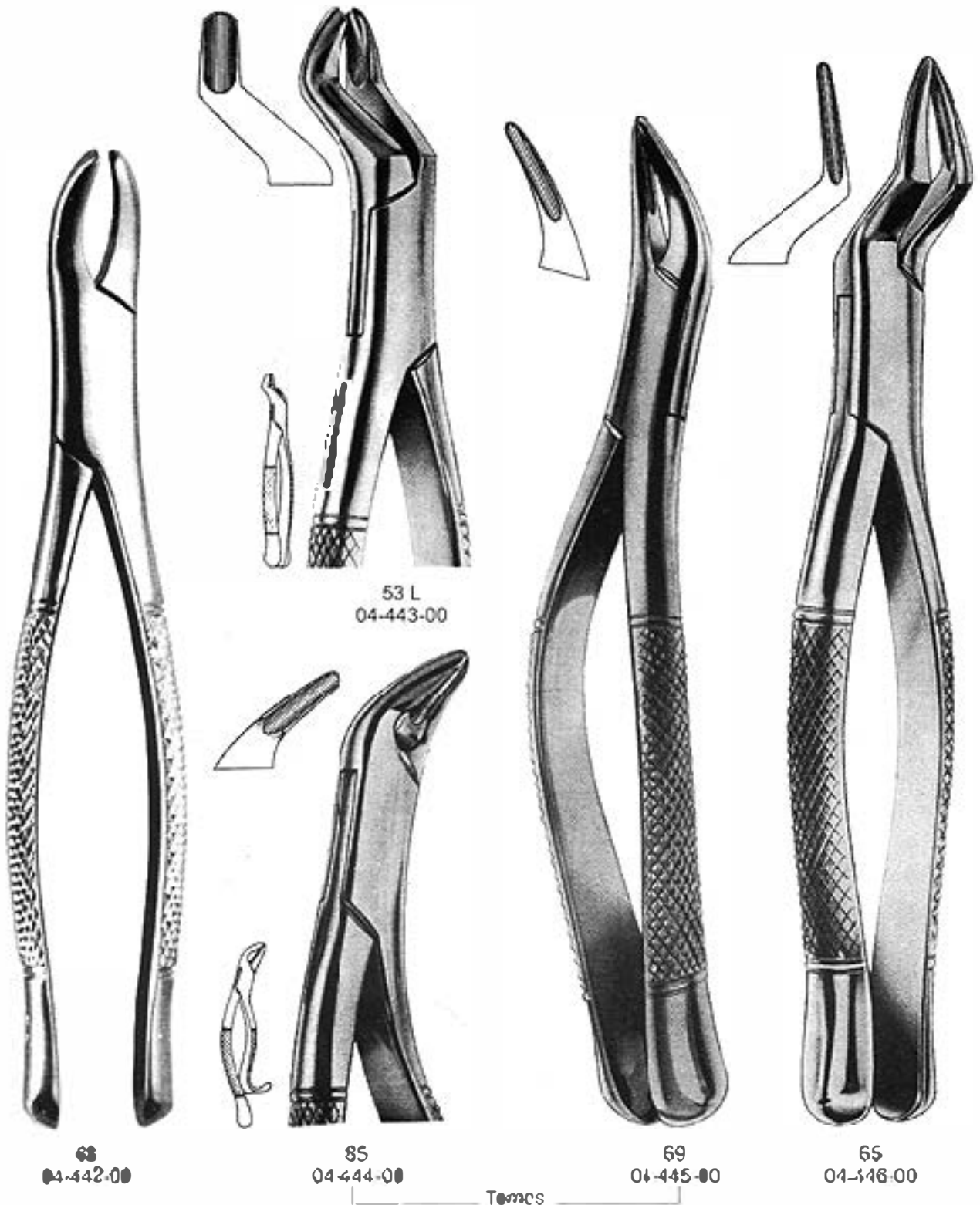
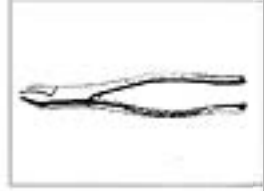



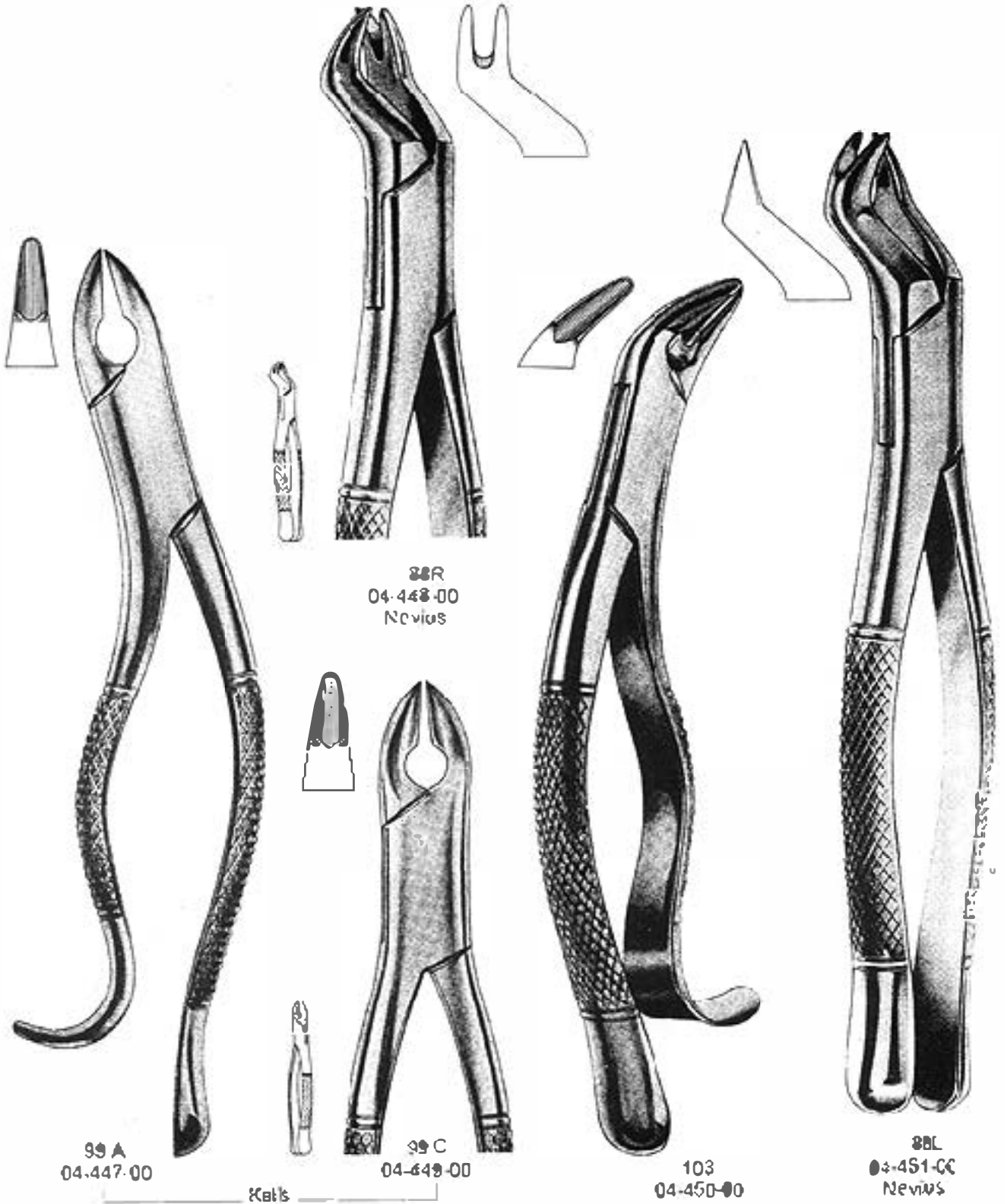
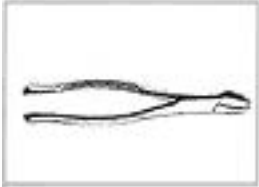

EXTRACTING FORCEPS, AMERICAN PATTERN  
ZAHNZANGE AMERICAN FORM  
FORCEPS DE EXTRACCION FORMA AMERICANA

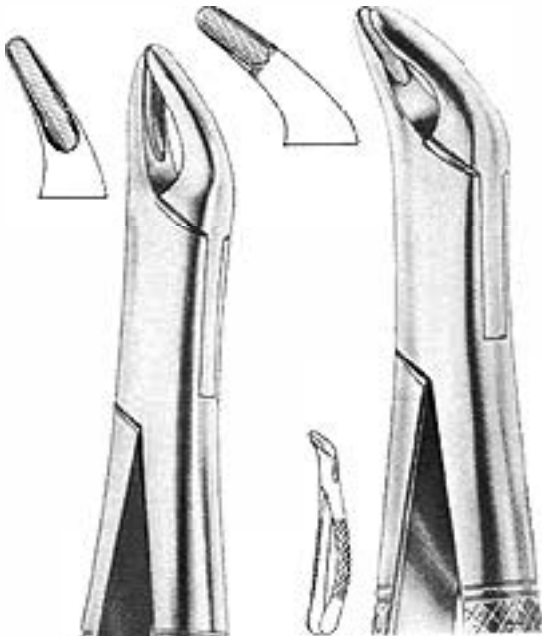

150 A  
04-453-00

150 S  
04-452-00

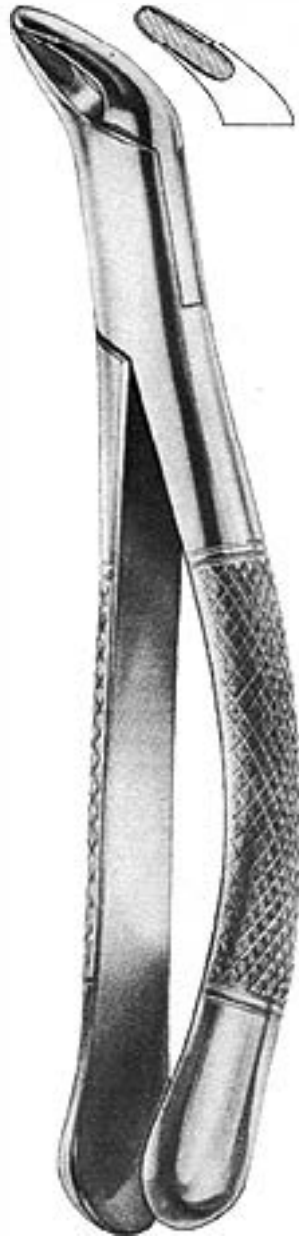

151  
04-455-00

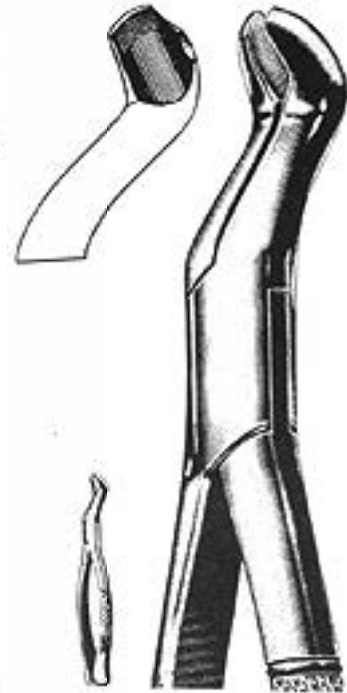

121  
04-456-00

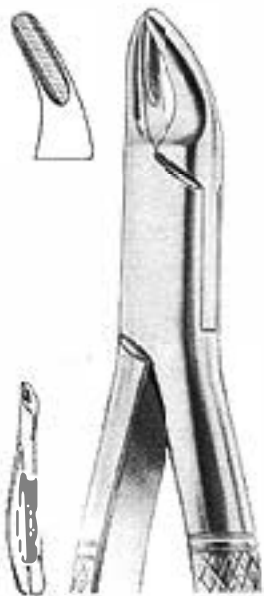

150  
04-454-00

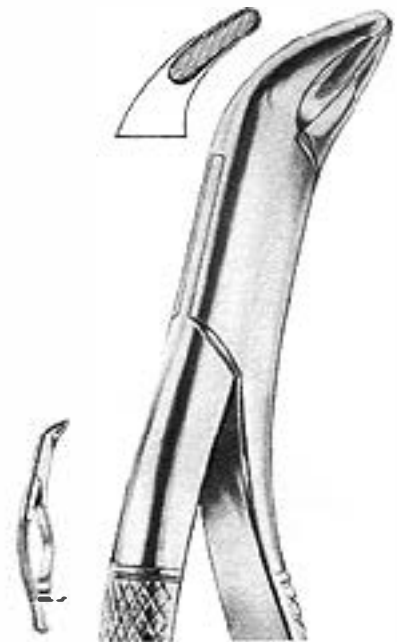

108  
04-457-00

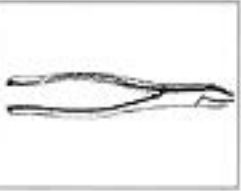

EXTRACTING FORCEPS, AMERICAN PATTERN  
 ZAHNZANGEN AMERICAN FORM  
 FORCEPS DE EXTRACCION FORMA AMERICANA



203

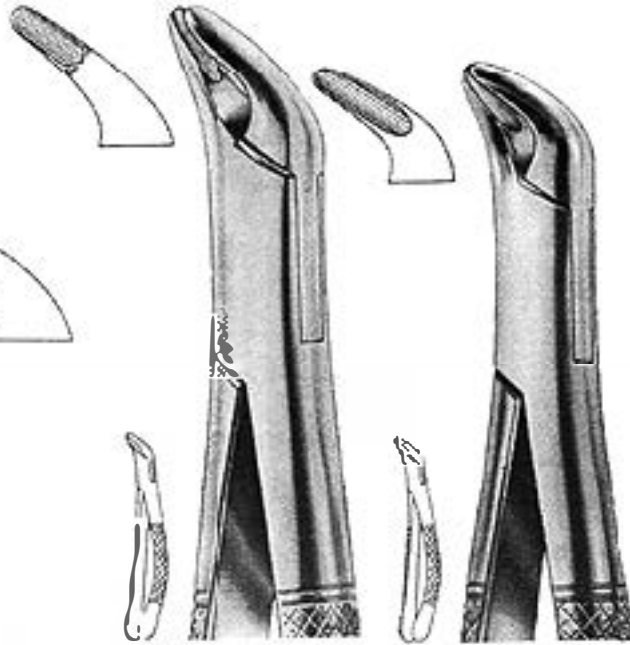

151A  
04.459-00

151 S  
04-460-00



201  
04-461-00

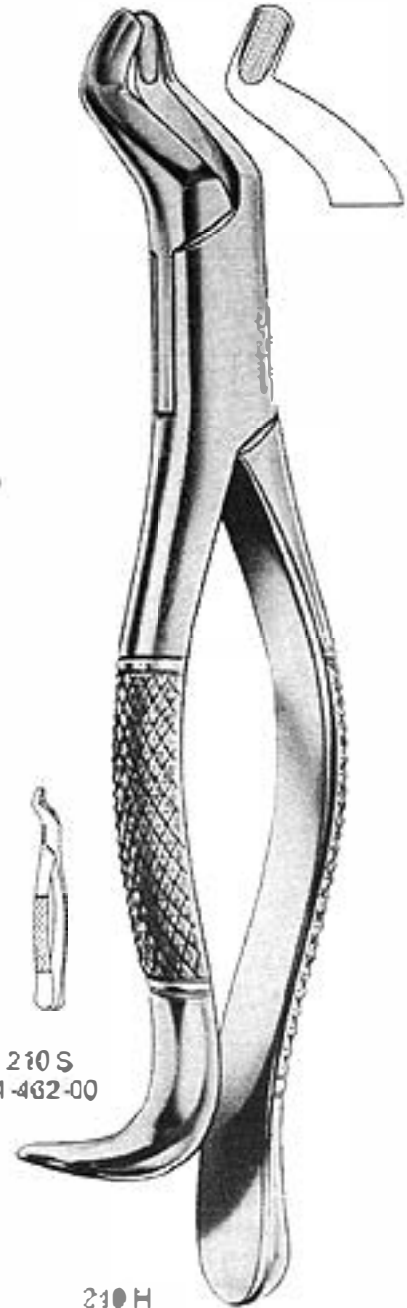

210 S  
04-462-00

210 H  
04.463-00

EXTRACTING FORCEPS. AMERICAN PATTERN  
ZAHNZANGE AMERICAN FORM  
FORCEPS DE EXTRACCION FORMA AMERICANA

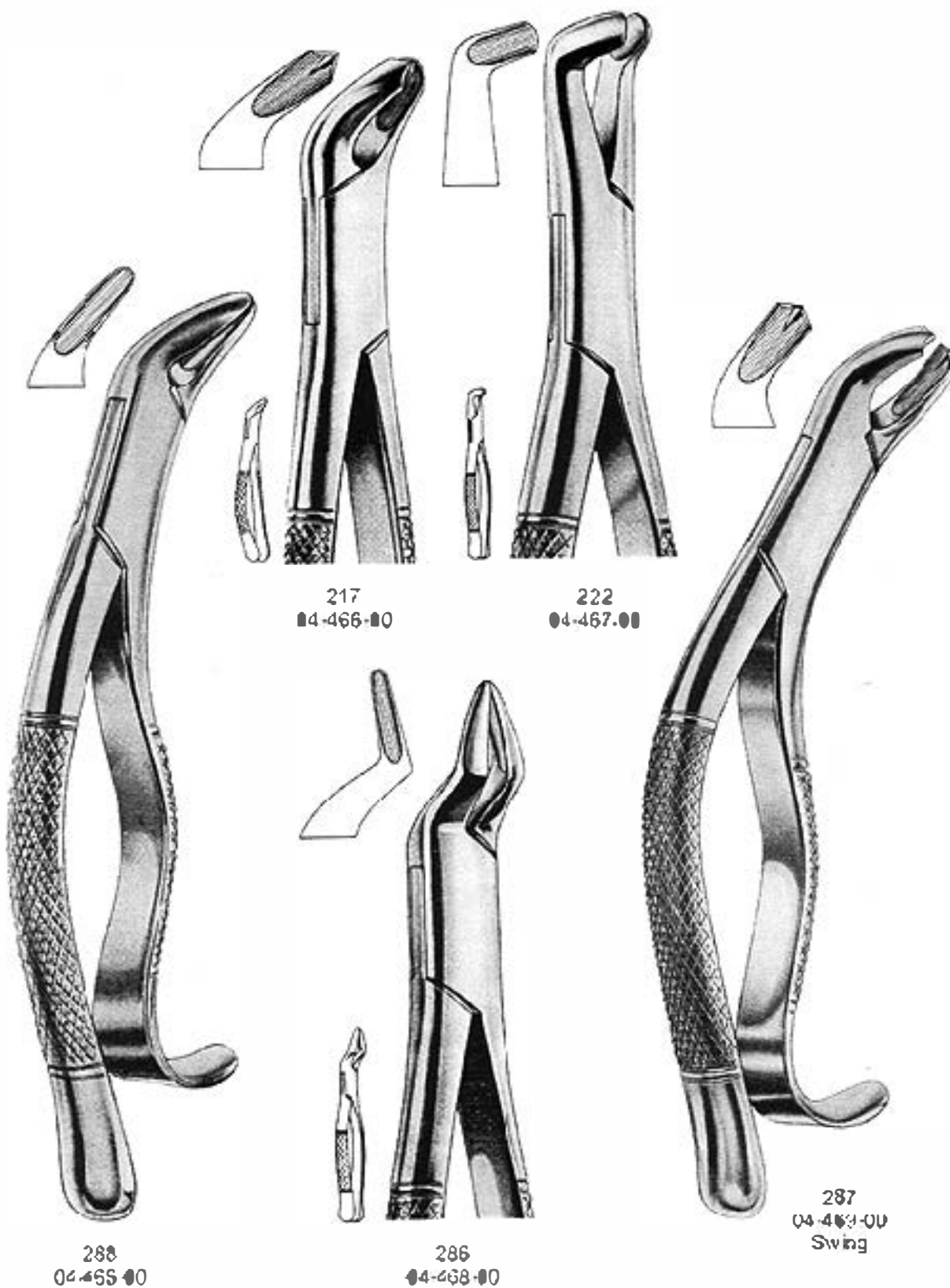
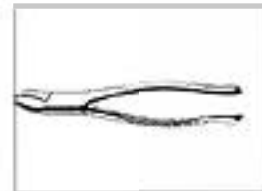



**EXTRACTING FORCEPS, AMERICAN PATTERN**  
**ZAHNZANGEN AMERICAN FORM**  
**FORCEPS DE EXTRACCION FORMA AMERICANA**

C4

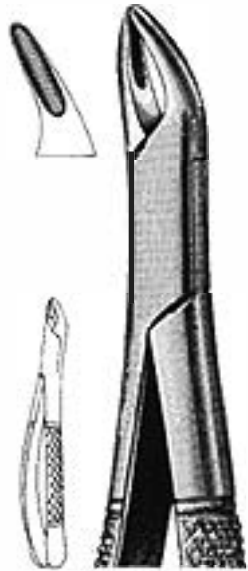

**150 S**  
**04-470-00**

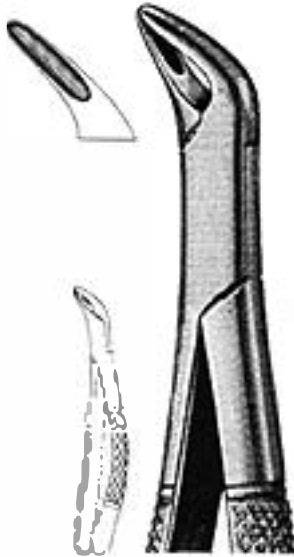

**151 S**  
**04-471-00**

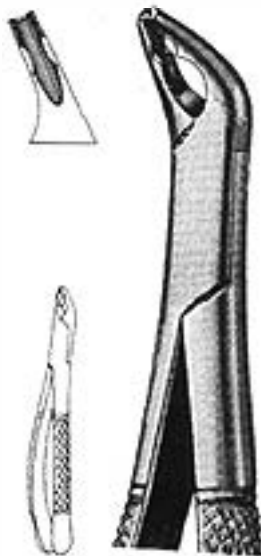

**151 XAS**  
**04-473-00**

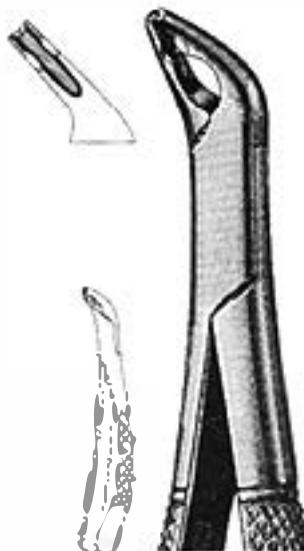

**151 XAS**  
**04-473-00**

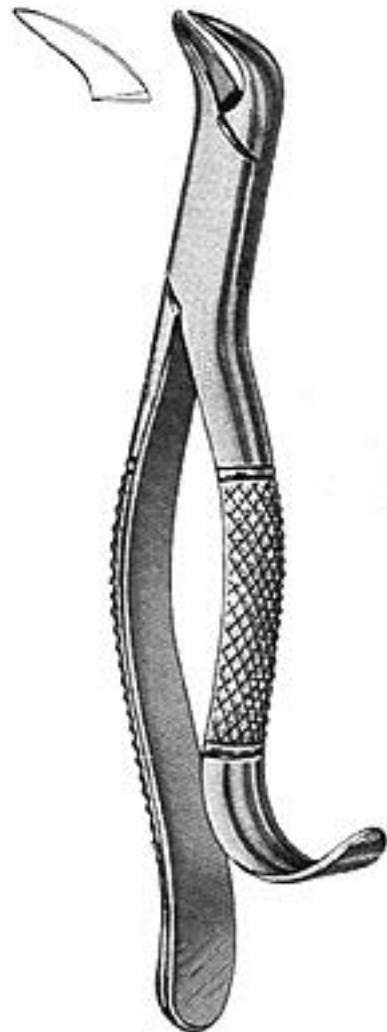

**16 S**  
**04-474-00**

EXTRACTING FORCEPS, AMERICAN PATTERN  
ZAHNZANGE AMERICAN FORM  
FORCEPS DE EXTRACCION FORMA AMERICANA



17 SK  
04-475-00



23 SK  
04-477-00

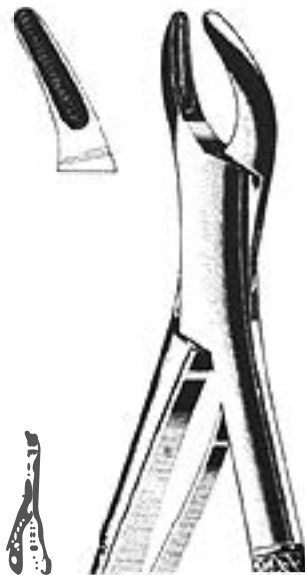

150 SK  
04-476-00

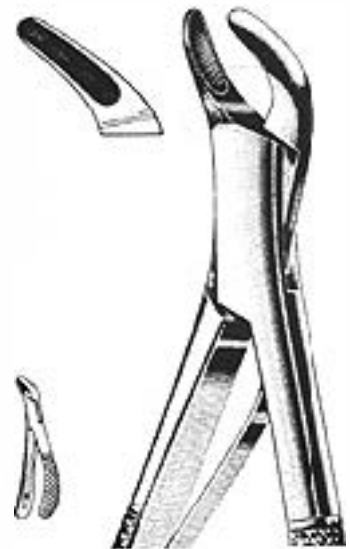

151 SK  
04-478-00

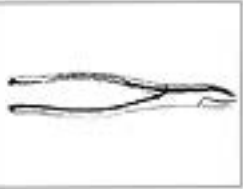

ROOT FRAGMENT FORCEPS  
 WURZELSPITTERZANGEN  
 FORCEPS PARA FRAGMENTOS DE RAICES

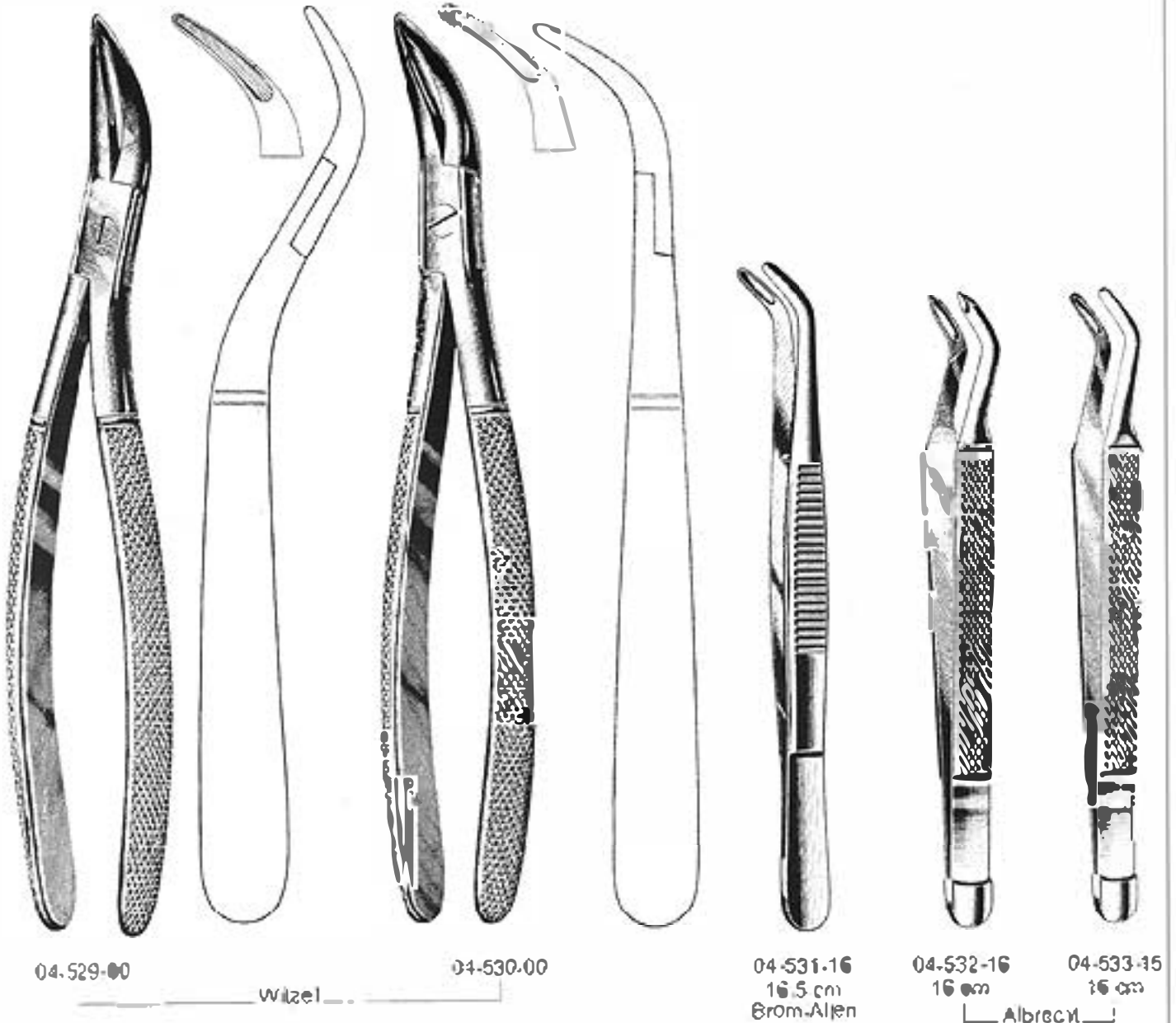

04-529-00

Witzel

04-530-00

04-531-16  
 16.5 cm  
 Brom-Allen

04-532-16  
 16 cm

Albrecht

04-533-15  
 16 cm

EXTRACTING FORCEPS, AMERICAN PATTERN  
ZAHNZANGEN AMERICAN FORM  
FORCEPS DE EXTRACCION FORMA AMERICANA



**WITH DIAMOND  
DUST COATING**



1  
04-584-00



99  
04-585-00



04-586-00





EXTRACTING FORCEPS AMERICAN PATTERN  
 ZAHNZANGEN AMERICAN FORM  
 FORCEPS DE EXTRACCIÓN FORMA AMERICANA

04

**WITH DIAMOND  
 DUST COATING**

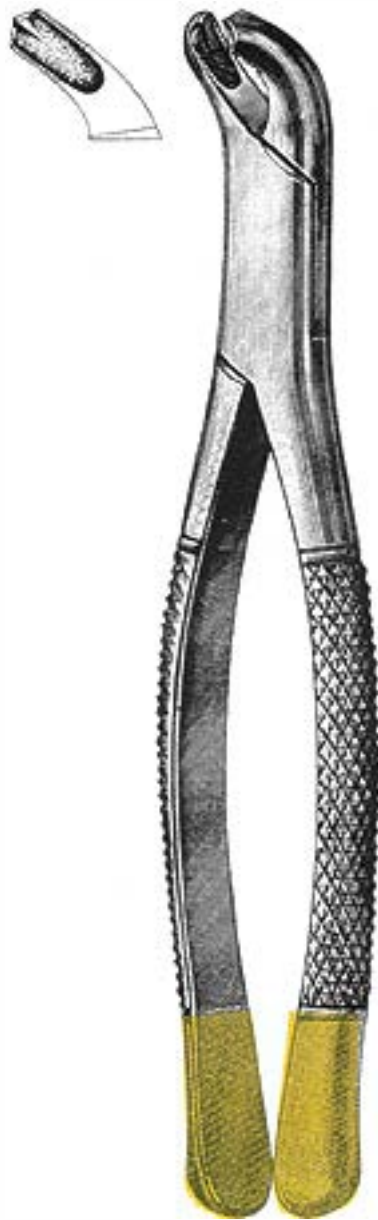

17  
 04-587-00

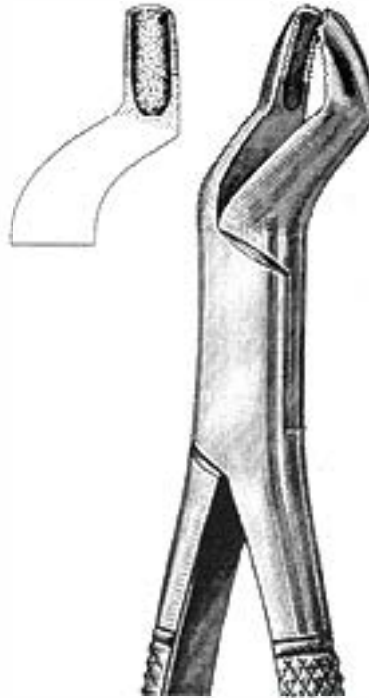

53 L  
 04-588-00

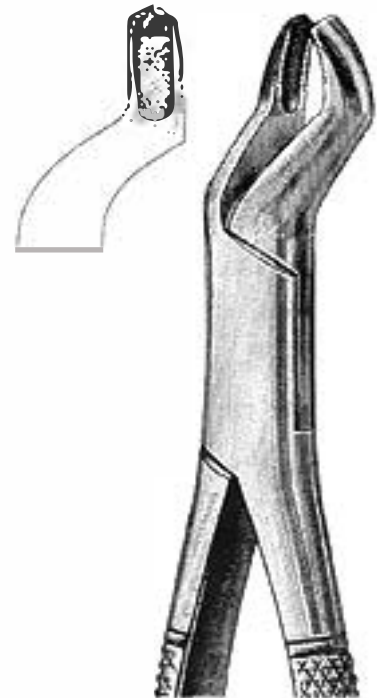

53 R  
 04-589-00



65  
 04-590-00

EXTRACTING FORCEPS, AMERICAN PATTERN  
 ZAHNZANGE AMERICAN FORM  
 FORCEPS DE EXTRACCIÓN FORMA AMERICANA

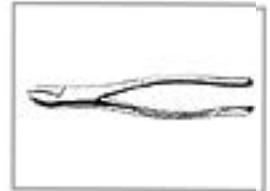

**WITH DIAMOND  
 DUST COATING**

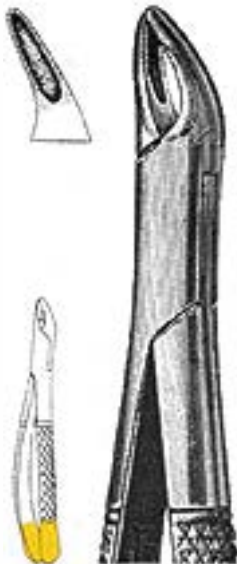

150 S  
 04-591-00

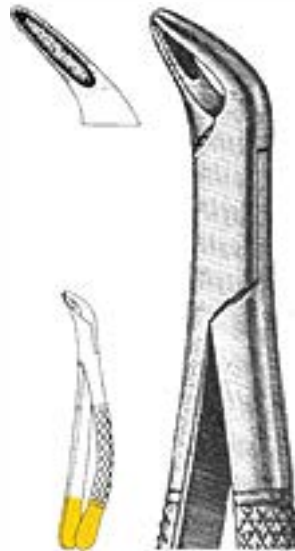

151 S  
 04-592-00

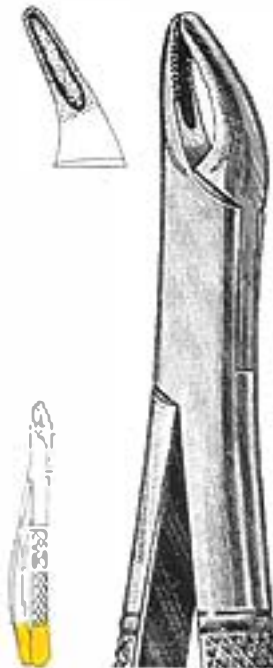

150  
 04-593-00

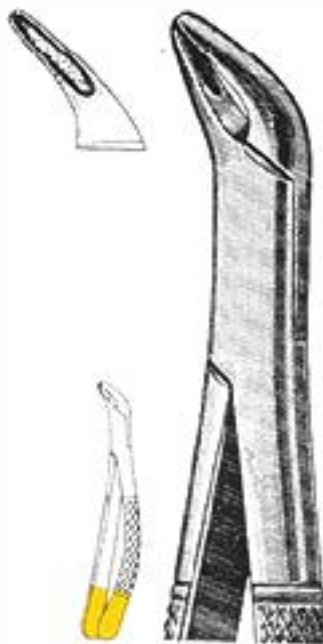

151  
 04-594-00

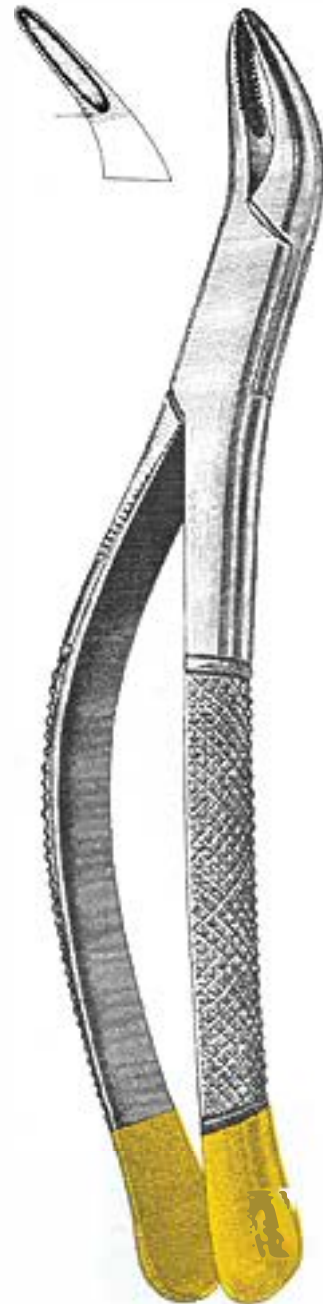

68  
 04-595-00

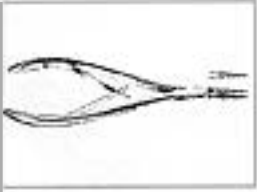

**SPLINTER FORCEPS**  
**PINCES A FRAGMENTOS**  
**PINZAS PARA FRAGMENTOS**



Department

05

PERIODONTAL INSTRUMENTS  
INSTRUMENTE FÜR DIE PARODONTOLOGIE  
INSTRUMENTSOS PARA PERODONCIA

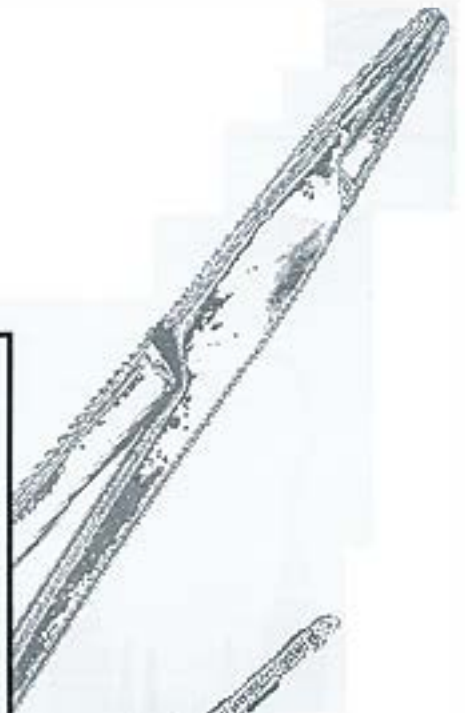
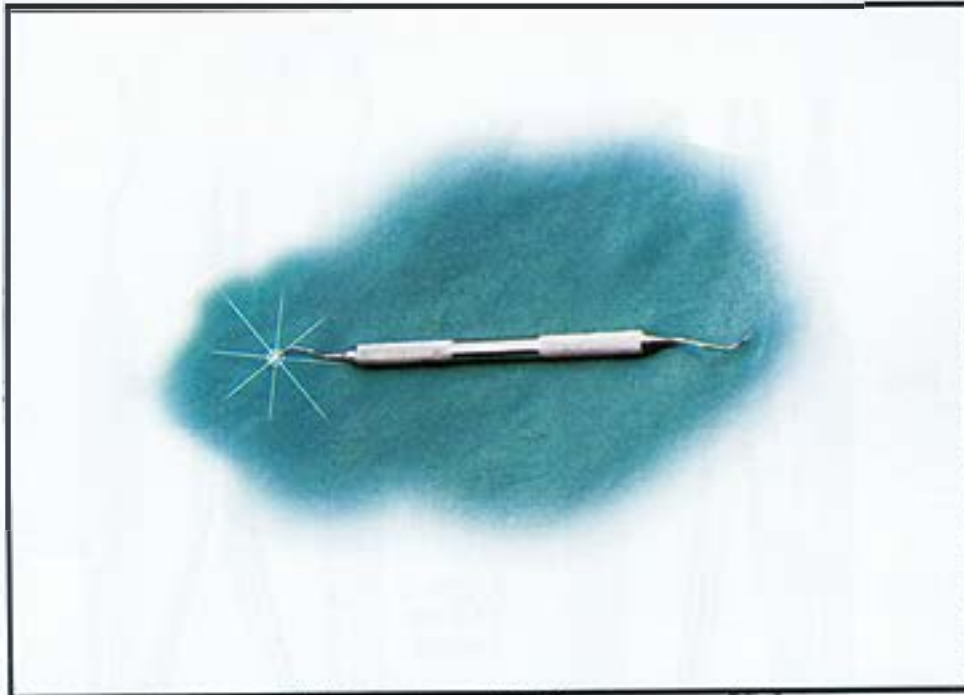

DEPARTMENT NO. 5

FROM  
PAGE#

106

TO  
PAGE#

114

INSTRUMENTS CATEGORY

PERIODONTAL INSTRUMENTS  
INSTRUMENTE FÜR DIE PARODONTOLOGIE  
INSTRUMENTOS PARA PERIODONCIA



AA

AA  
CTA-Classic  
Solid handle Ø5.5 mm



BB

BB  
SLIM-Action  
Solid handle Ø6 mm



CC

CC  
COBRA-Series  
Hollow handle Ø8 mm



DD

DD  
RING-O-Lite  
Hollow handle Ø8 mm



EE

EE  
FEATHER Feel  
Hollow handle Ø8 mm



FF

FF  
SOFTHOLD  
Hollow handle Ø8 mm



GG

GG  
MAX GRIP  
(For detail: Please read catalogue page no. 133)

**NOTE: Any one of the above handles can be choosed for hand instruments just by given reference of any required HANDLE.**

PERIODONTAL INSTRUMENTS  
INSTRUMENTE FÜR DIE PARODONTOLOGIE  
INSTRUMENTSOS PARA PERODONCIA

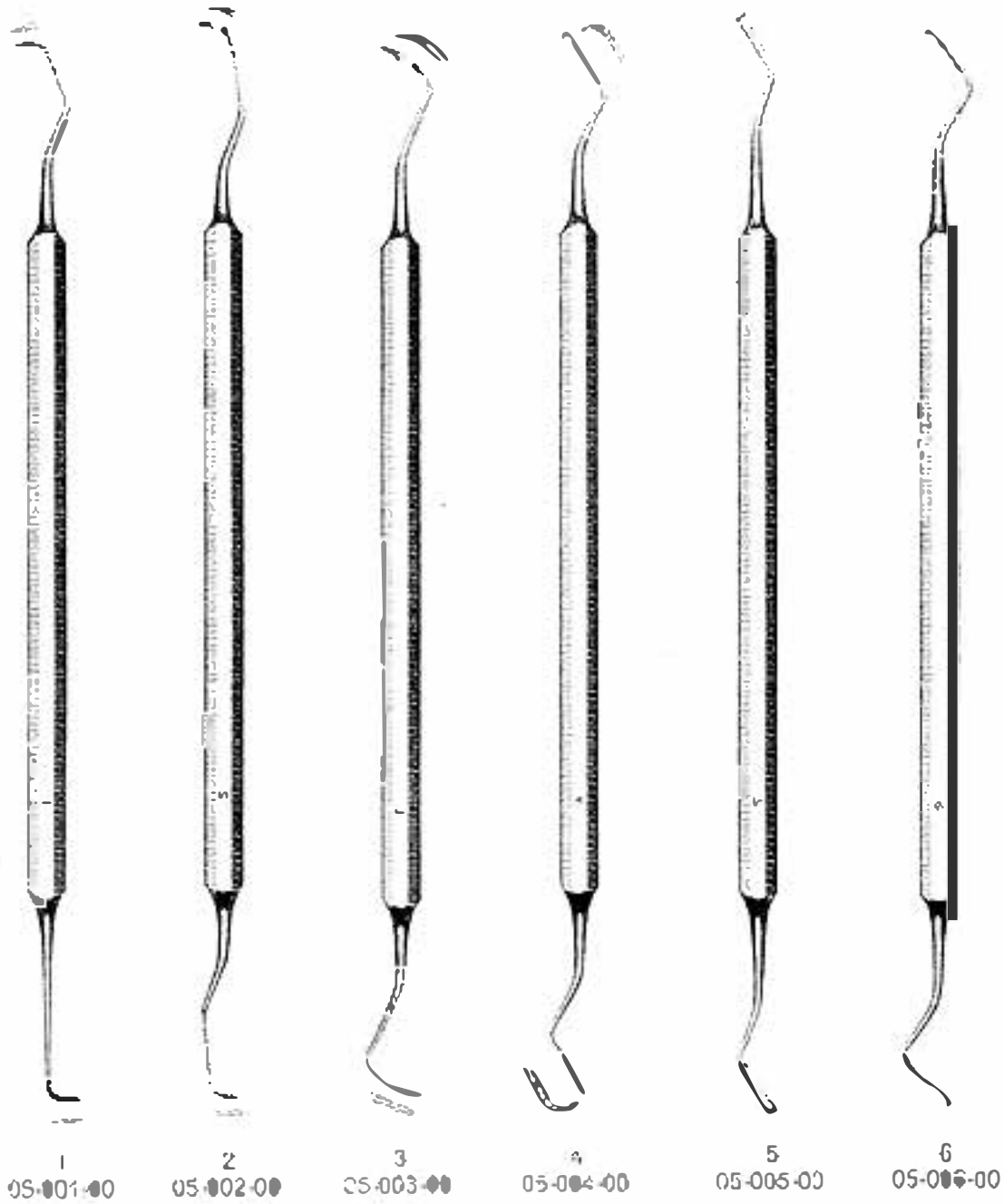



7  
05-007-00



8  
05-008-00



9  
05-009-00



10  
05-010-00



11  
05-011-00



05-012-00



PERIODONTAL INSTRUMENTS  
INSTRUMENTE FÜR DIE PARODONTOLOGIE  
INSTRUMENTSOS PARA PERIODONCIA

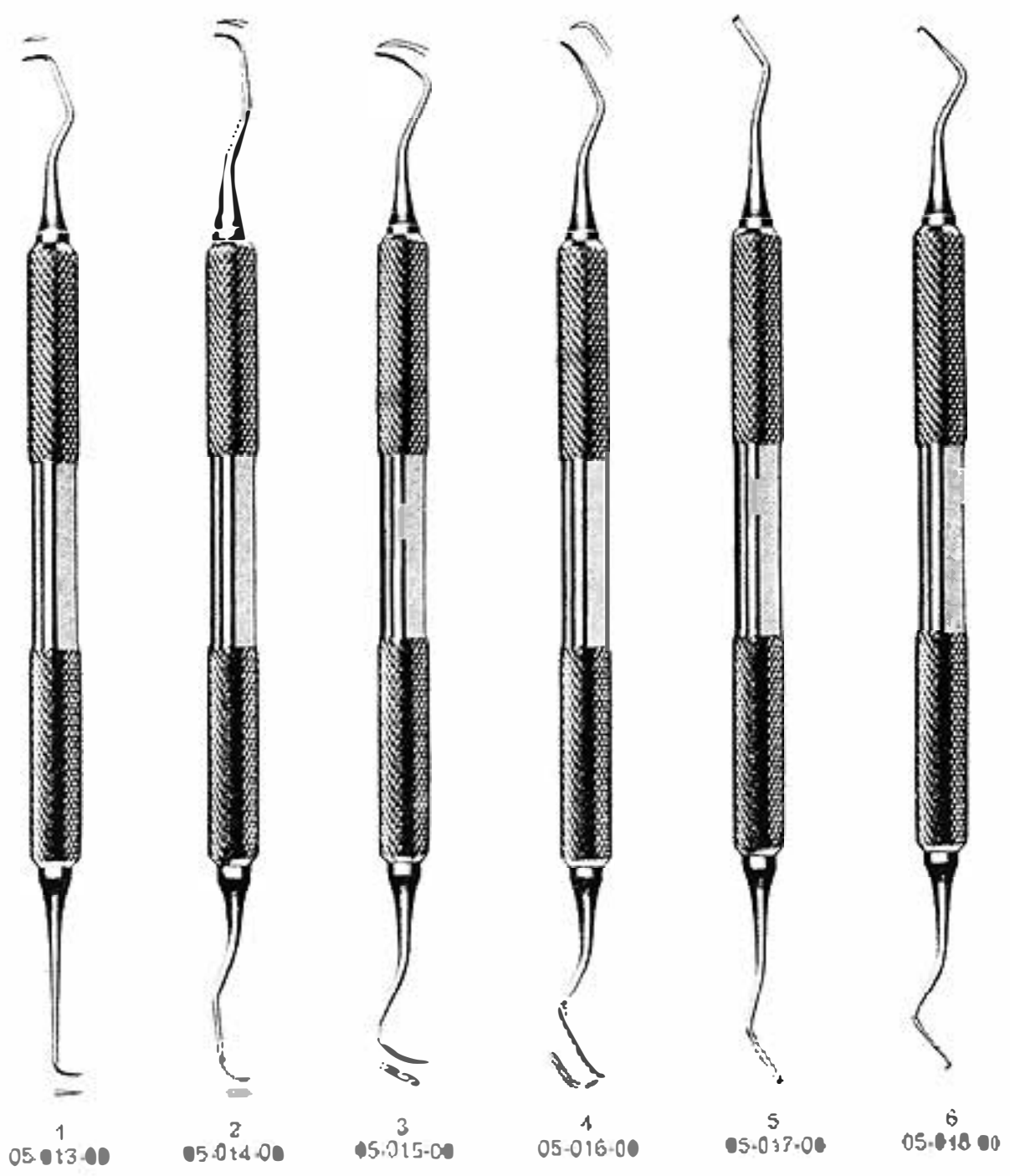

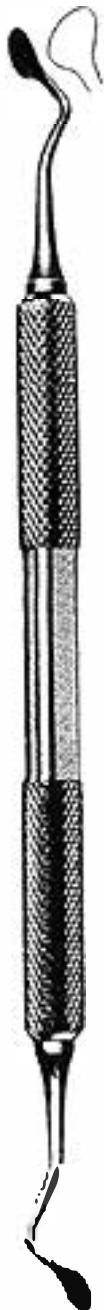

7  
05-019-00



8  
05-020-00



9  
05-021-00



10  
05-022-00



11  
05-023-00

PERIODONTAL INSTRUMENTS  
INSTRUMENTE FÜR DIE PARODONTOLOGIE  
INSTRUMENTOS PARA PERIODONCIA

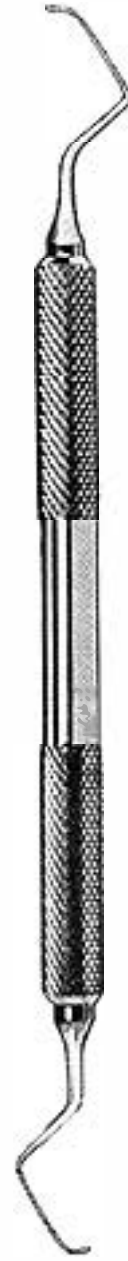
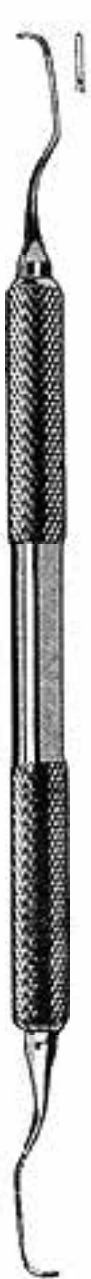

1-2  
05-024-00  
Subgingival

3-4  
05-025-00

5-6  
05-026-00

7-8  
05-027-00

9-10  
05-028-00

11-12  
05-029-00

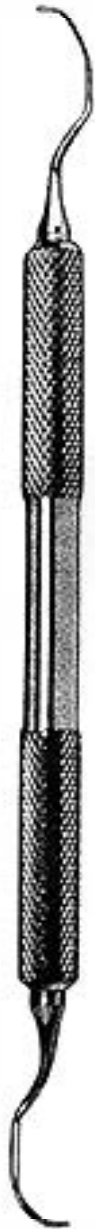

13.14  
05-030-00

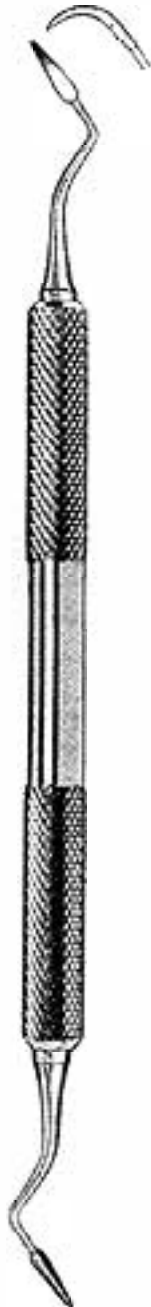

CK 6  
05-031-00  
Crane Kaplan



H6-H7  
05-032-00

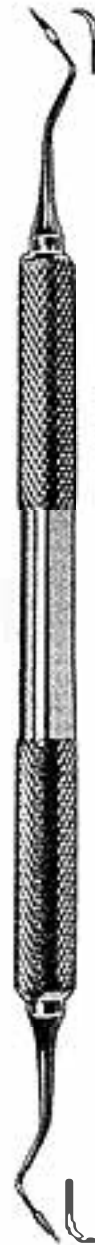

T2-T3  
05-033-00  
Taylor

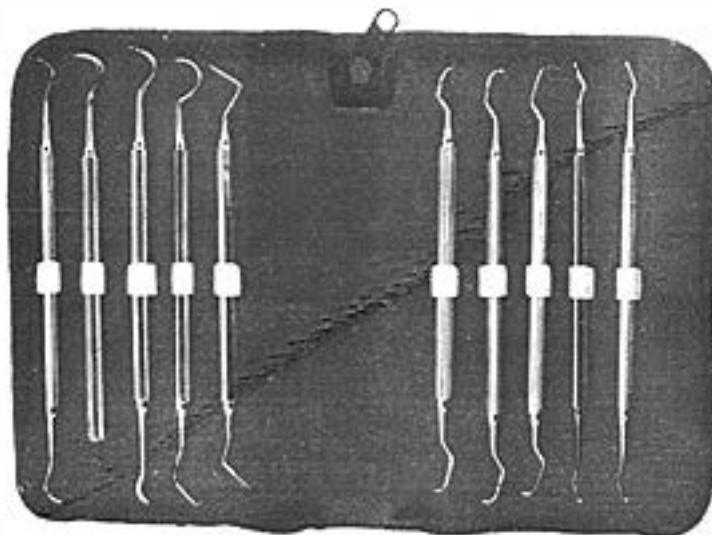

05-034-00

Subgingival Curette Set Consisting Of: 10 Pieces

- 1- Goldman fox pucker probe double ended
- 1- Explorer, double ended # 5
- 1- Jaquette scaler, single ended # 15
- 1- Jaquette scaler, double ended # U 15/33
- 1- McCall curette, double ended # 17S/18S
- 1- Lanjar curette, double ended # L 3/8
- 1- Lanjar curette, double ended # L 3/8
- 1- Lanjar curette, double ended # L 5/8
- 1- Periodontal curette, double ended; # H 3/7
- 1- Periodontal curette, double ended # H 5/11

Department

06

SCALERS  
ZAHNREINIGER  
LIMPIODORES DE SARRO

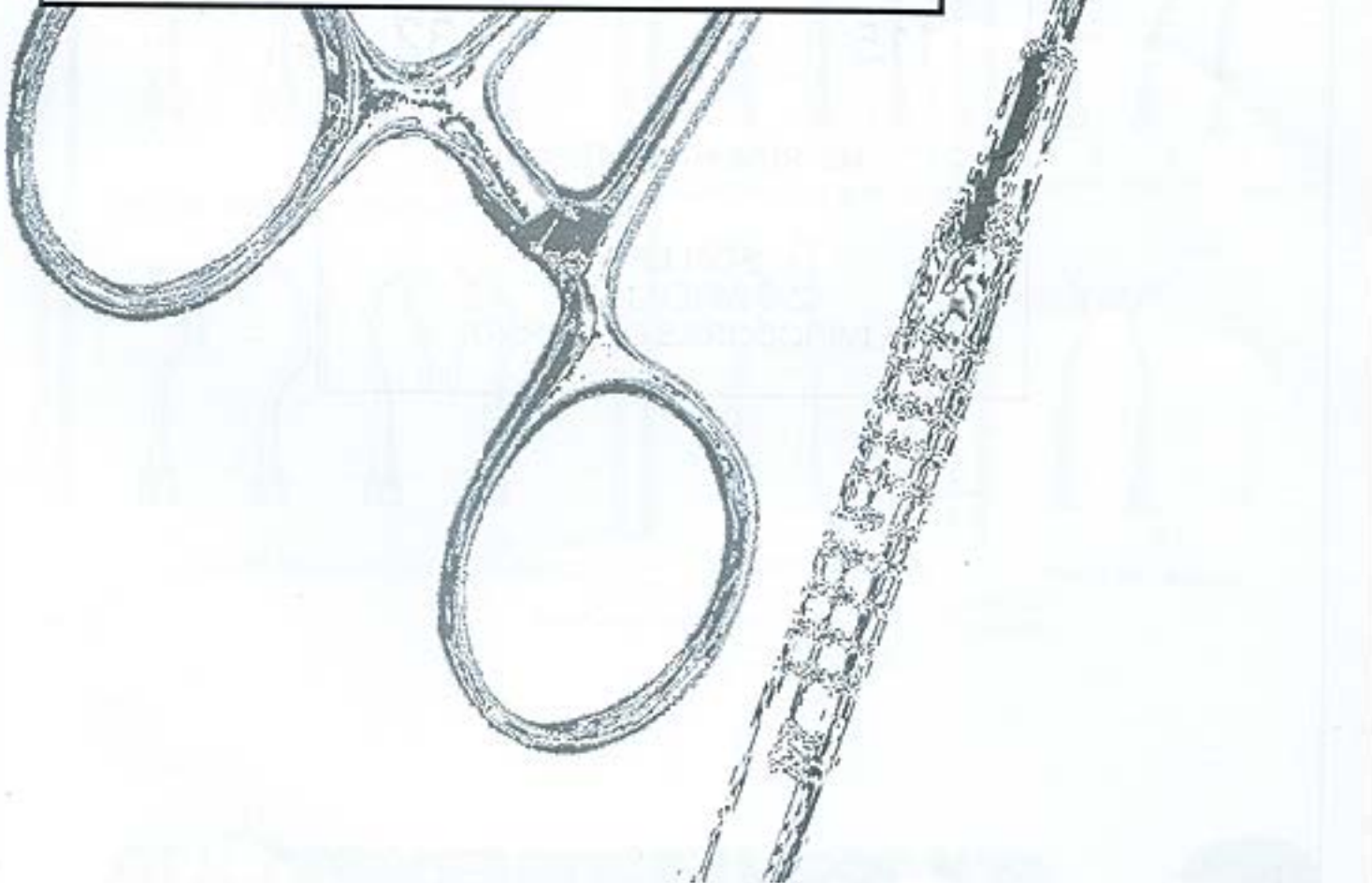
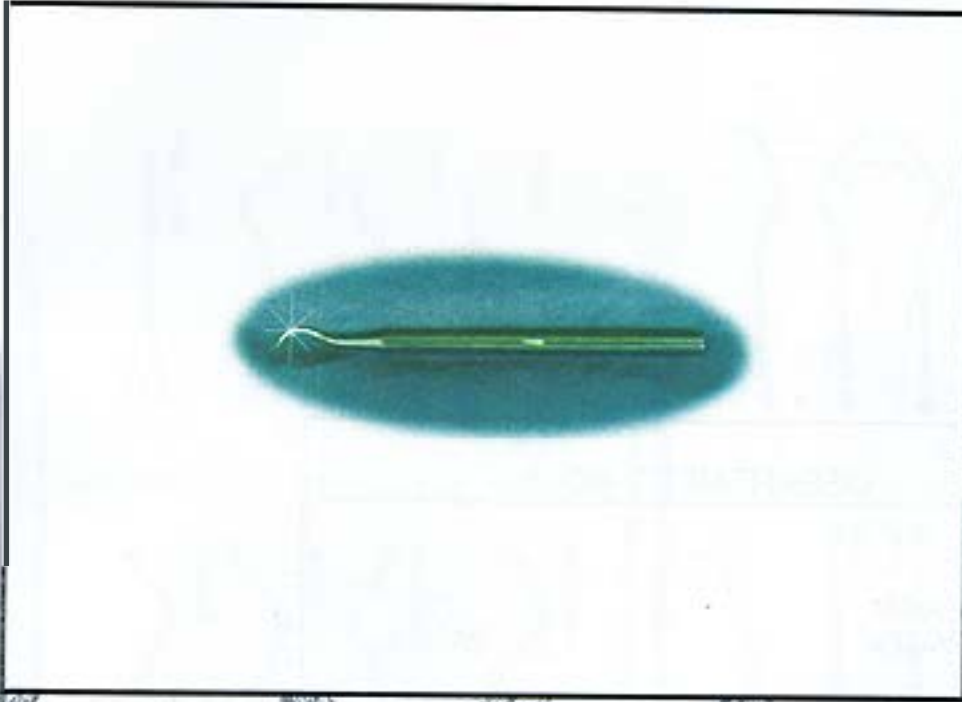

DEPARTMENT NO. 6

FROM  
PAGE#

TO  
PAGE#

115

132

INSTRUMENTS CATEGORY

SCALERS  
ZAHNREINIGER  
LIMPIODORES DE SARRO

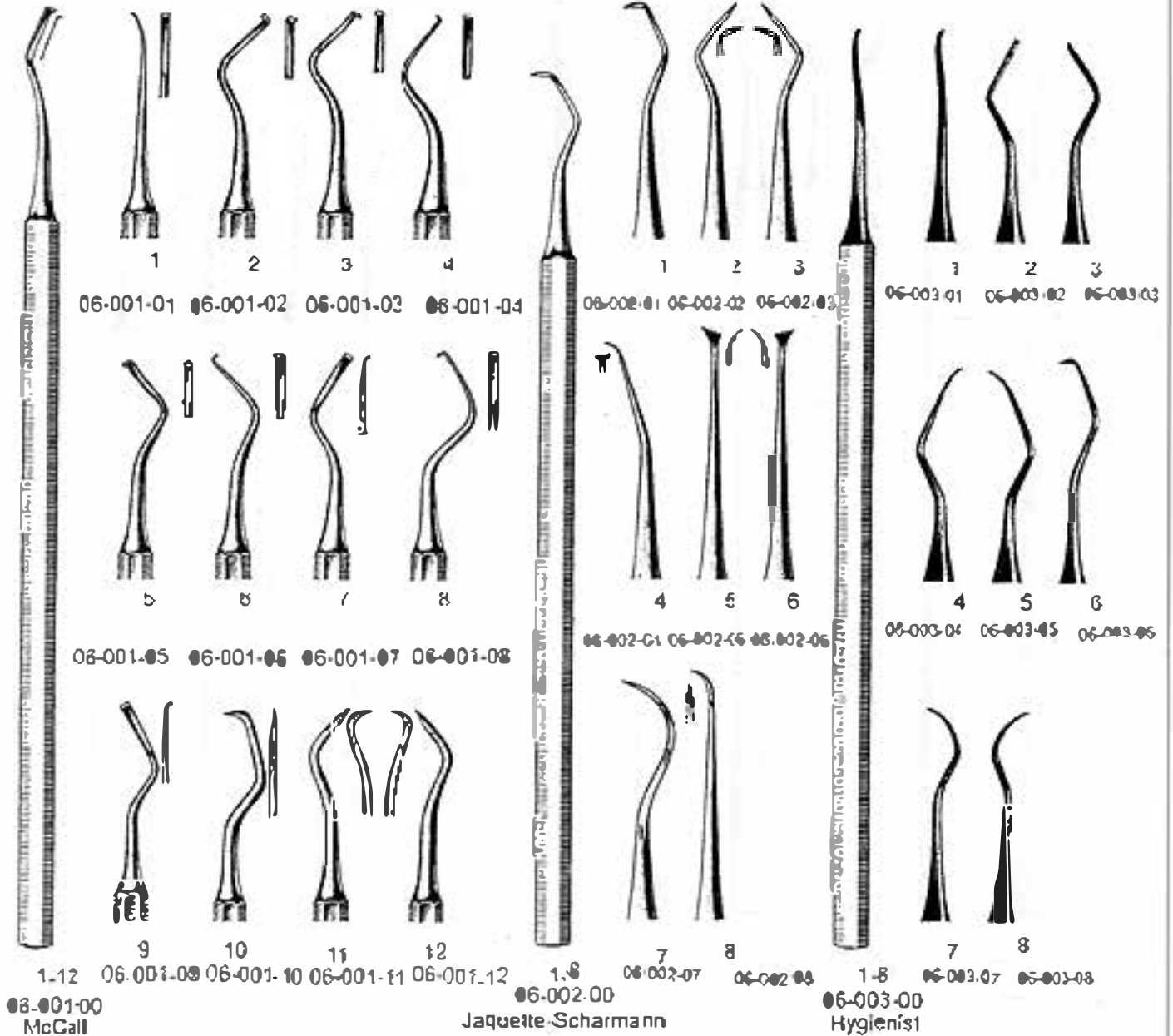



SCALERS  
ZAHNREINIGER  
LIMPIODORES DE SARRO

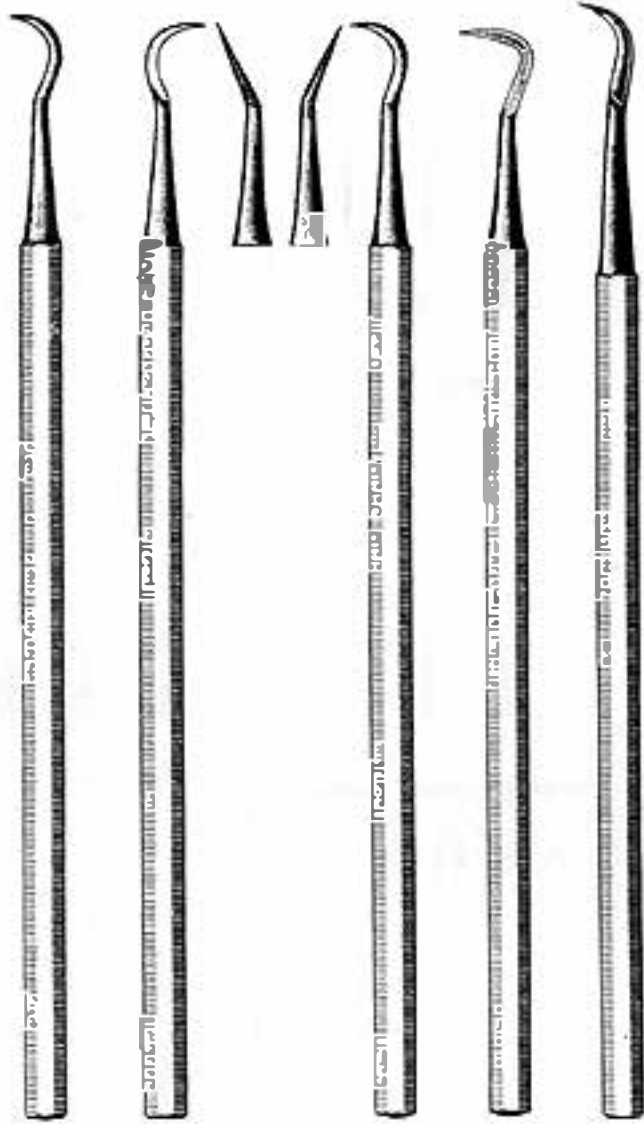

70 06-004-00  
71 06-005-00  
72 06-006-00  
73 06-007-00  
1 06-008-00

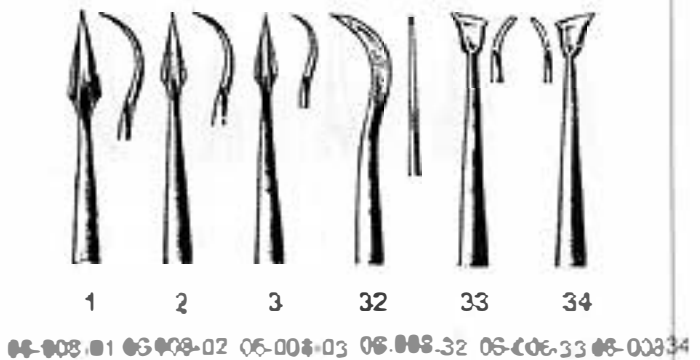

1 06-008-01  
2 06-008-02  
3 06-008-03  
32 06-008-32  
33 06-008-33  
34 06-008-34

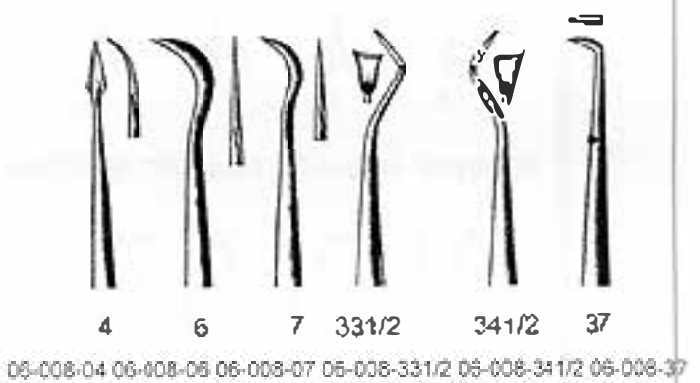

4 06-008-04  
6 06-008-06  
7 06-008-07  
33 1/2 06-008-33 1/2  
34 1/2 06-008-34 1/2  
37 06-008-37

SCALERS  
 INSTRUMENTS A DETARTRER  
 LIMPIADORES DE SARRO

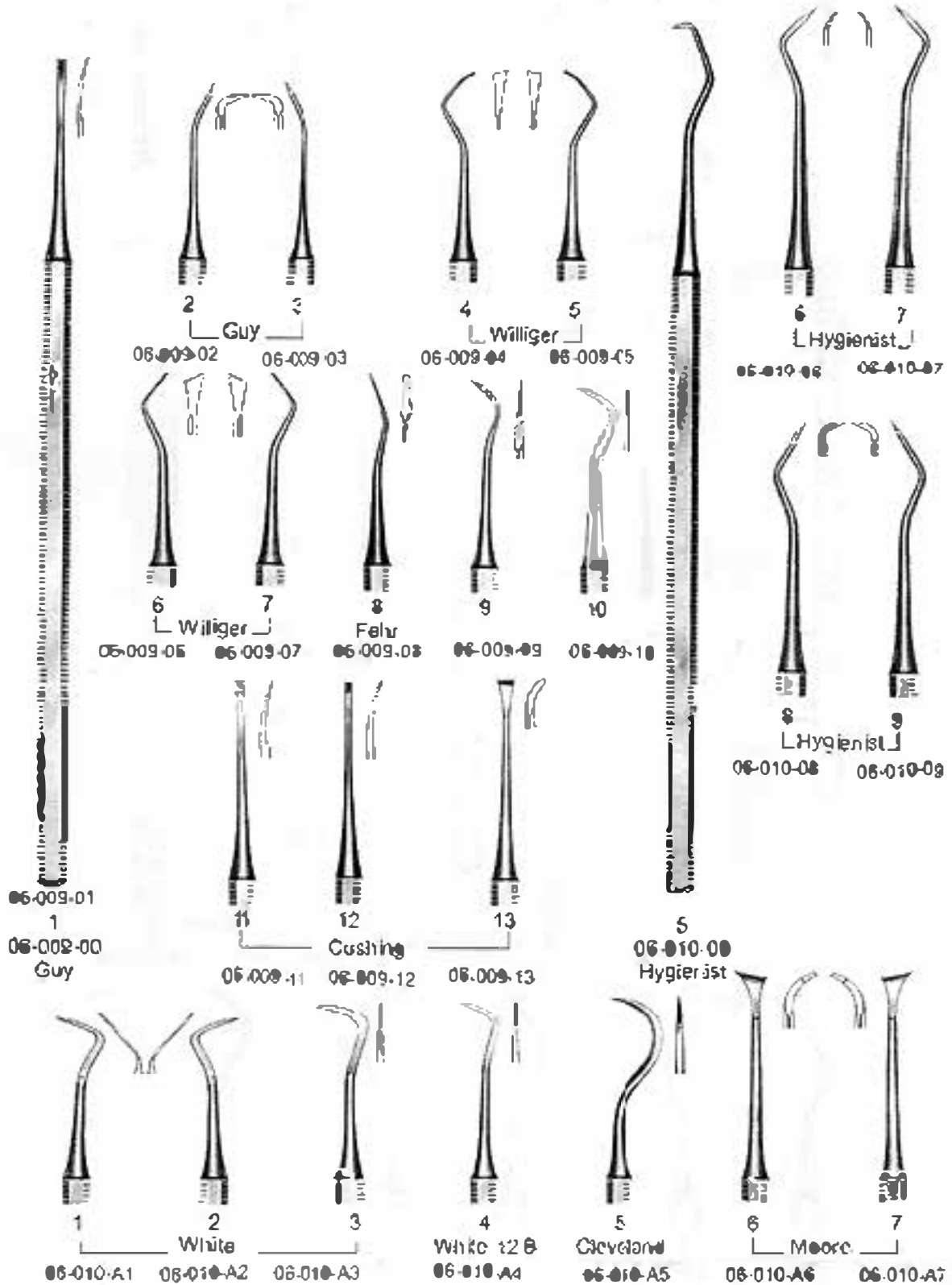

SCALERS  
INSTRUMENTS A DETARTRER  
LIMPIADORES DE SARRO

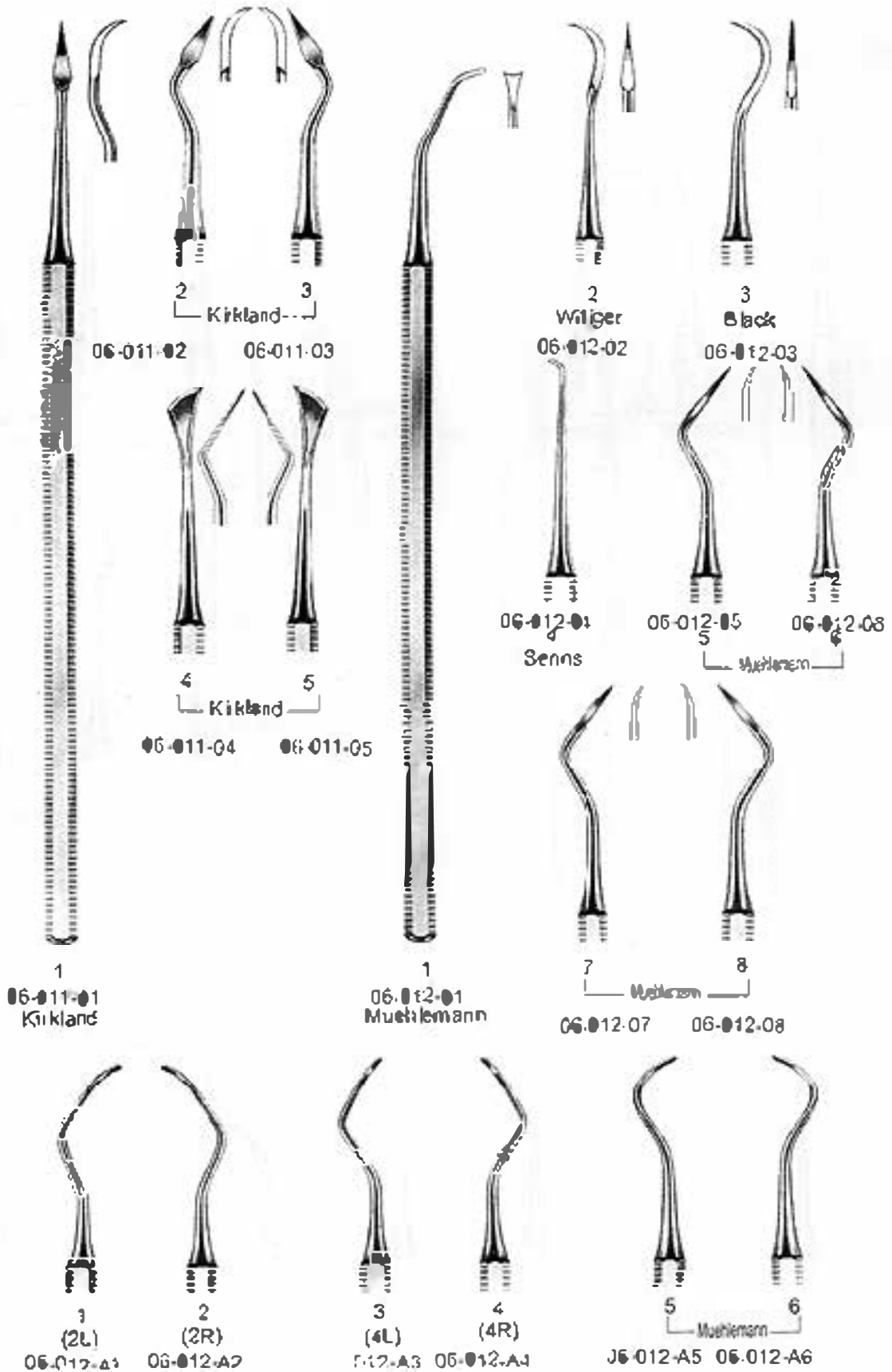

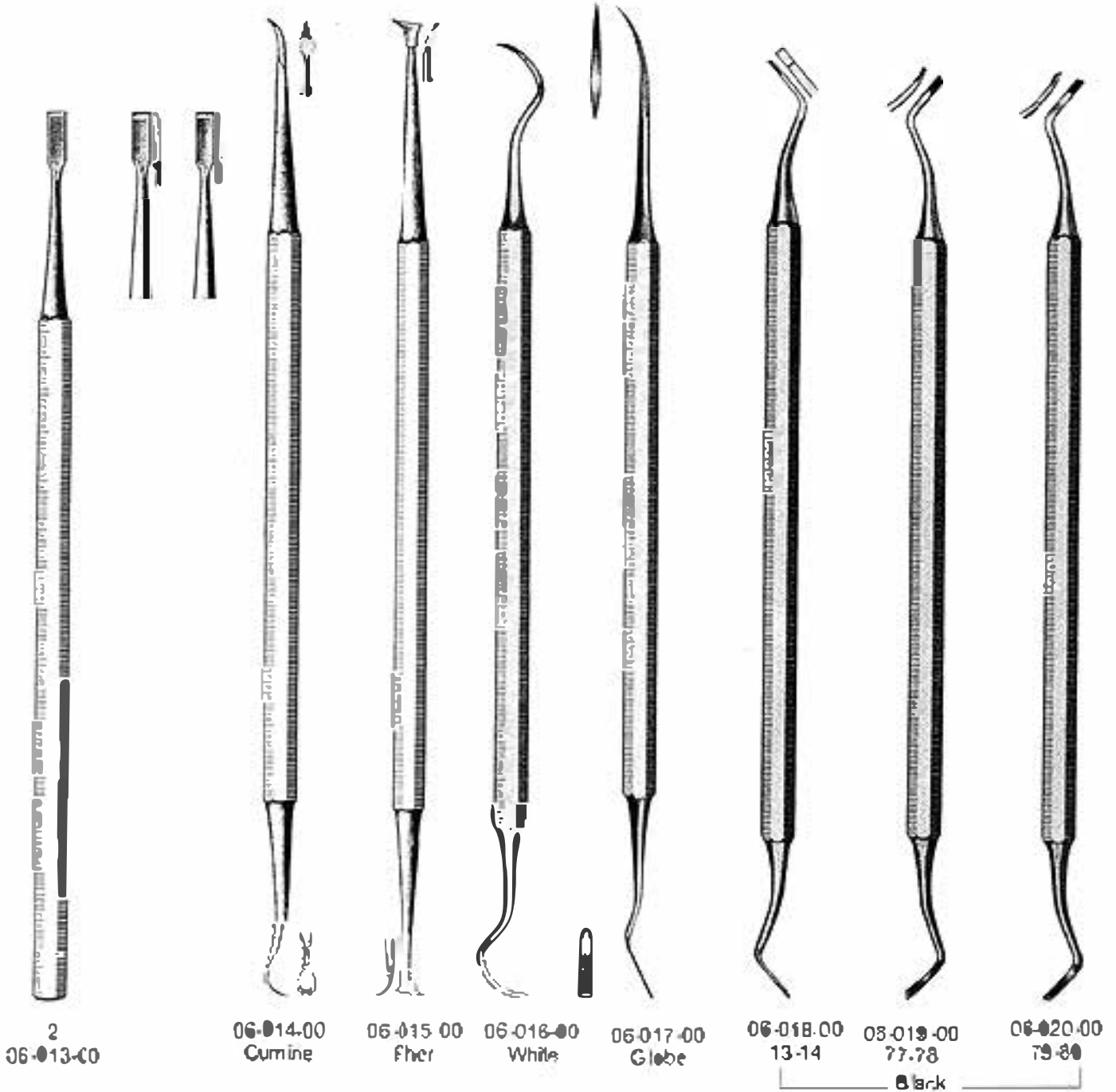

# SCALERS INSTRUMENTS A DETARTRER LIMPIADORES DE SARRO

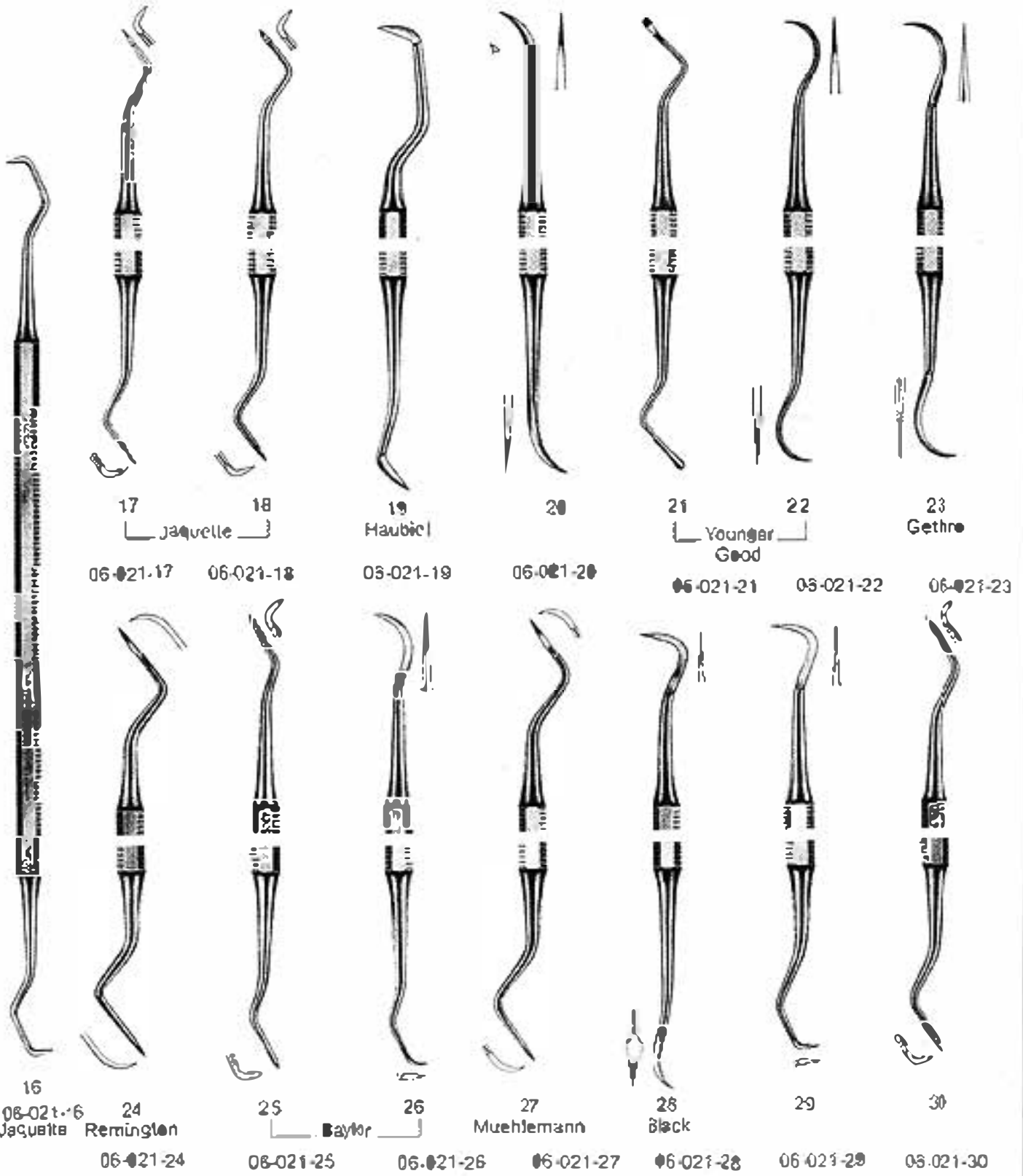

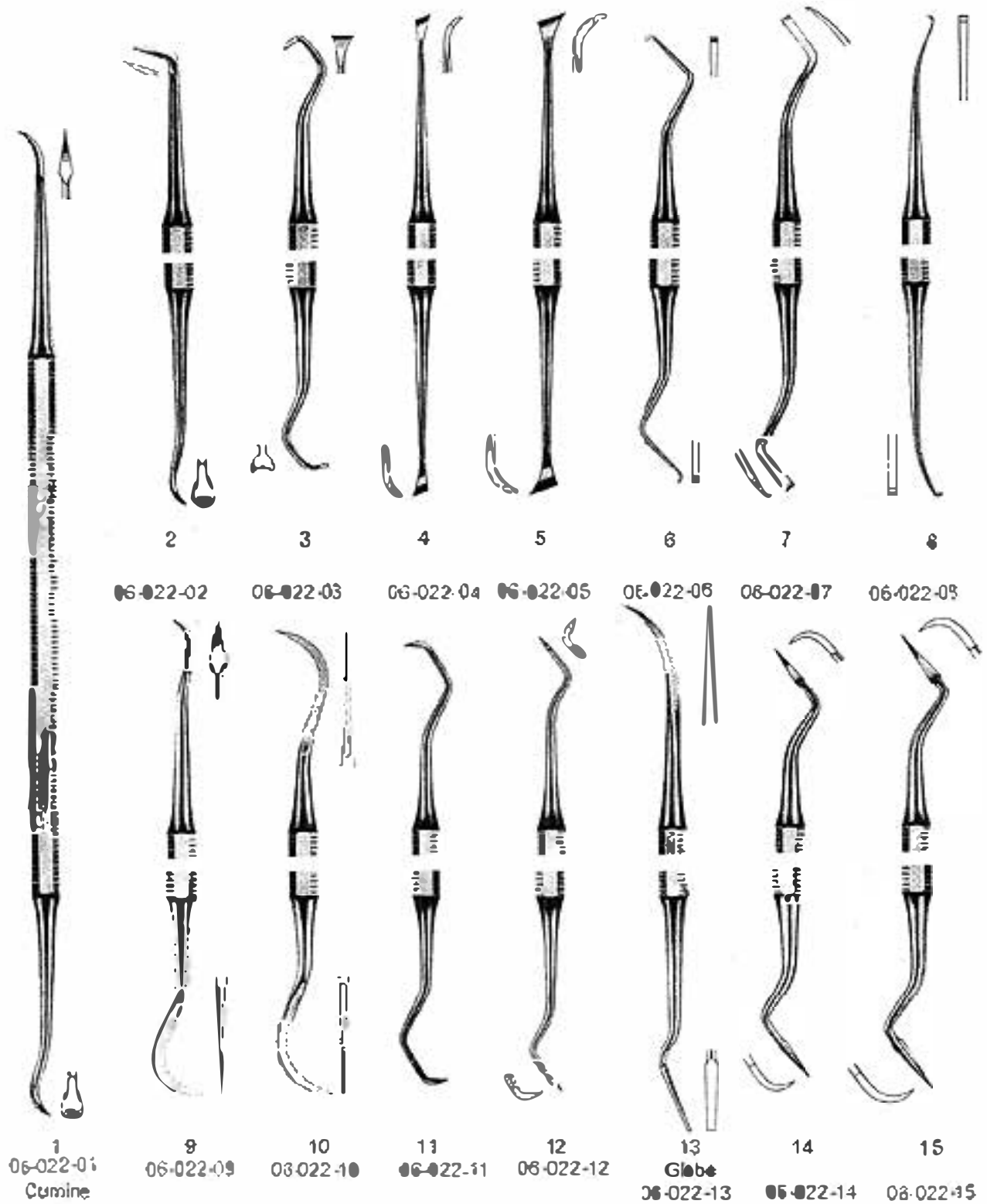

# SCALERS INSTRUMENTS A DETARTRER LIMPIODORES DE SARRO

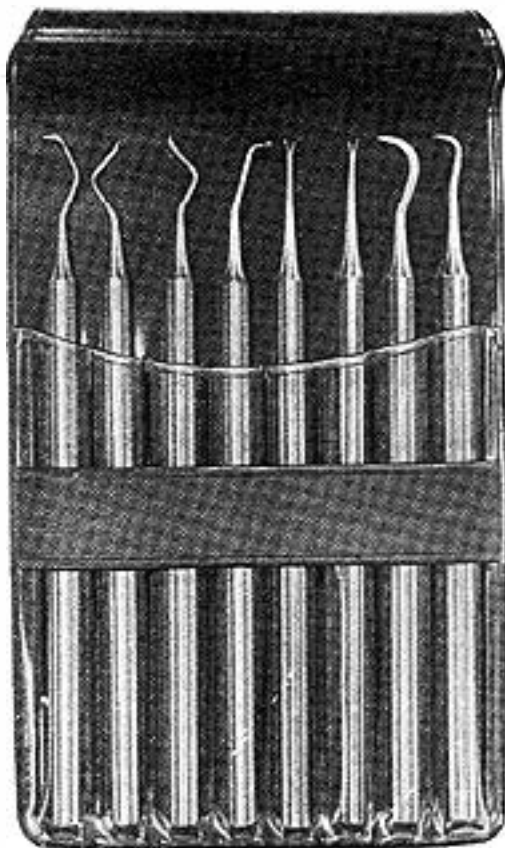

06-023-00

Set of Scalers, comprising  
Figs. 06-024-01 to 06-024-08 in  
black plastic wallet.



1  
06-024-01

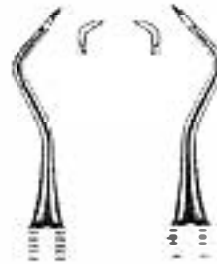

2  
06-024-02

3  
06-024-03



4  
06-024-04



5  
06-024-05



6  
06-024-06



7  
06-024-07



8  
06-024-08

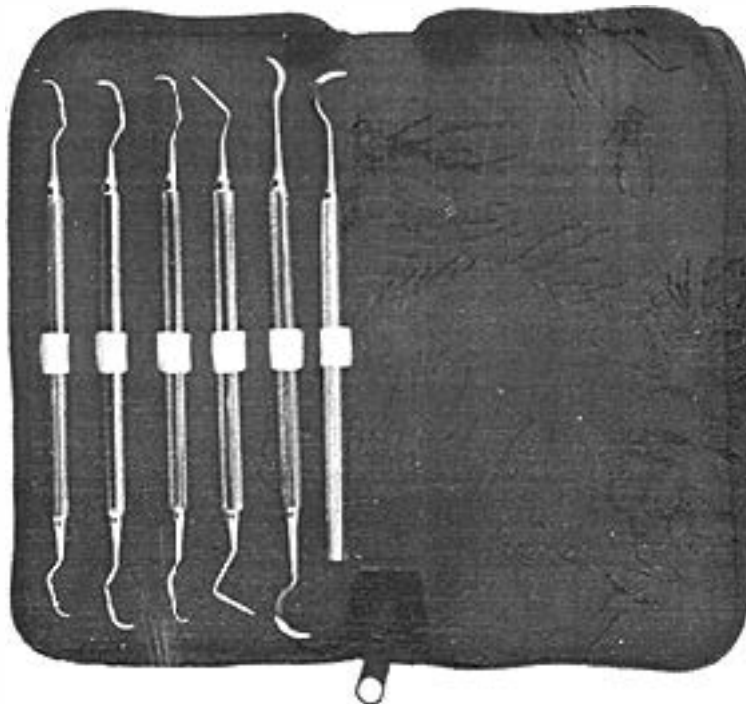
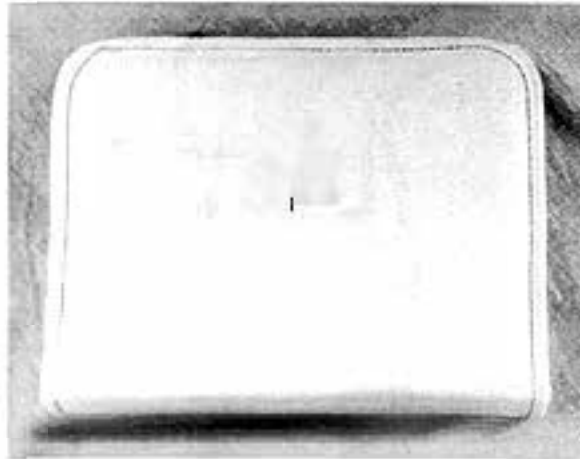

06-025-00  
Scaling Set

- 1- Goldman fox pocket probe, double ended.
- 1- Jaquette scaler, single ended # 15
- 1- Jaquette scaler, double ended # U 15/33
- 1- Langer curette, double ended # L 1/2
- 1- Langer curette, double ended # L 3/4
- 1- Langer curette, double ended # L 5/6



PERIODONTAL CURETTS  
SICKLE-SCALERS  
CURETAS



2-3  
06-026-00



5-6  
06-027-00



11  
06-028-00



2-3  
06-029-00



6  
06-030-00



6  
06-031-00



6  
06-032-00



4  
06-033-00



1  
06-034-00



1  
06-035-00

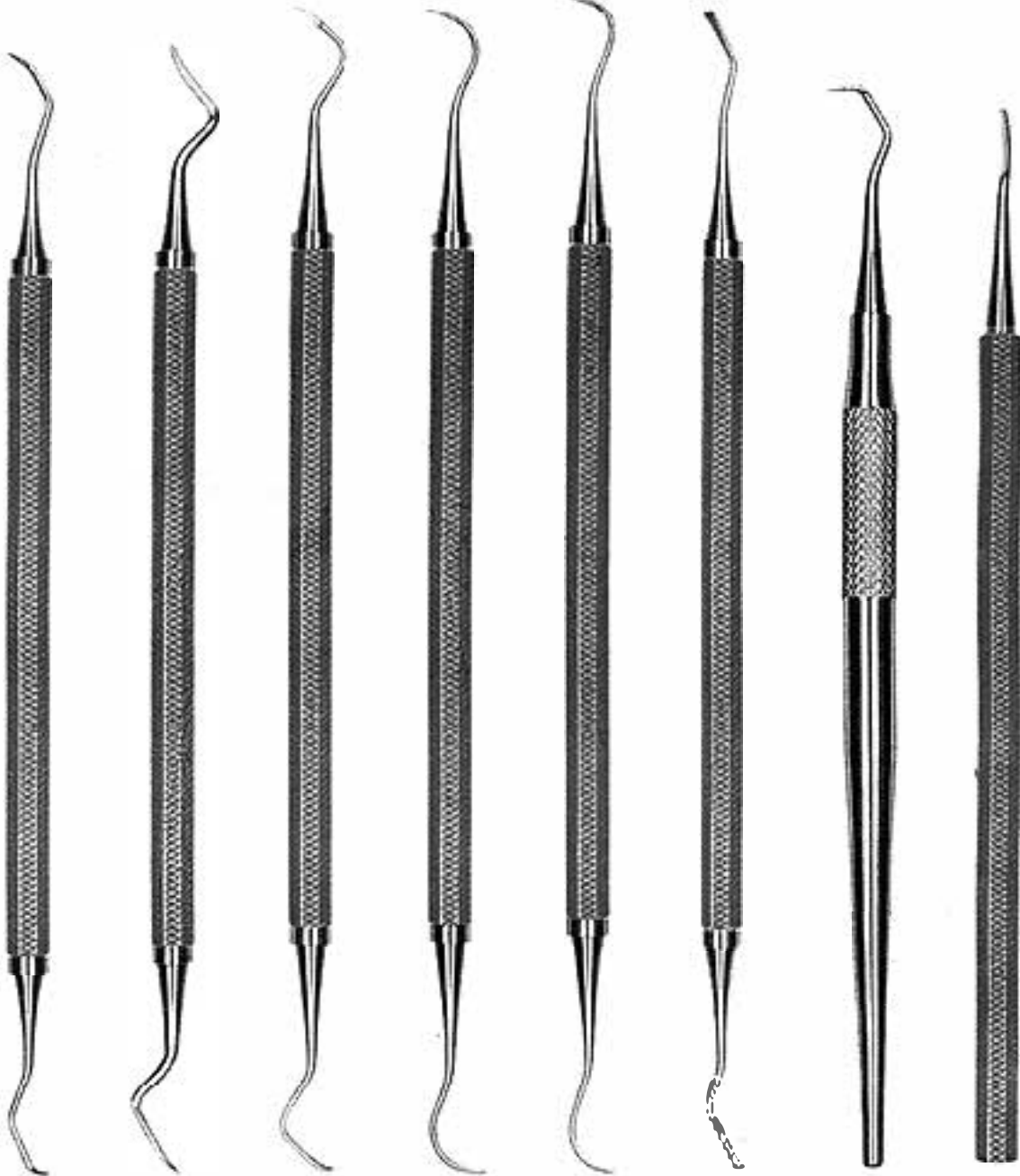

11/12  
06-037-00

11A/12A  
06-038-00

13S/14S  
06-033-00

17S/18S  
06-040-00

19/20  
06-041-00

7/9  
06-042-00  
Hoe

10  
06-043-00

1  
06-044-00  
Chisel

CURETTES  
KURETTEN  
CURETAS



GF-1  
06-045-00



GF-4  
06-046-00



GF-3  
06-047-00



GF-2  
06-048-00



GF-8  
06-049-00



GF-5  
06-050-00



GF-21  
06-051-00



GF-21S  
06-052-00





3/7  
06-053-00



5/11  
06-054-00



U15/33+  
06-055-00



17S/14S+  
06-058-00

CURETTES  
LOFFEL  
CURETAS OSEAS



1/2  
08-057-00



3/4  
06-058-00



5/6  
06-059-00



7/8  
06-060-00



9/10  
06-061-00



11/12  
06-062-00



13/14  
06-063-00



15/16  
06-064-00

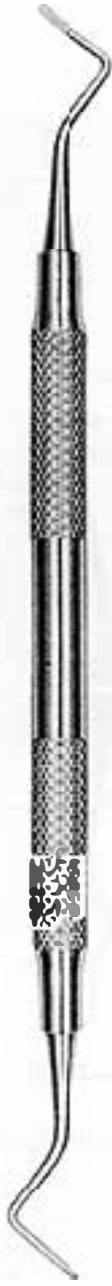

101/102  
06-065-00



103/106  
06-066-00



104/105  
06-067-00

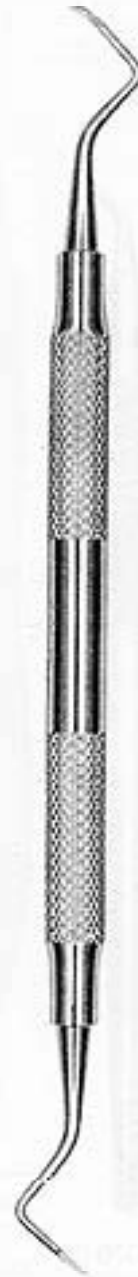

107/108  
06-068-00

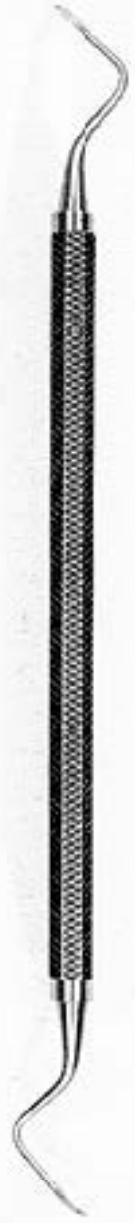

107/108S  
06-069-00  
Modified

CURETTES  
LOFFEL  
CURETAS OSEAS

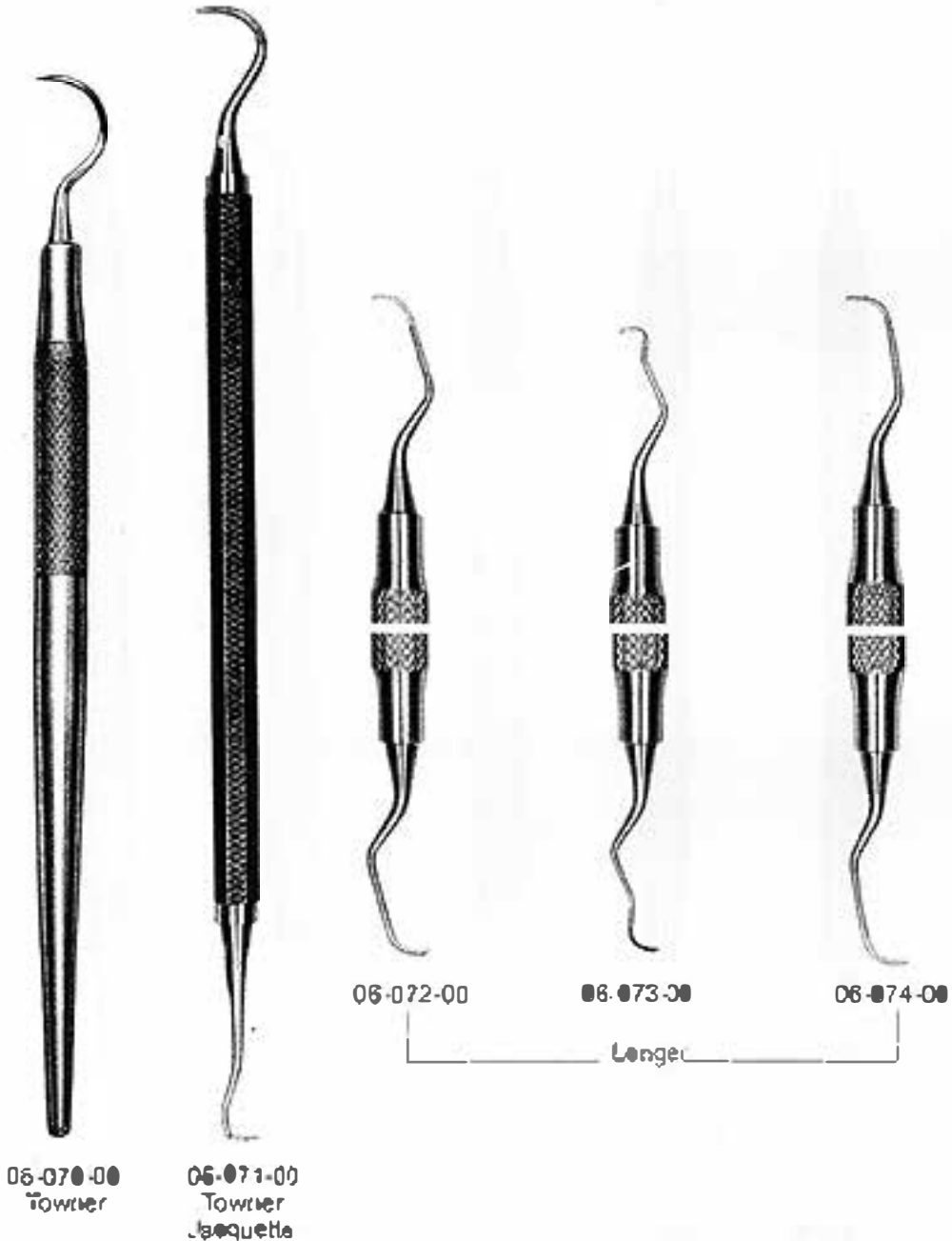

# MAX GRIP

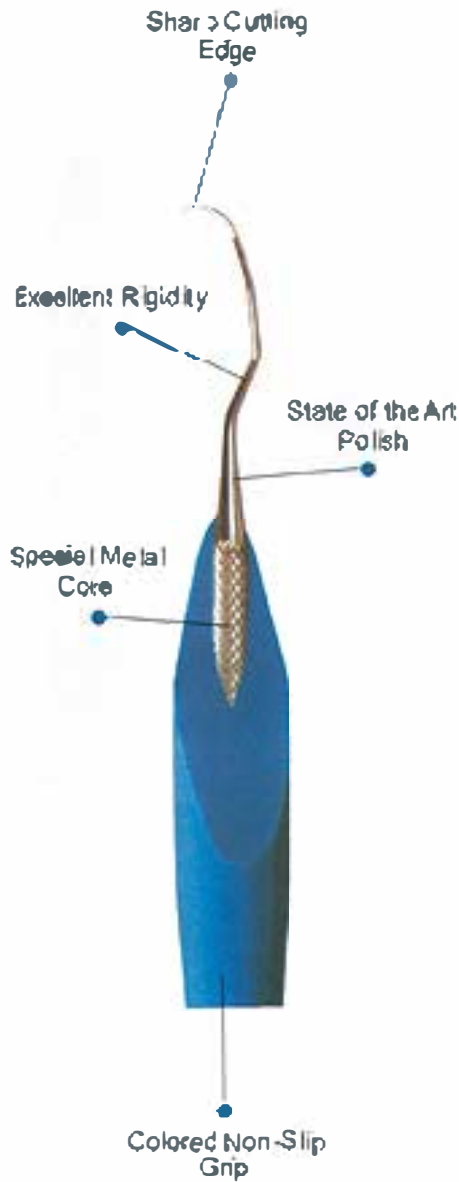

● overall light weight structure

MAX GRIP Instruments can be sterilized / autoclaved upto 200°C  
 All other type of periodontal curettas & hand instruments including explorers filling instruments etc. are available in MAX GRIP handles.



1/2  
 06.075-00



3/4  
 06.076-00



5/6  
 06.077-01



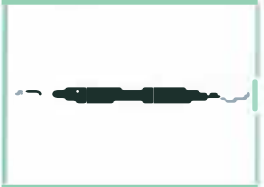

# MAX GRIP



7/8  
06-078-00



9/10  
06-079-00



11/12  
06-080-00



13/14  
06-081-00



15/16  
06-082-00

133A



CURETTES  
LOFFEL  
CURETAS OCEAS

06



Gracey  
1/2  
06-108-00



Gracey  
3/4  
06-109-00



Gracey  
5/8  
06-110-00



Gracey  
7/8  
06-111-00



Gracey  
9/10  
06-112-00



Gracey  
11/12  
06-113-00



Gracey  
13 1/2  
06-114-00

**NOTE: All other hand instruments are also available in this Hollow Handle**

133 B

Department

07

EXCAVATORS  
EXCAVATOREN  
EXCAVADORES

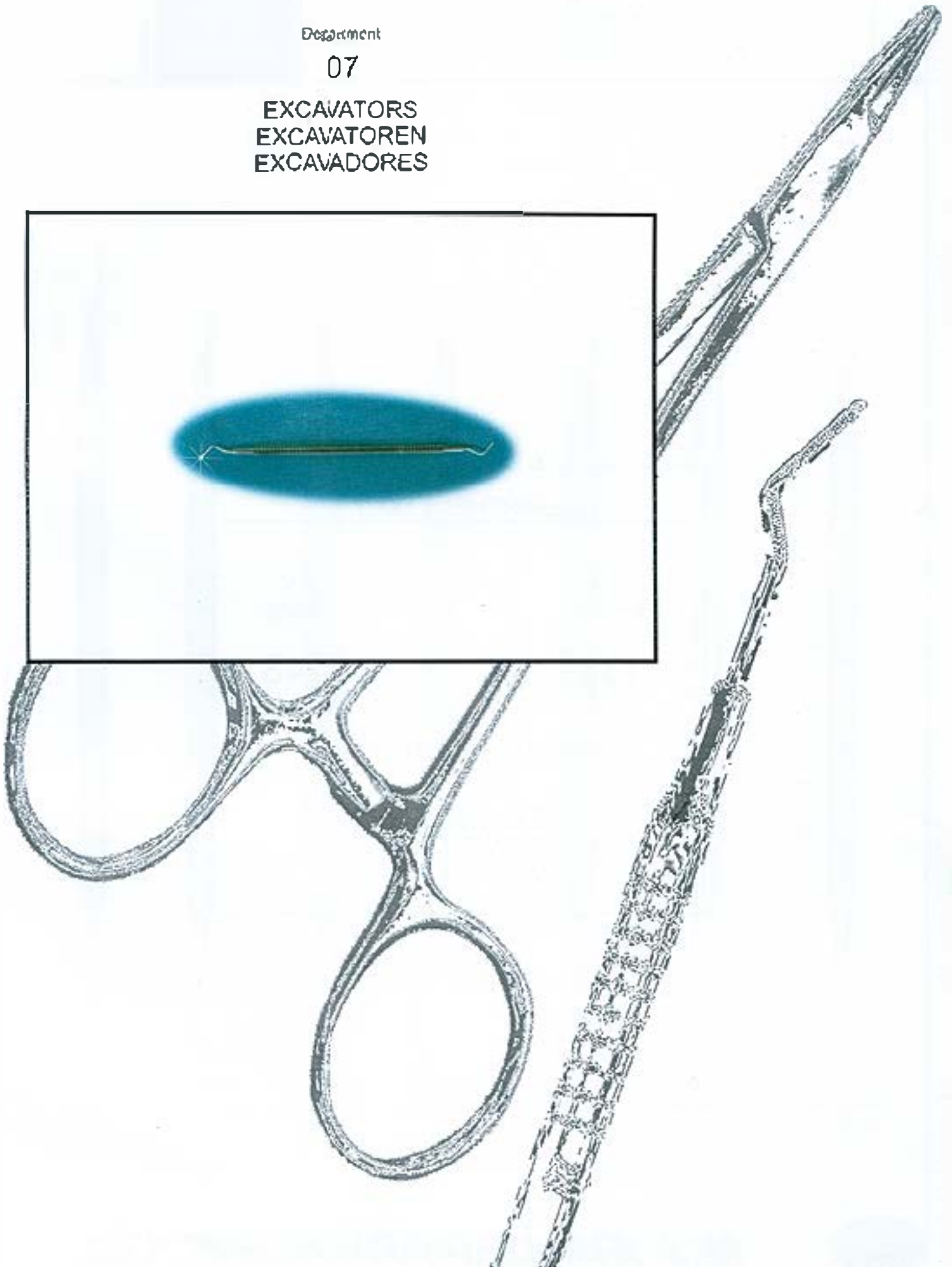
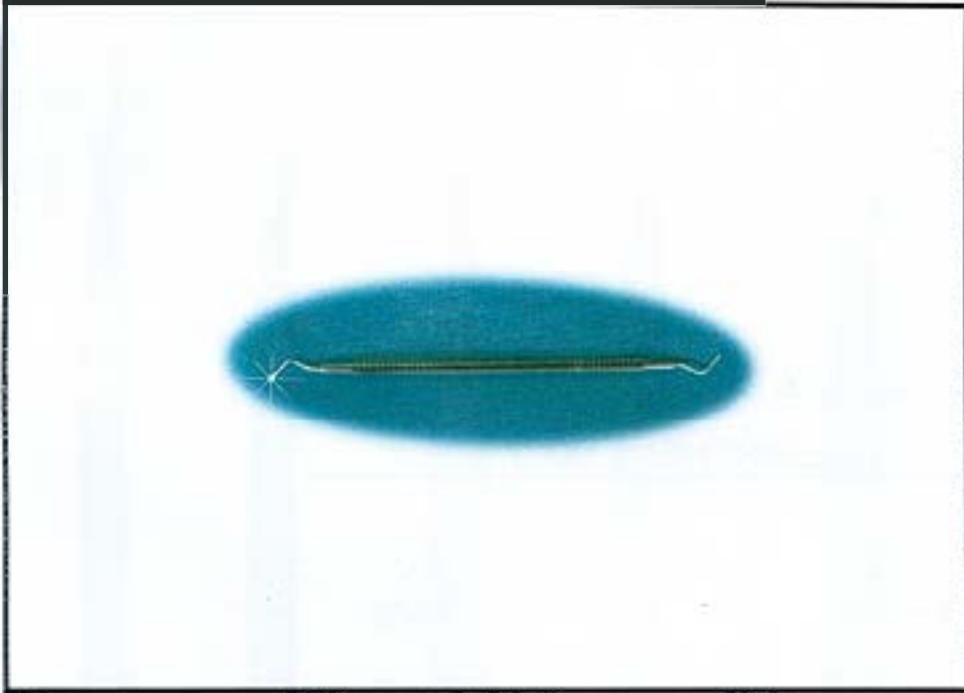

CURETTES  
LOFFEL  
CURETAS OCEAS

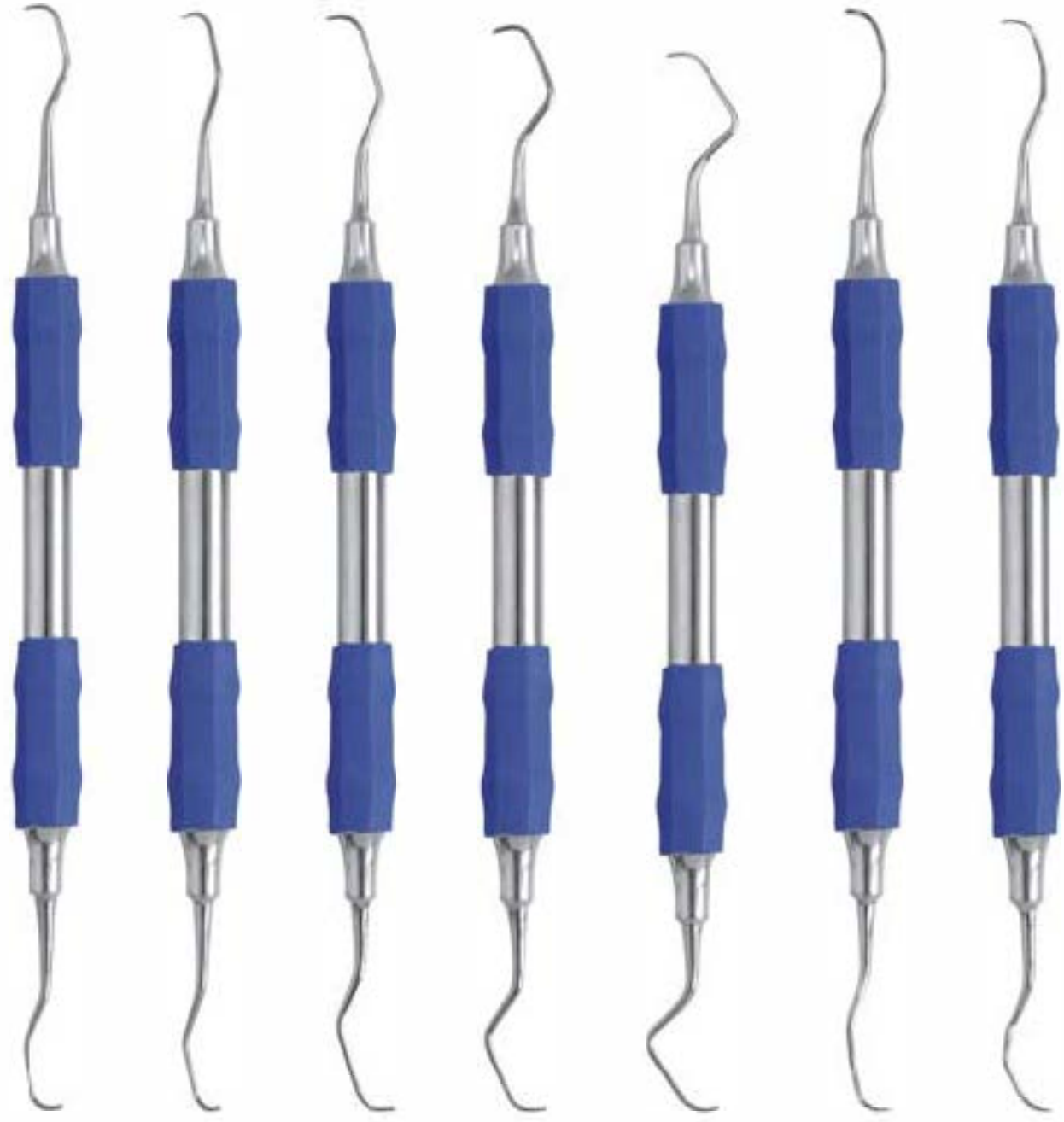

Gracey 1/2 06-120-00	Gracey 3/4 06-121-00	Gracey 5/8 06-122-00	Gracey 7/8 06-123-00	Gracey 9/10 06-124-00	Gracey 11/12 06-125-00	Gracey 13/14 06-126-00
----------------------------	----------------------------	----------------------------	----------------------------	-----------------------------	------------------------------	------------------------------

**NOTE: All other hand instruments are also available in SOFTHOLD Handle**

DEPARTMENT NO. 7

---

FROM  
PAGE#

133

TO  
PAGE#

143

INSTRUMENTS CATEGORY

EXCAVATORS  
EXCAVATOREN  
EXCAVADORES

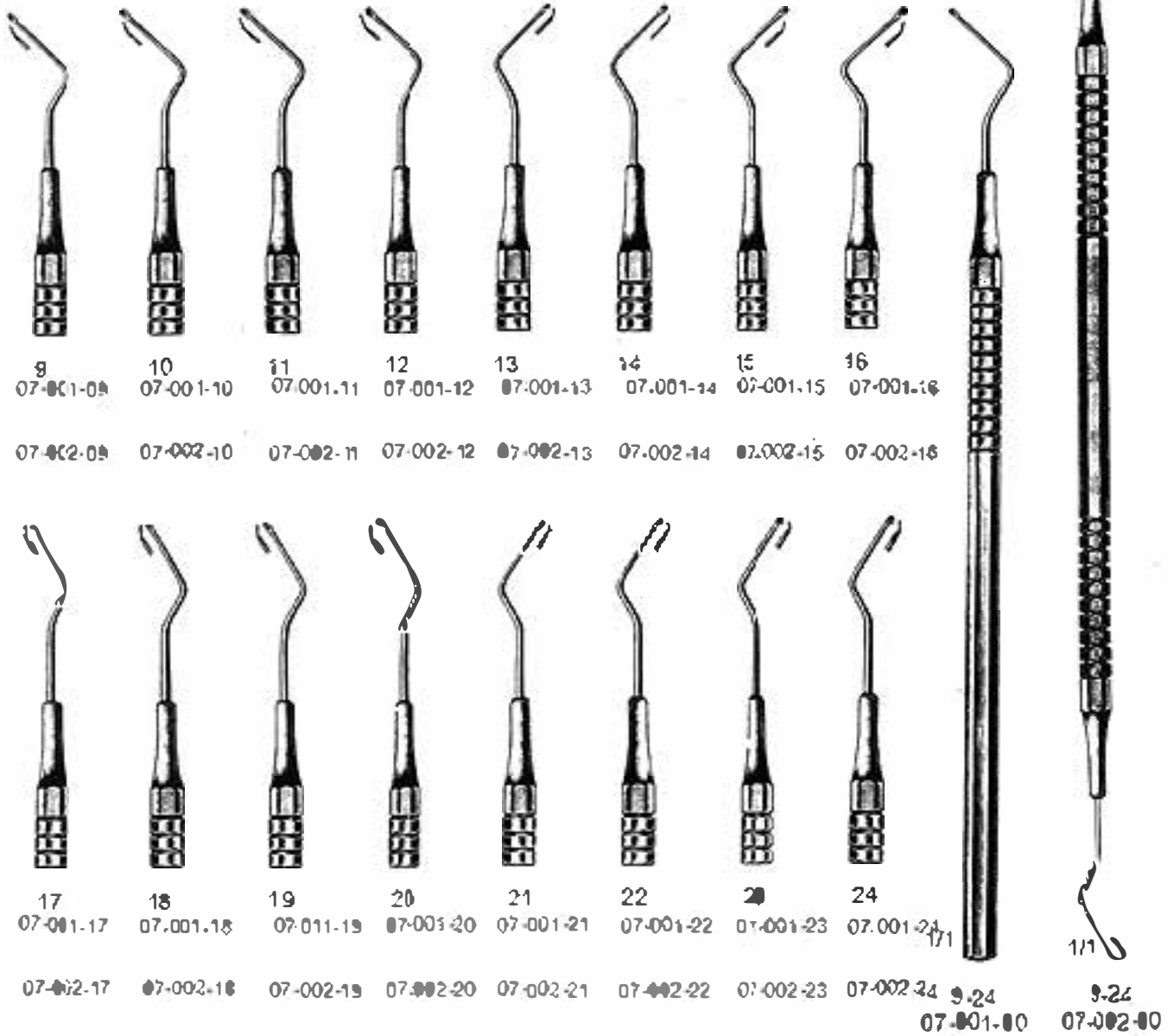

EXCAVATORS  
EXCAVATOREN  
EXCAVADORES



51-52  
07-003-00



57-58  
07-004-00



63-64  
07-005-00



75-76  
07-006-00



81-82  
07-007-00



17-21  
07-008-00



18-22  
07-009-00



18-23  
07-010-00

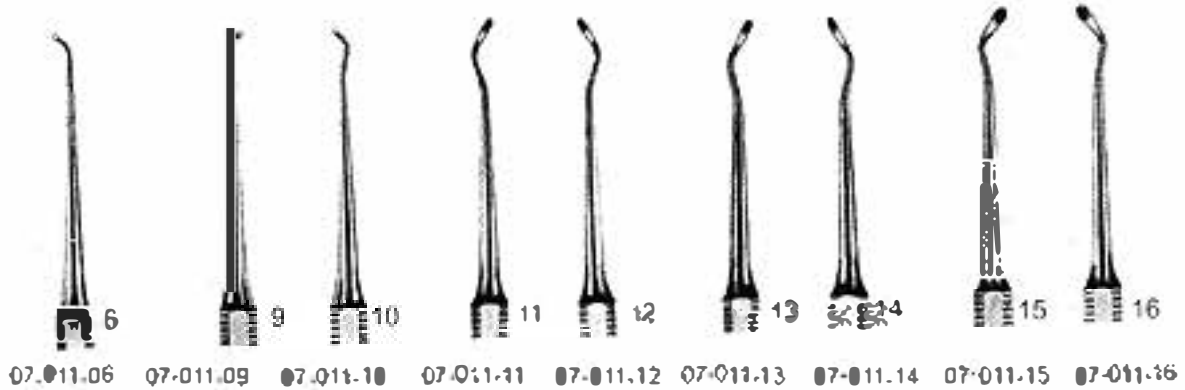

Darby-Perry

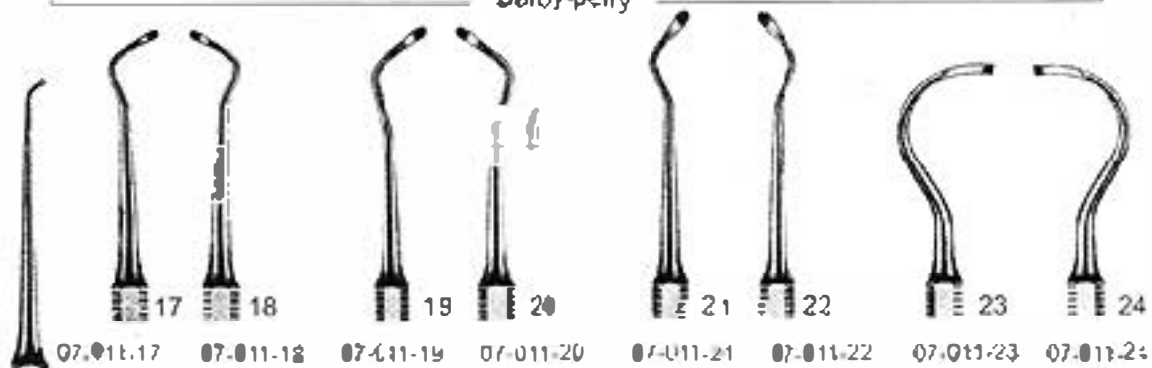

Darby-Perry

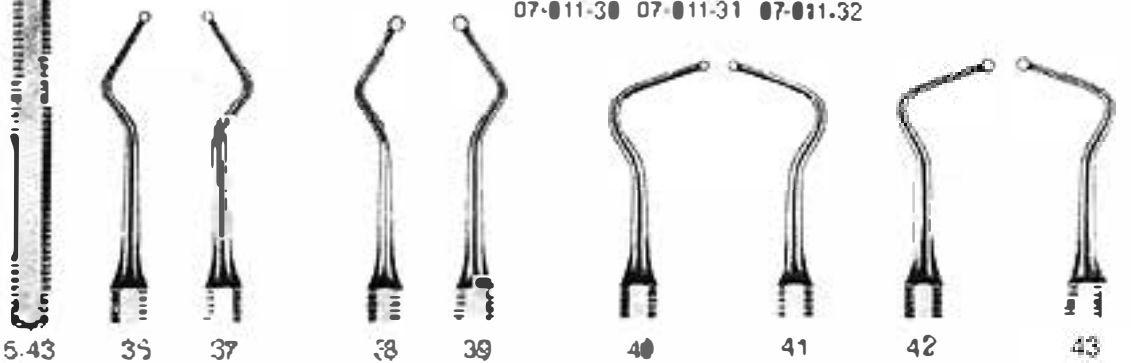
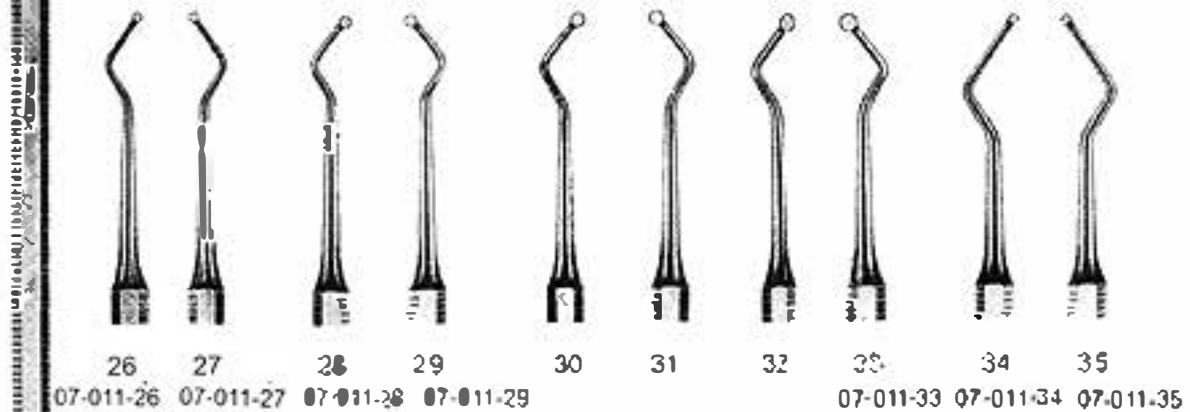

07-011-00  
Darby-Perry



EXCAVATORS  
EXCAVATOREN  
EXCAVADORES

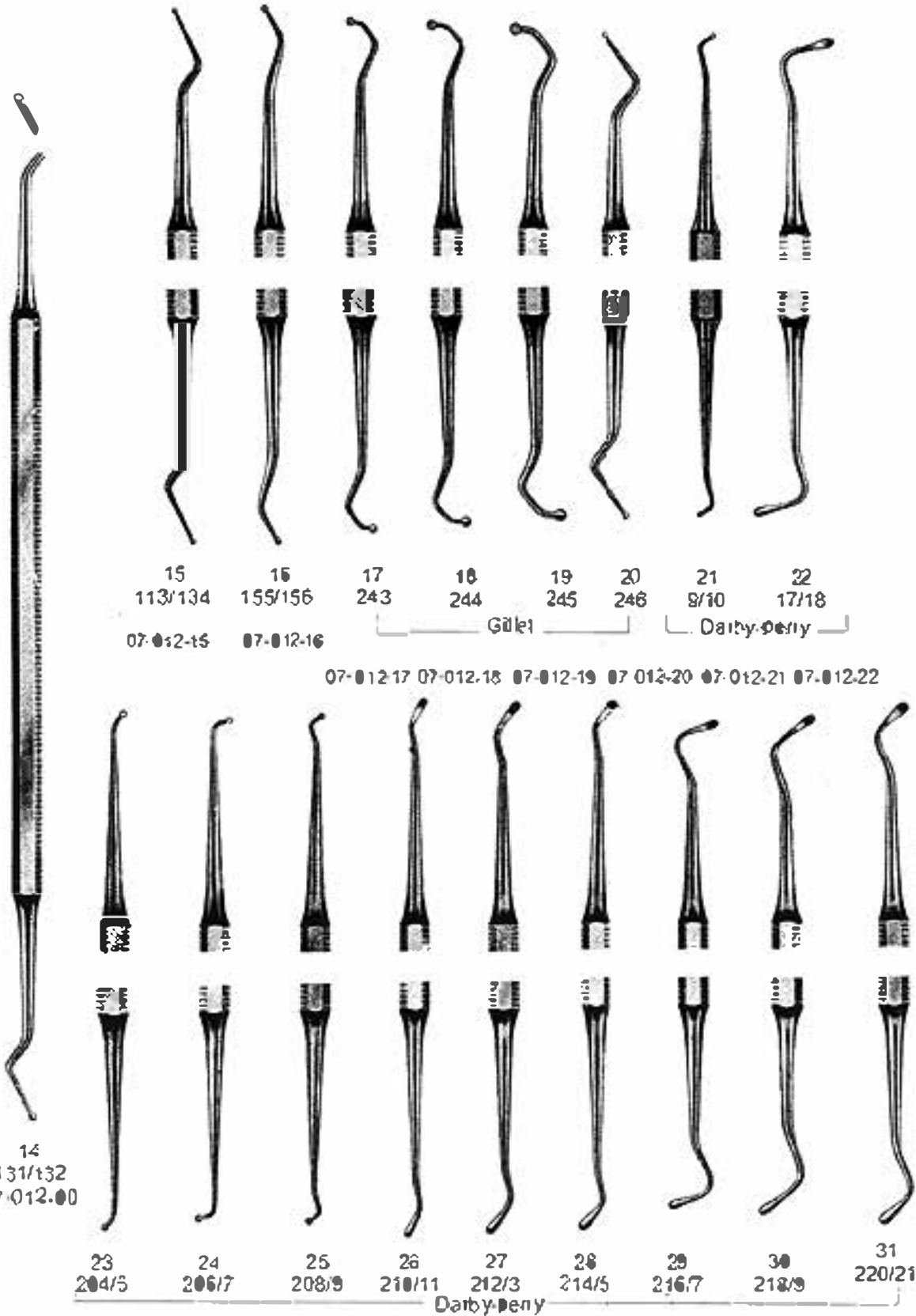

15 113/134 07-012-15  
 16 155/156 07-012-16  
 17 243  
 18 244  
 19 245  
 20 246  
 21 8/10  
 22 17/18  
 Gilet  
 Darby-Denny

07-012-17 07-012-18 07-012-19 07-012-20 07-012-21 07-012-22

14  
131/t32  
07-012-00

23 204/5  
 24 206/7  
 25 208/9  
 26 210/11  
 27 212/3  
 28 214/5  
 29 216/7  
 30 218/9  
 31 220/21  
 Darby-Denny

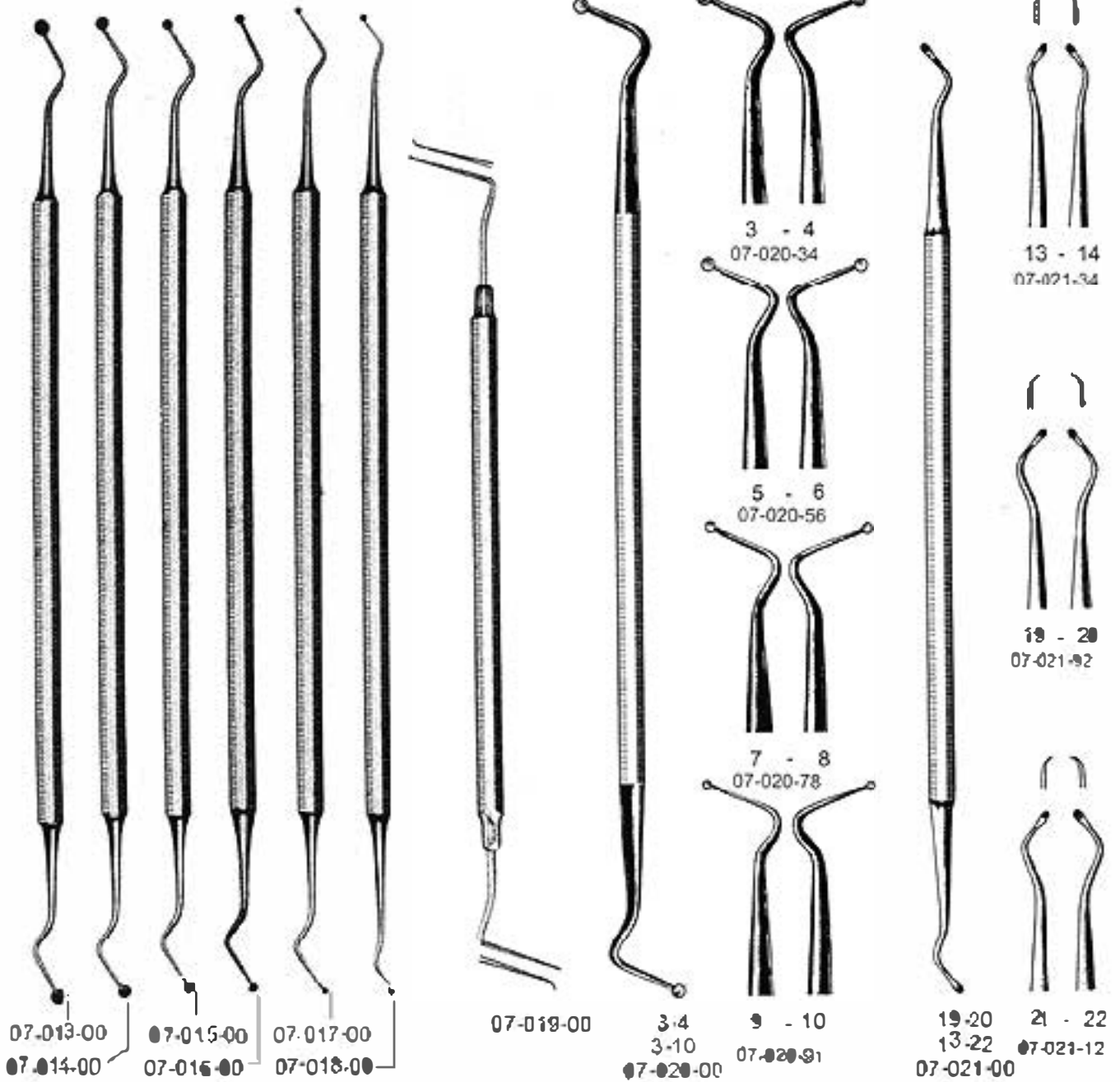

EXCAVATORS  
EXCAVATOREN  
EXCAVADORES

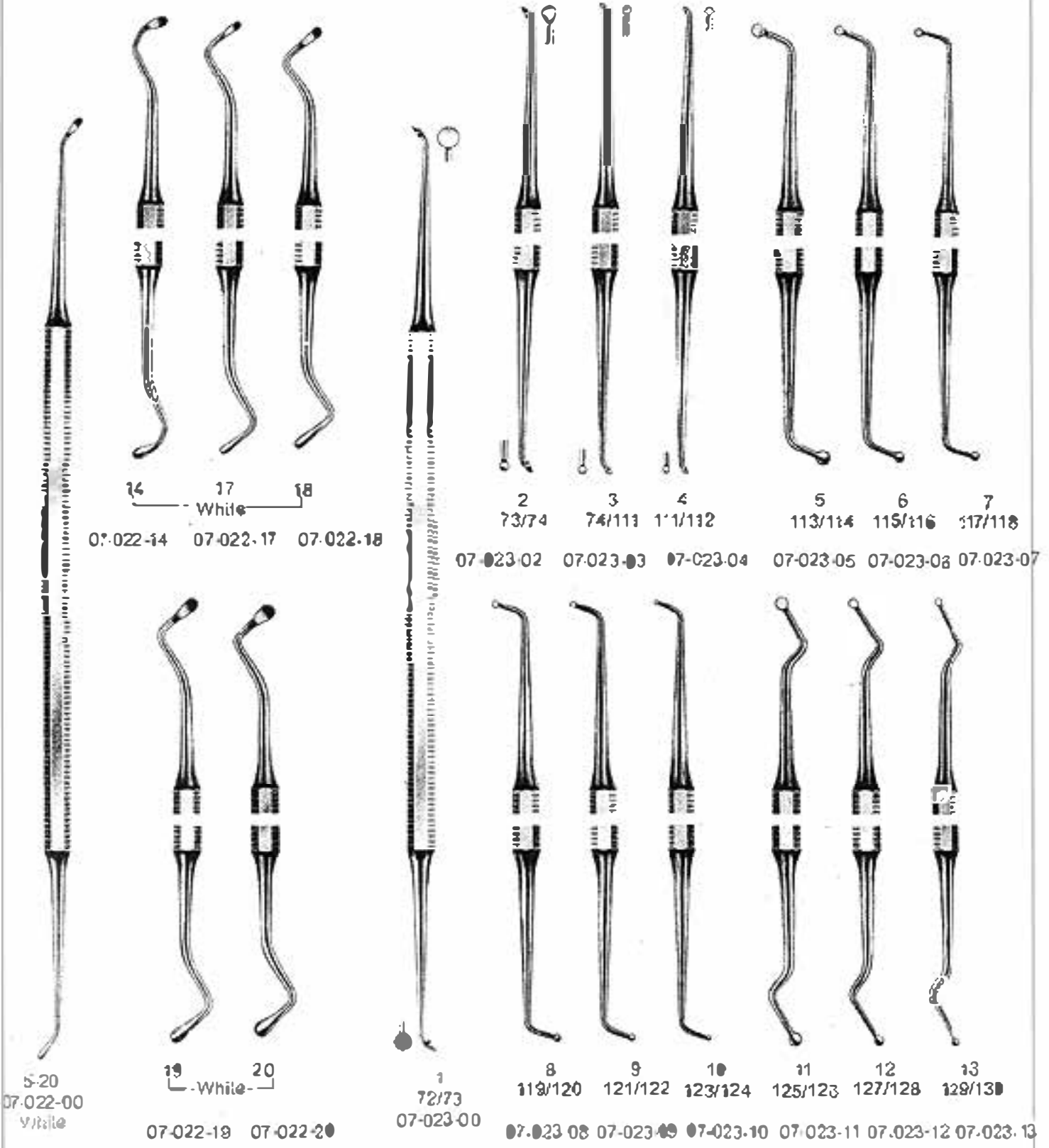
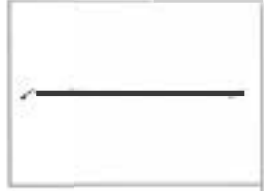

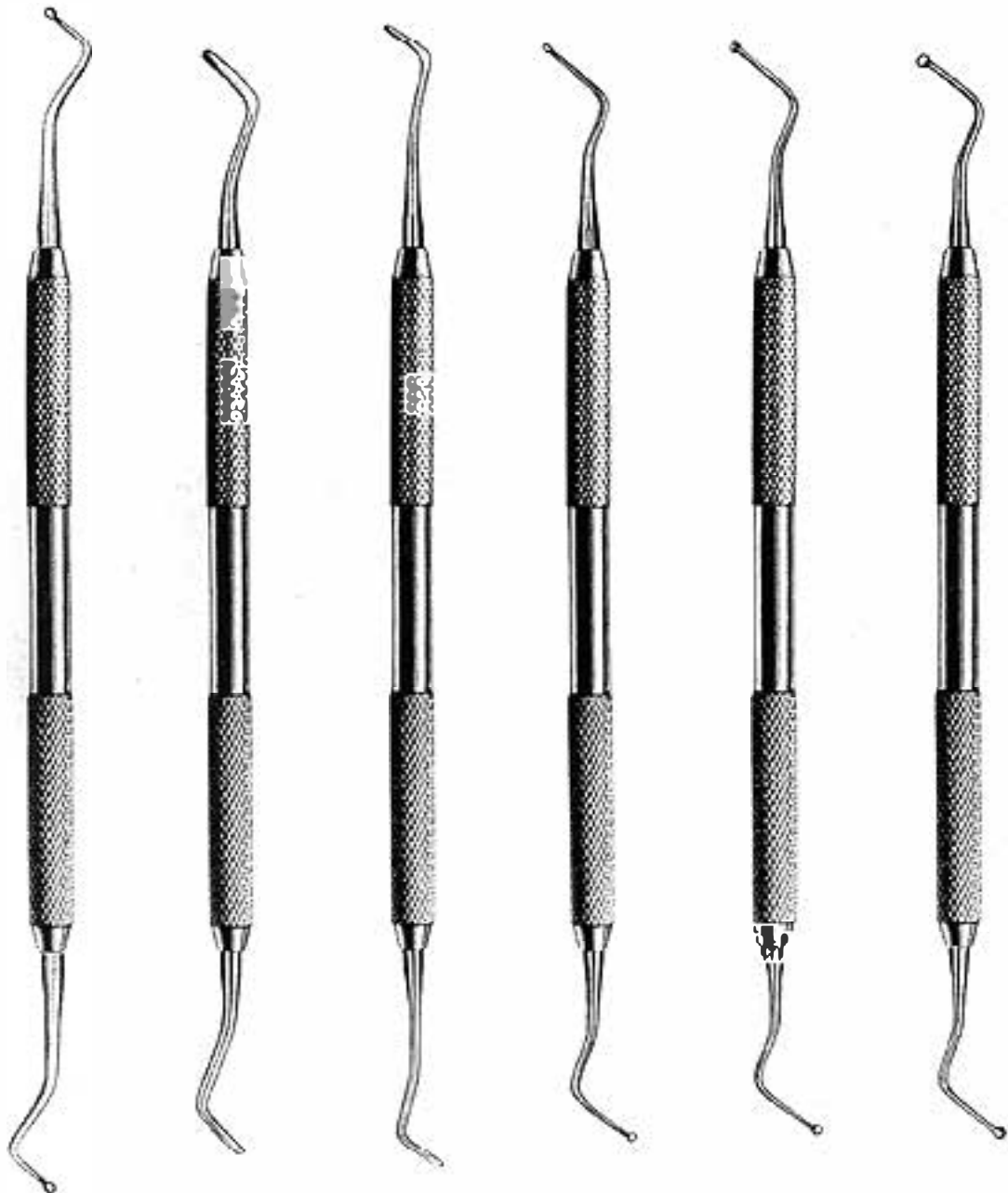

39  
Fig.38/39  
07-024-00

64  
Fig.63/64  
07-025-00

66  
Fig.65/66  
07-026-00

31L  
07-027-00

32L  
07-028-00

38L  
07-029-00

EXCAVATORS  
EXCAVATOREN  
EXCAVADORES

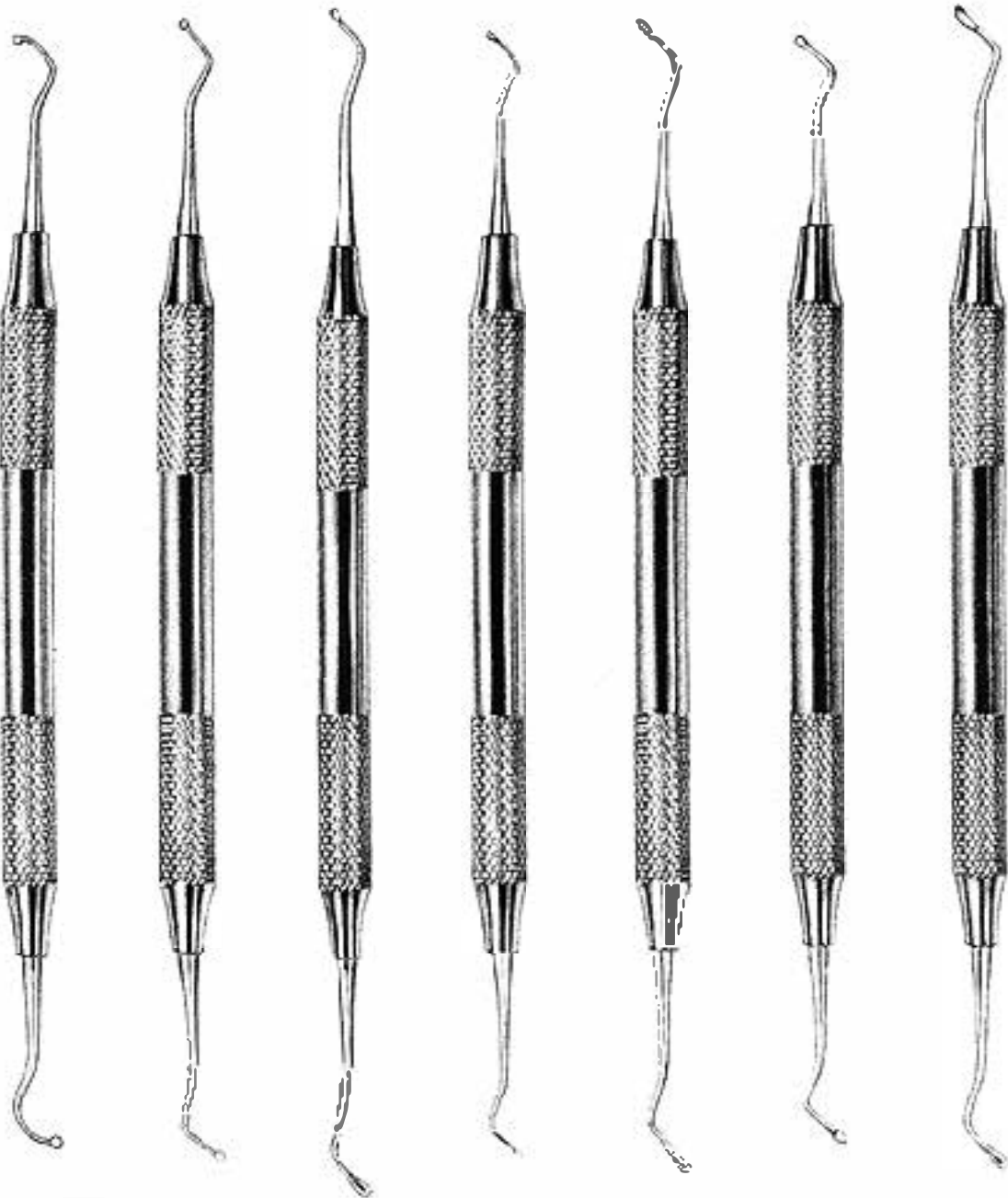

14  
07-030-00

17  
07-031-00

17W  
07-032-00  
Oval Spoon

18  
07-033-00

18W  
07-034-00  
Oval Spoon

19  
07-035-00

19W  
07-036-00  
Oval Spoon

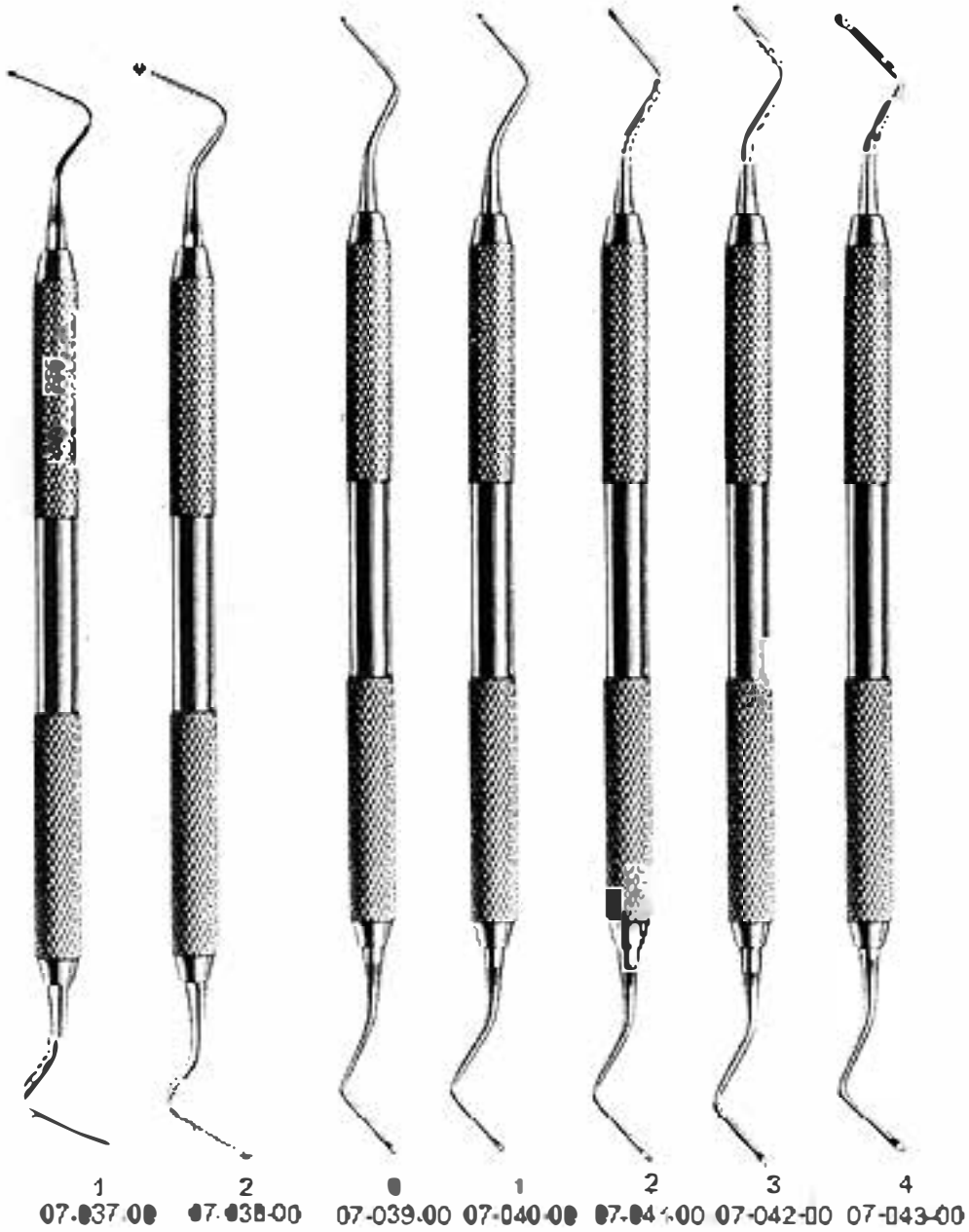

Department

08

PROBES AND EXPLORERS  
SONDES ET EXPLORATEURS  
SONDAS Y EXPLORADORES

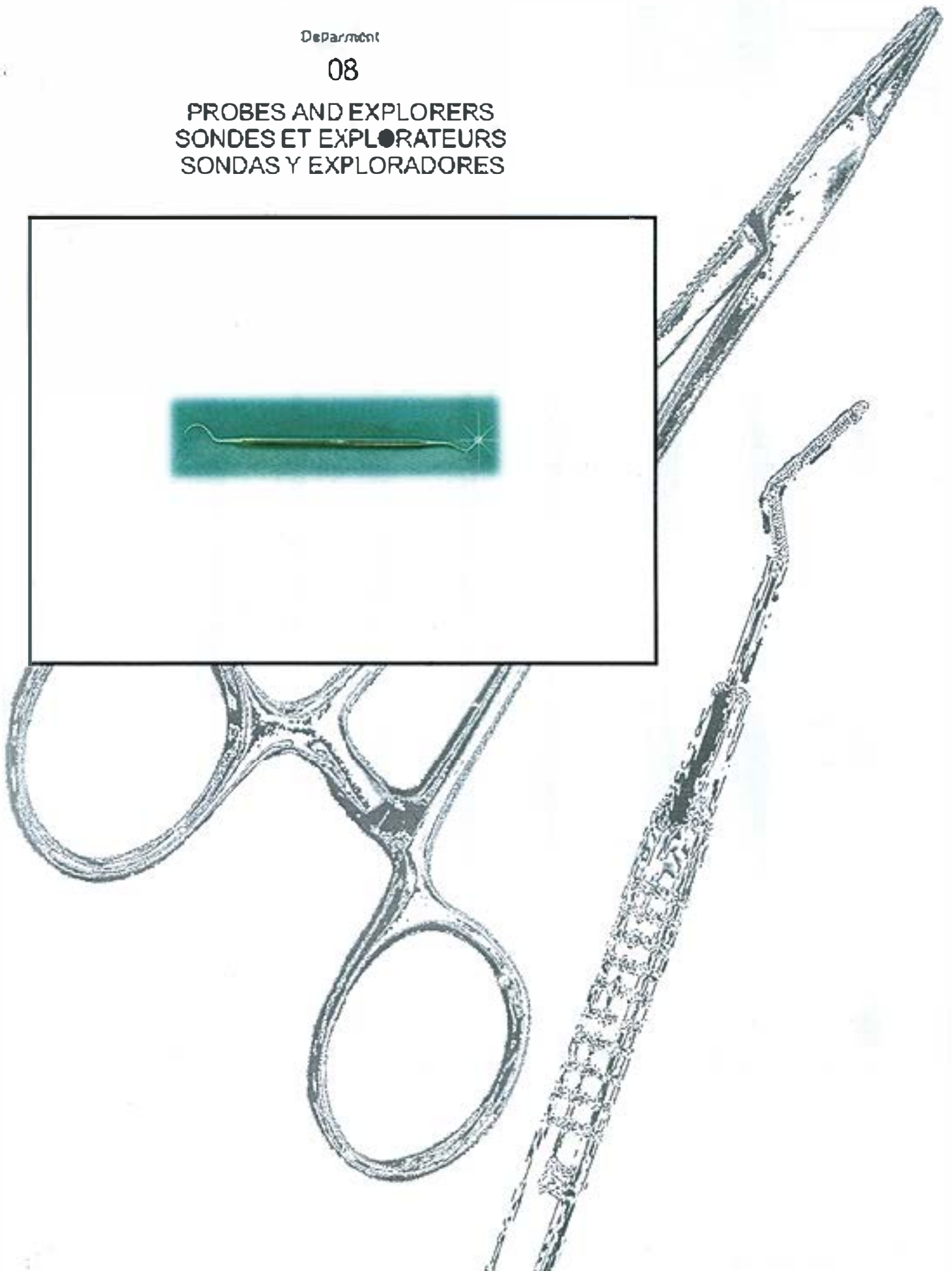
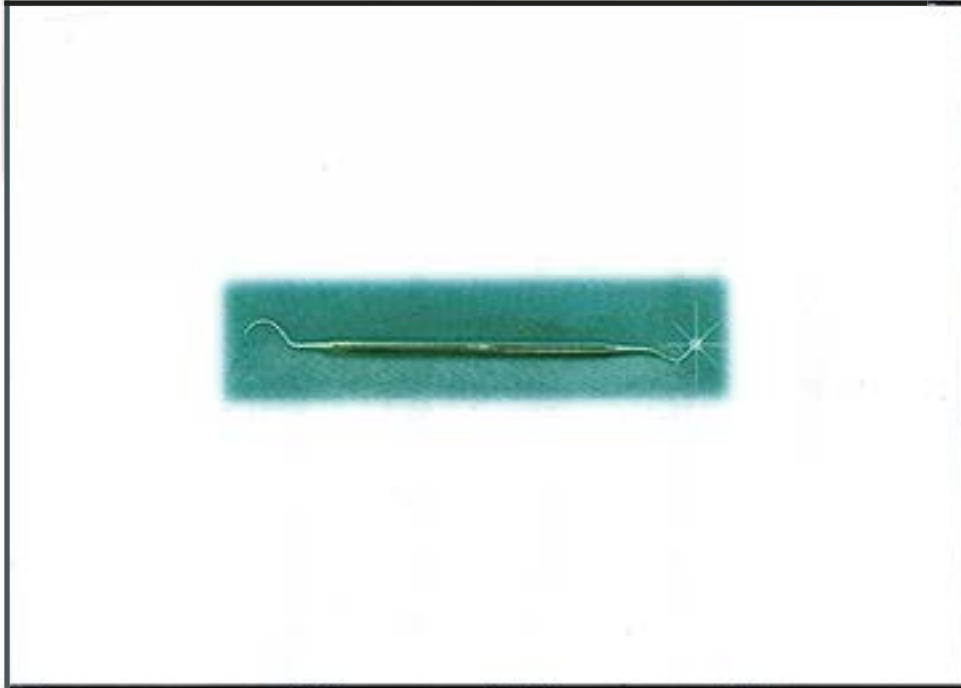

DEPARTMENT NO. 8

---

FROM  
PAGE#

144

TO  
PAGE#

150

INSTRUMENTS CATEGORY

PROBES AND EXPLORERS  
SONDES ET EXPLORATEURS  
SONDAS Y EXPLORADORES



PROBES AND EXPLORERS  
SONDES ET EXPLORATEURS  
SONDAS Y EXPLORADORES

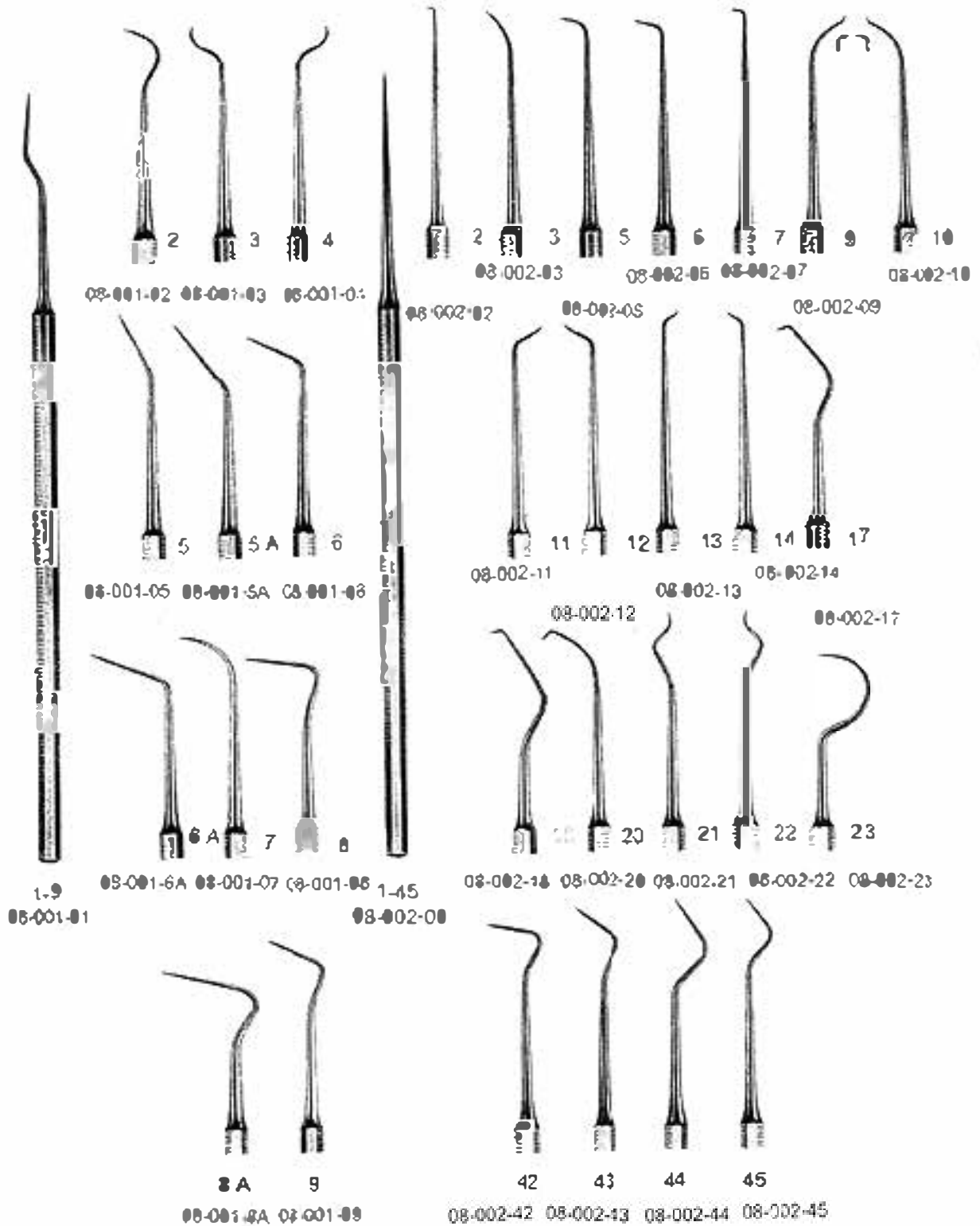

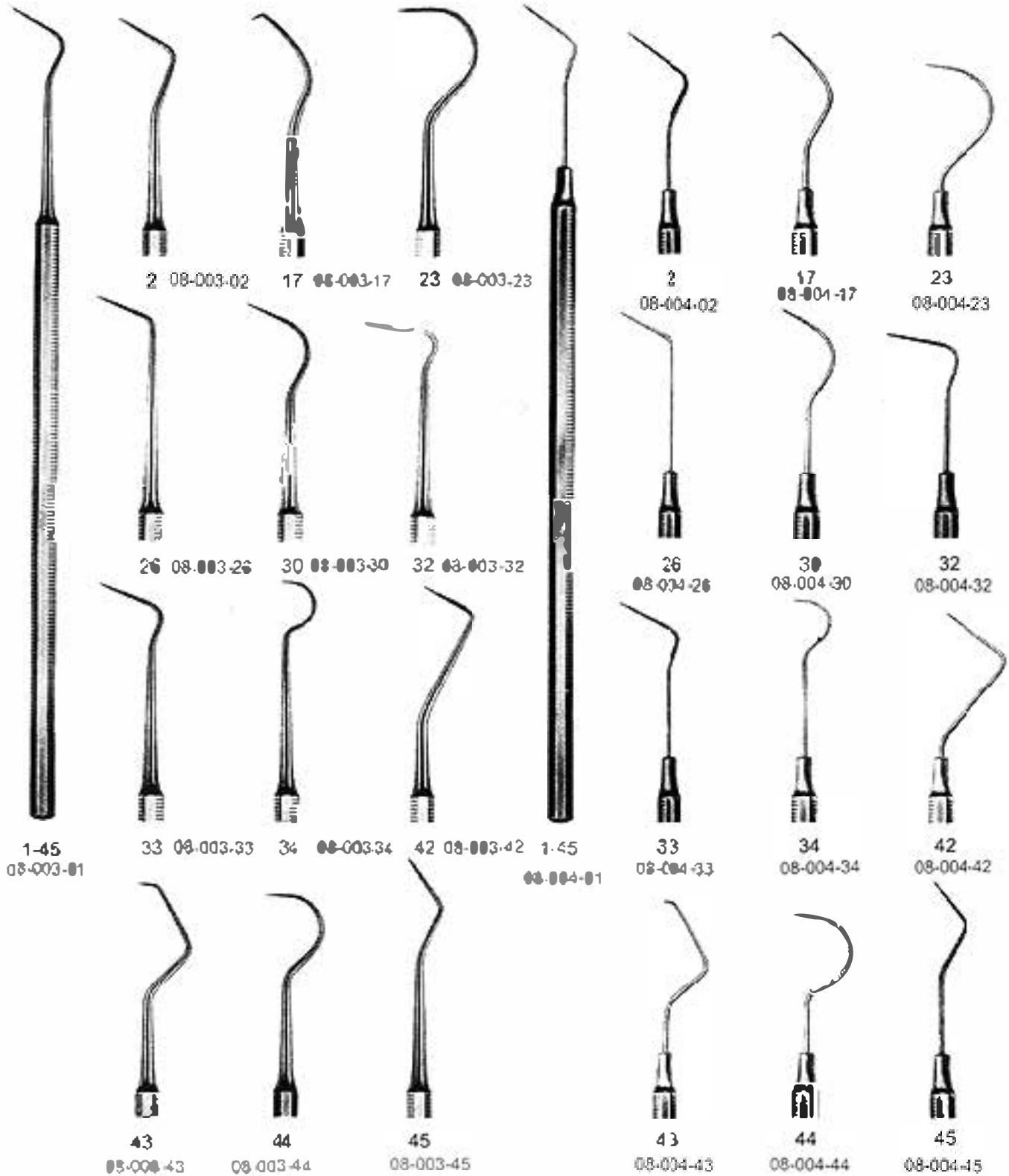

# EXPLORERS ZAHNSONDEN SONDAS

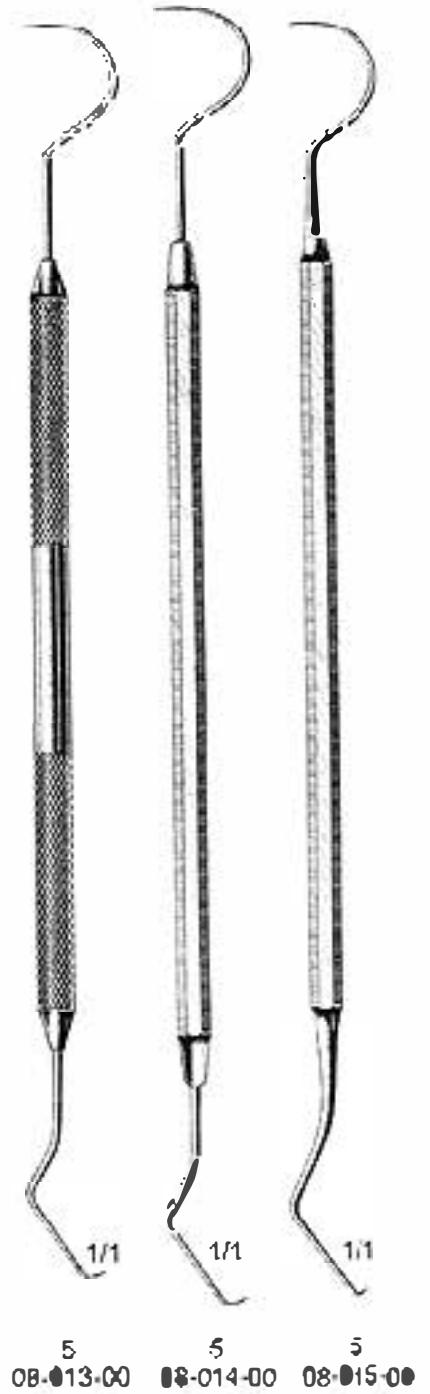
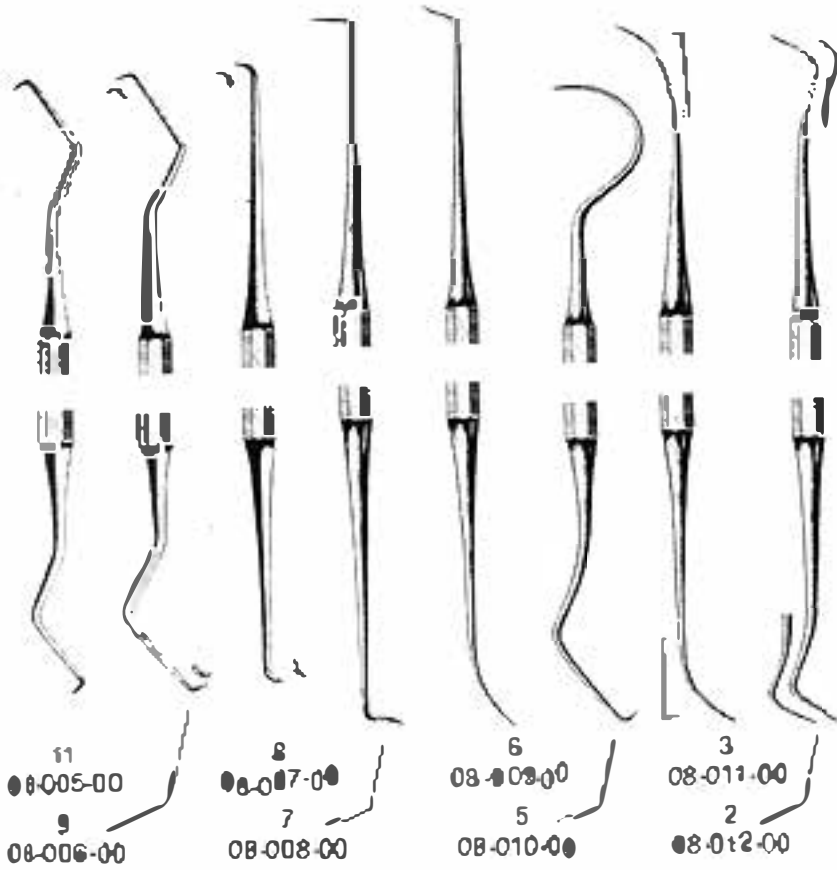

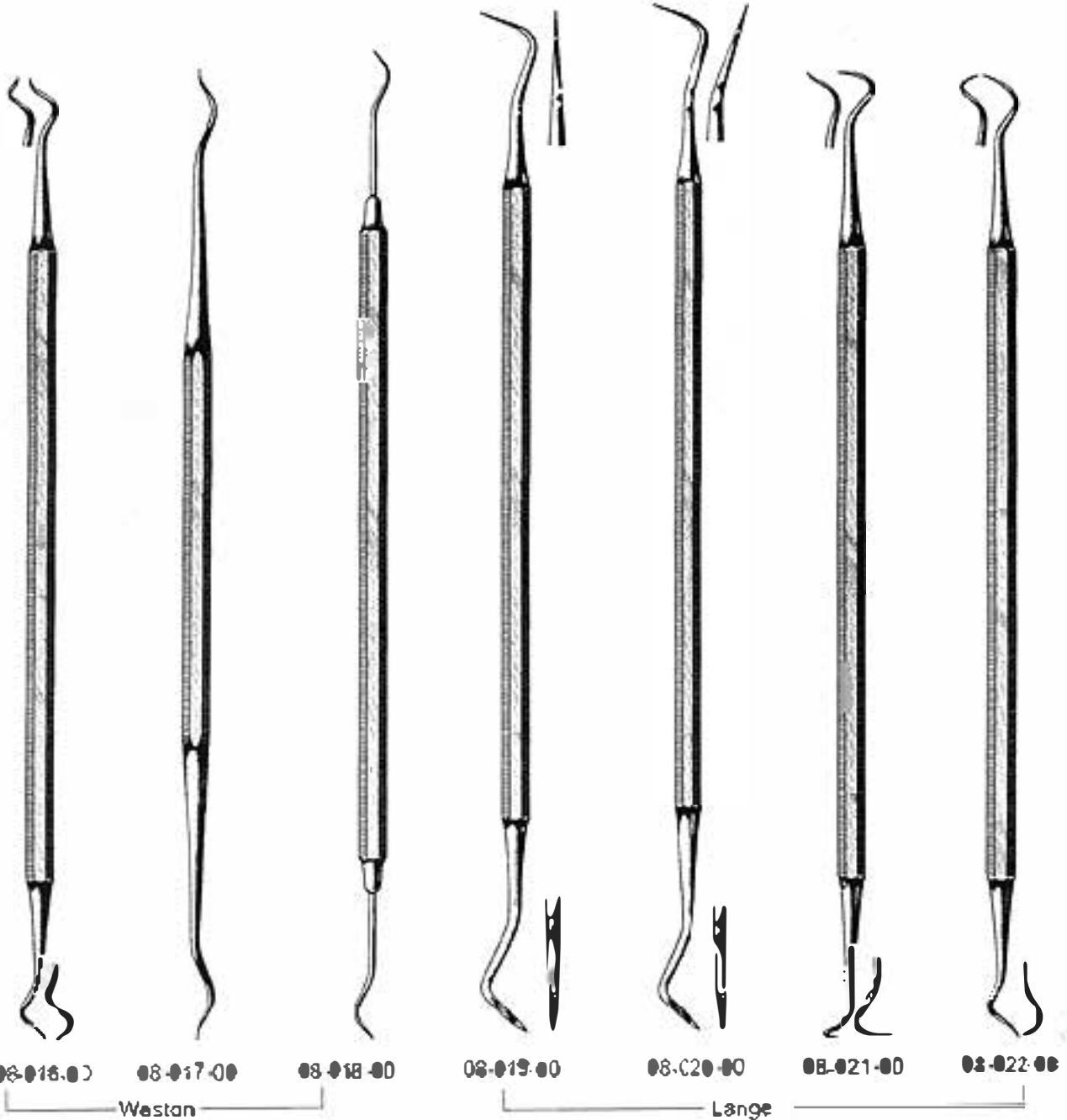

# EXPLORERS ZAHNSONDEN SONDAS

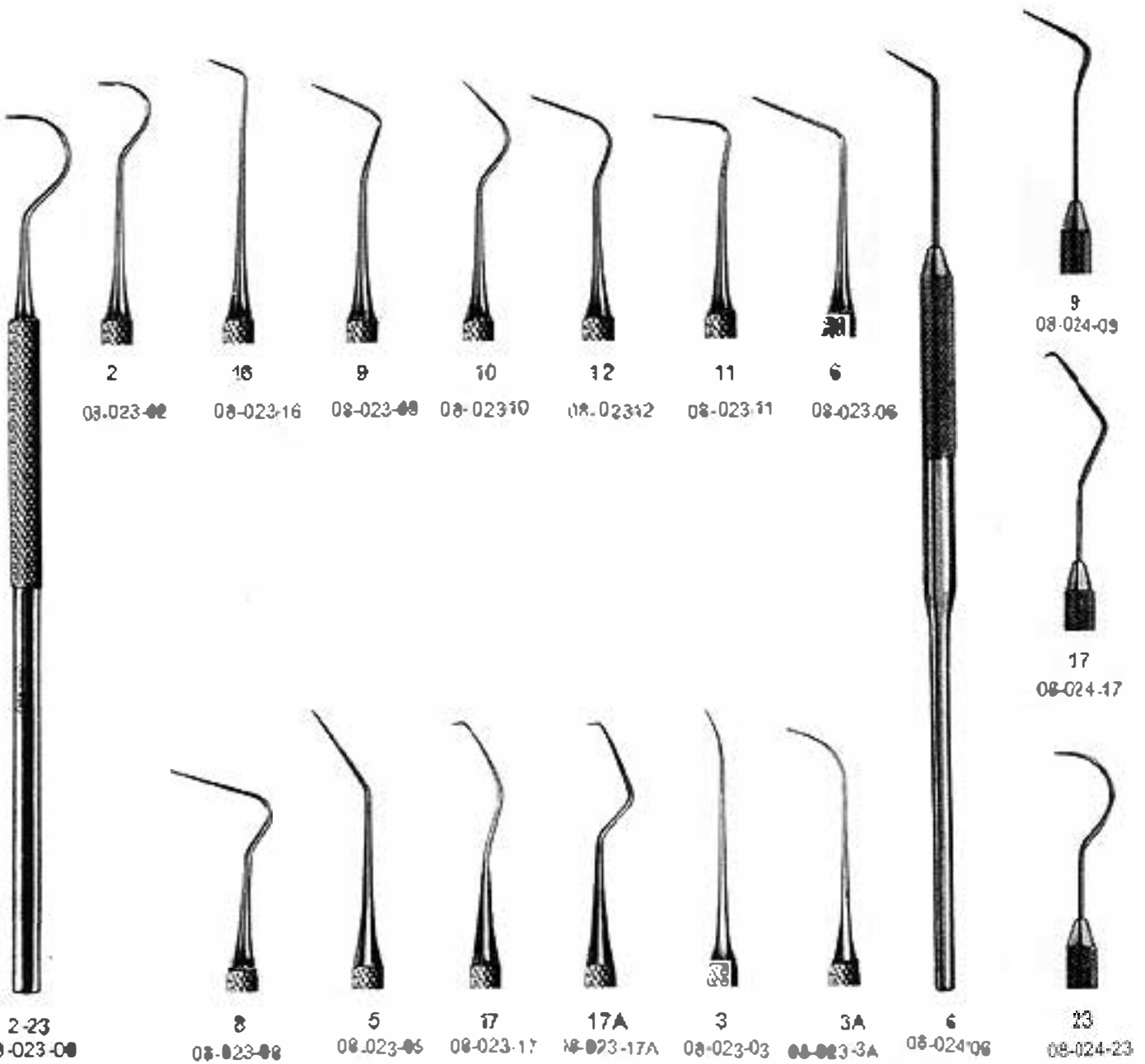

Department

09

ENDODONTIC AND NERVE INSTRUMENTS  
INSTRUMENTS A NERFS  
NERVINSTRUMENTE

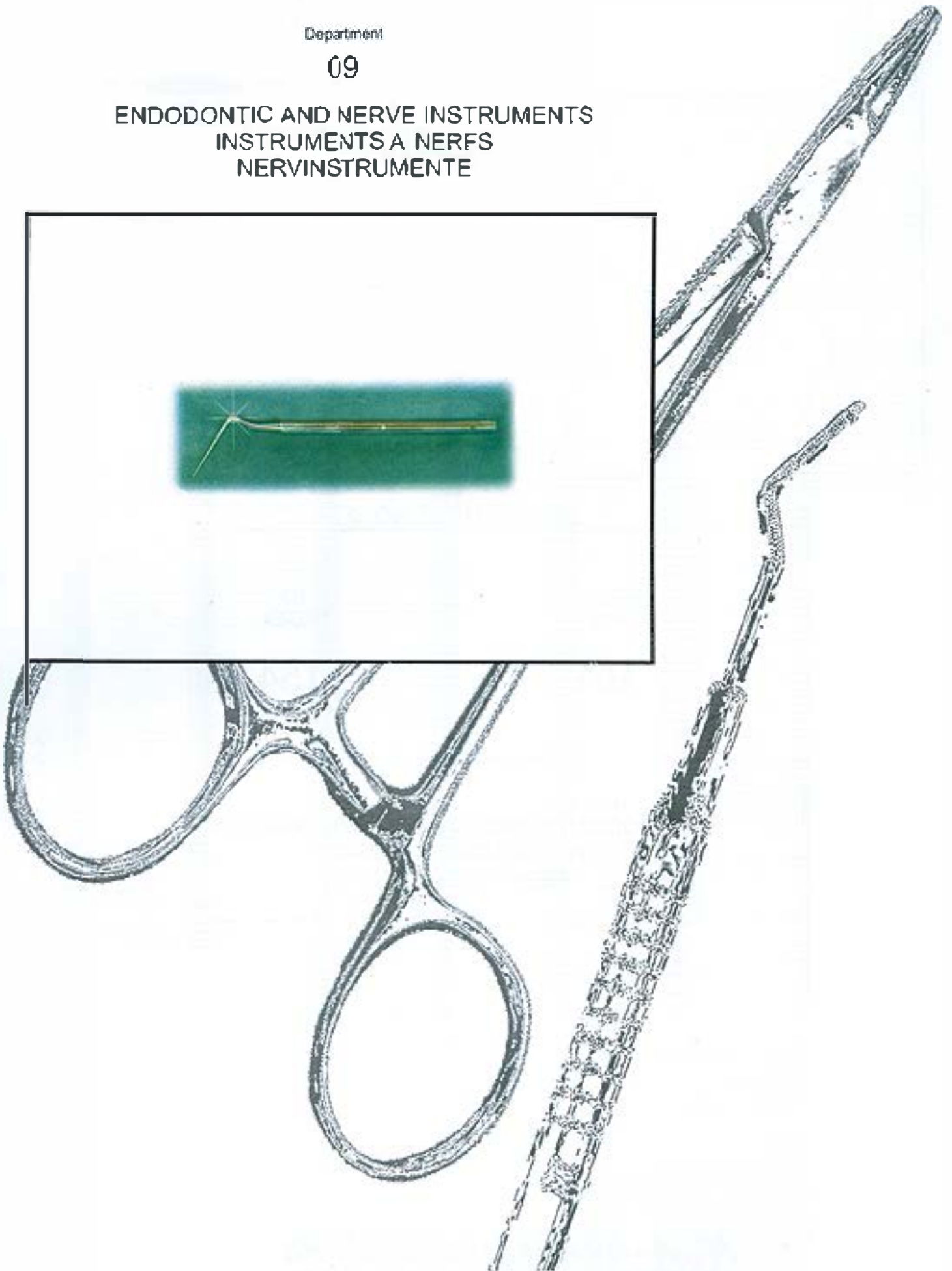
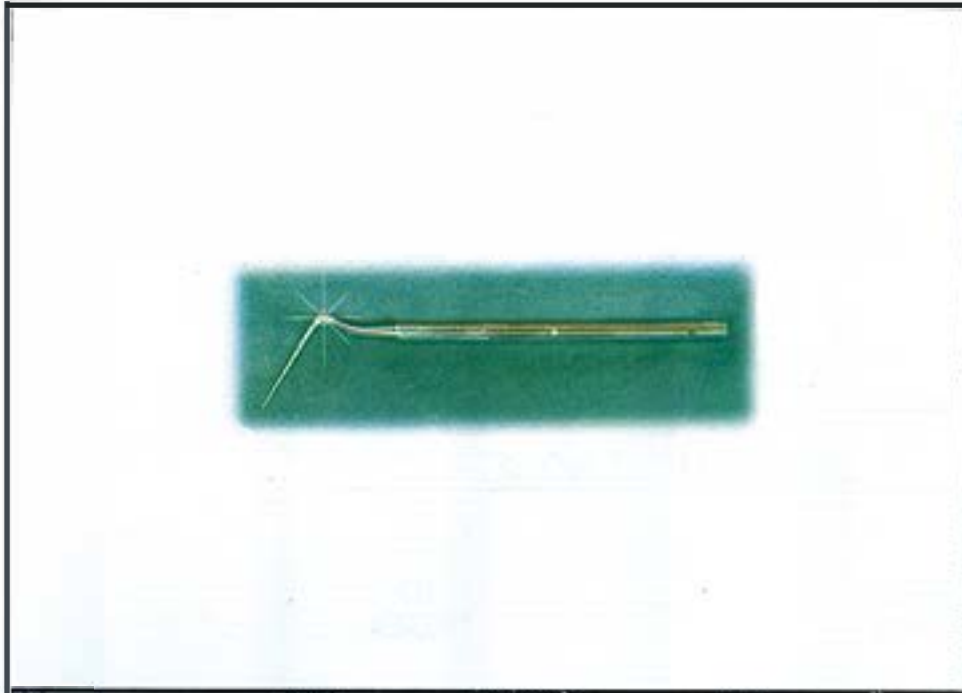

**DEPARTMENT NO. 9**

---

**FROM  
PAGE#**

**151**

**TO  
PAGE#**

**154**

**INSTRUMENTS CATEGORY**

**ENDODONTIC AND NERVE INSTRUMENTS  
INSTRUMENTS A NERFS  
NERVINSTRUMENTE**

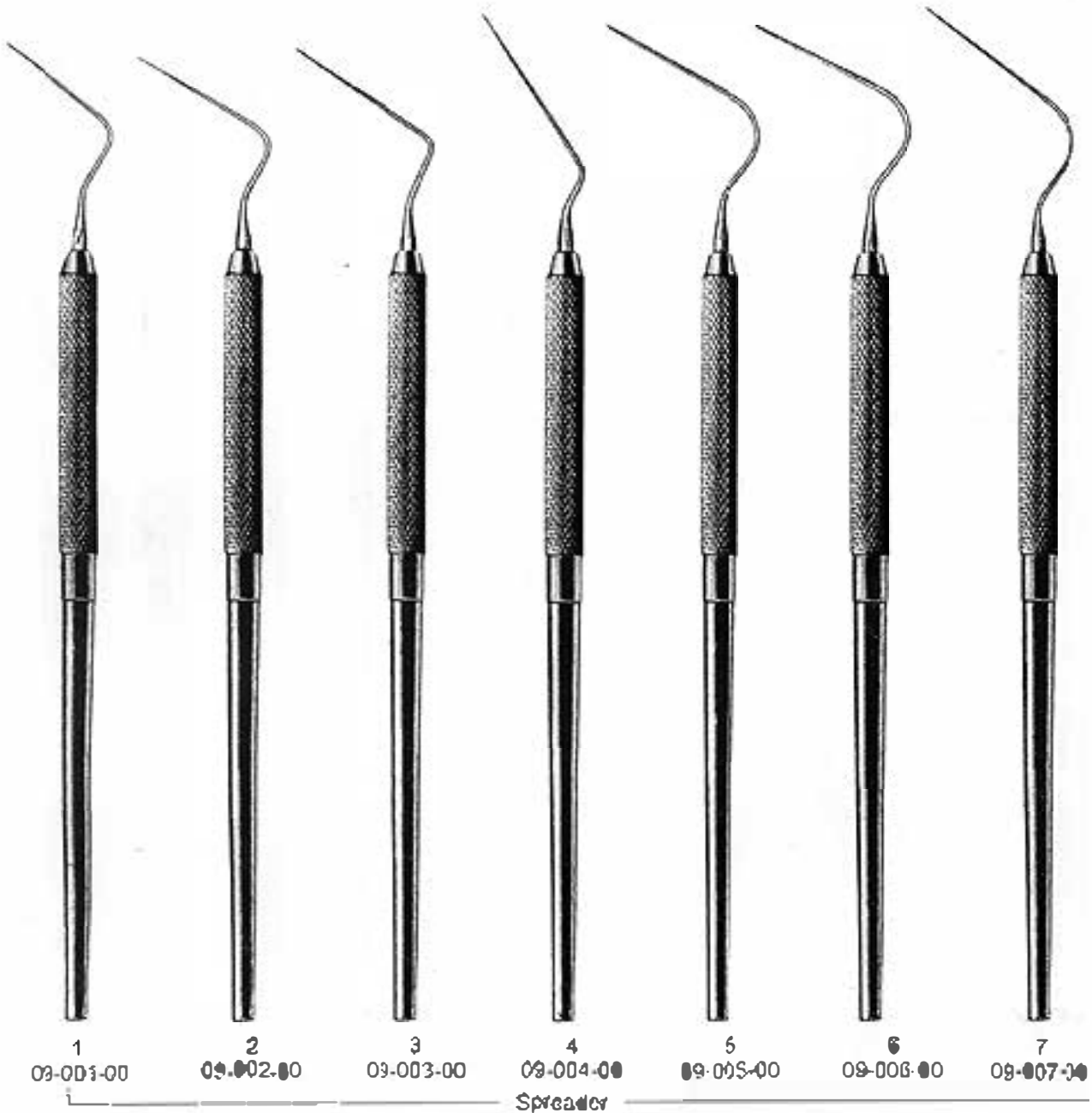



# ENDODONTIC AND NERVE INSTRUMENTS INSTRUMENTS A NERFS NERVINSTRUMENTE



1-8  
09-002-02  
Thuermergel



2



3



4



5



6

Thuermergel

09-002-02 09-003-03 09-004-04 09-005-05 09-006-06



2/3



1  
09-009-15  
15 cm



2/3



2  
09-010-15  
15 cm

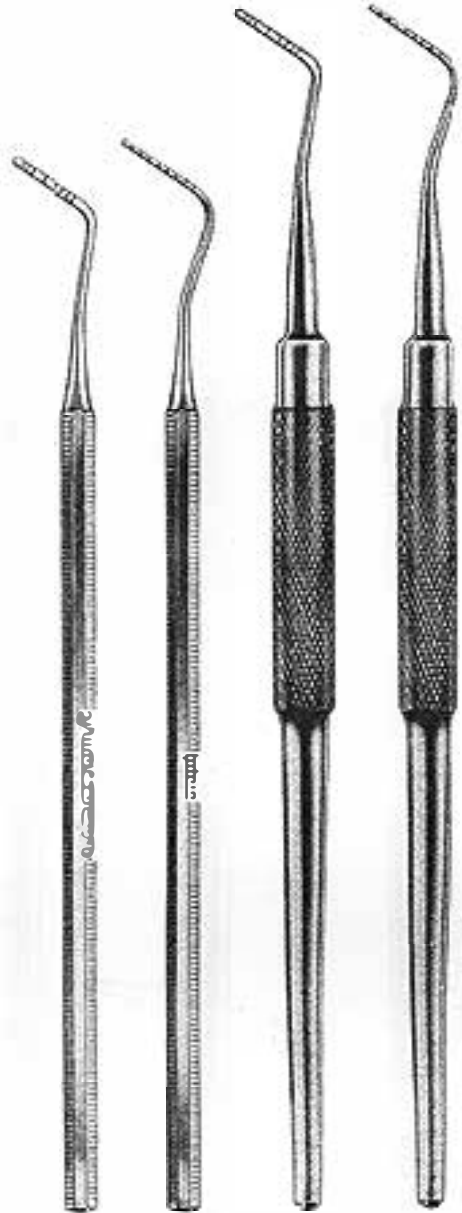

1 2 1 2  
09-011-00 09-012-00 09-013-00 09-014-00  
Williams



Williams  
 09-015-00



Goldman-Fox  
 09-016-00



Goldman-Fox  
 Williams  
 09-017-00



Goldman-Fox  
 Williams  
 09-018-00

PERIODONTAL POCKET PROBES  
PARODONTOMETER  
SONDAS CALIBRADAS



Off Set  
Williams De  
09-019-00



Nabers  
09-020-00



23/W  
Williams  
09-021-00



09-022-00



09-030-01

09-031-02

09-032-03

09-033-04

Explorer  
23  
09-045-23

155 B

Department

10

CEMENT SPATULAS  
SPATULES A CIMENT  
ESPATULAS PARA CEMENTO

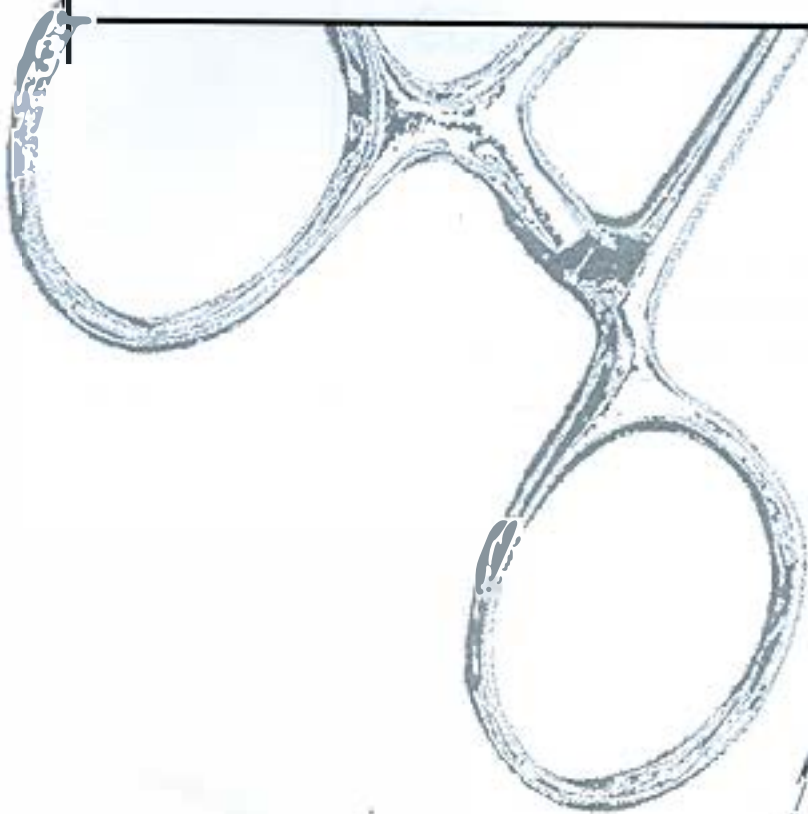
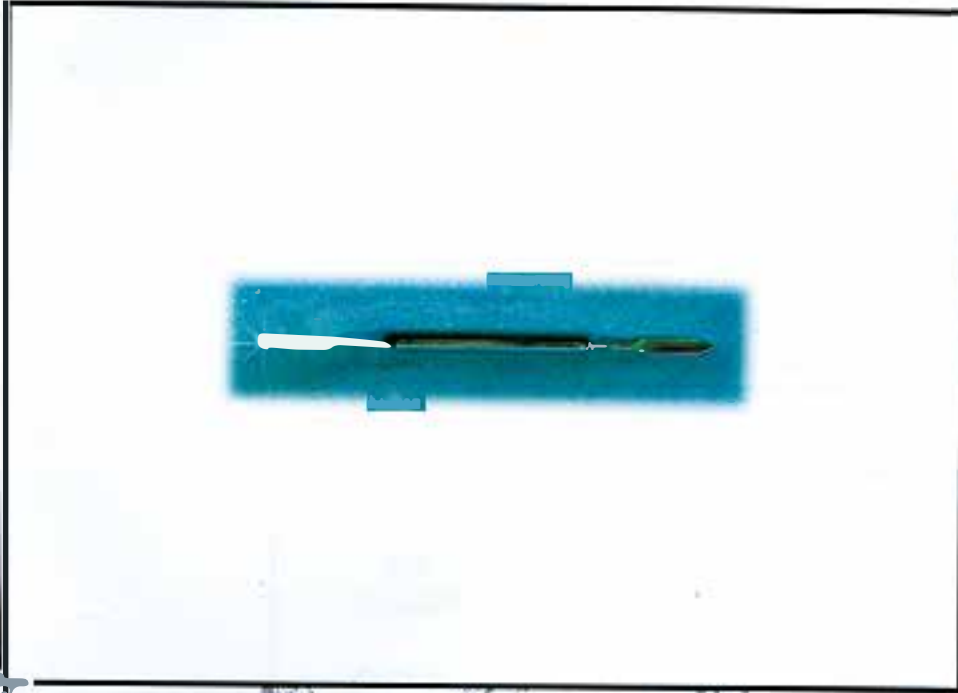

BASIC SET  
GRUNDLEGENDER SATZ  
EL CONJUNTO BASICO



**Basic Set in Pouch Consisting of Following Instruments**

Mirror No. 5 with handle

Excavator No. 17

Explorer No. 5

College Tweezer Serrated 15 cm

09-051-00

155 C

DEPARTMENT NO. 10

FROM  
PAGE#

155

TO  
PAGE#

159

INSTRUMENTS CATEGORY

CEMENT SPATULAS  
SPATULES A CIMENT  
ESPATULAS PARA CEMENTO

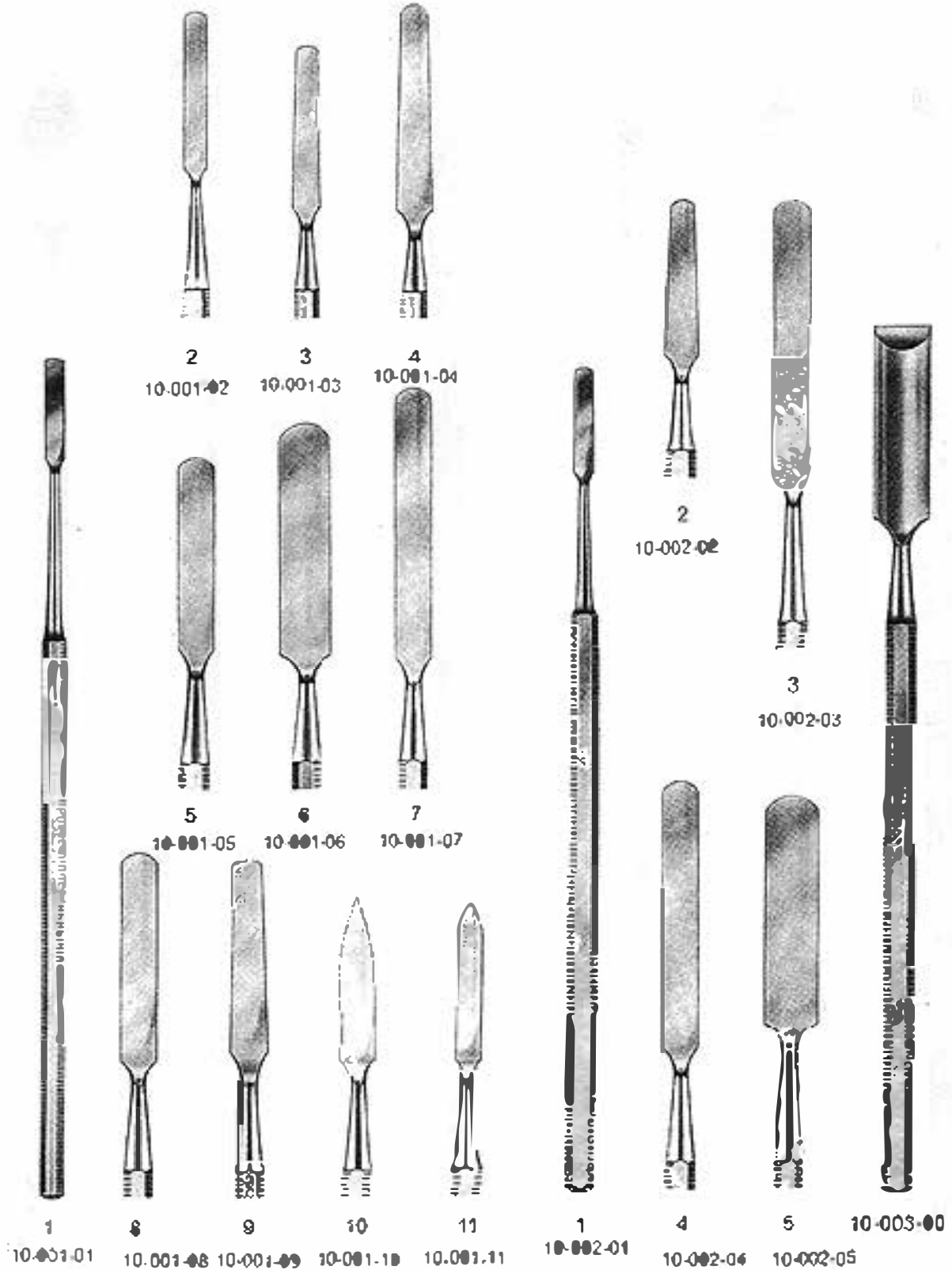
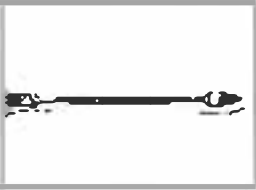



CEMENT SPATULAS  
 SPATULES A CIMENT  
 ESPATULAS PARA CEMENTO



10 004 03



10-004-05



10-005-00



10-005-00



10 007 00



Gntman 31  
 10 008 00

10 004 01

10-007-04

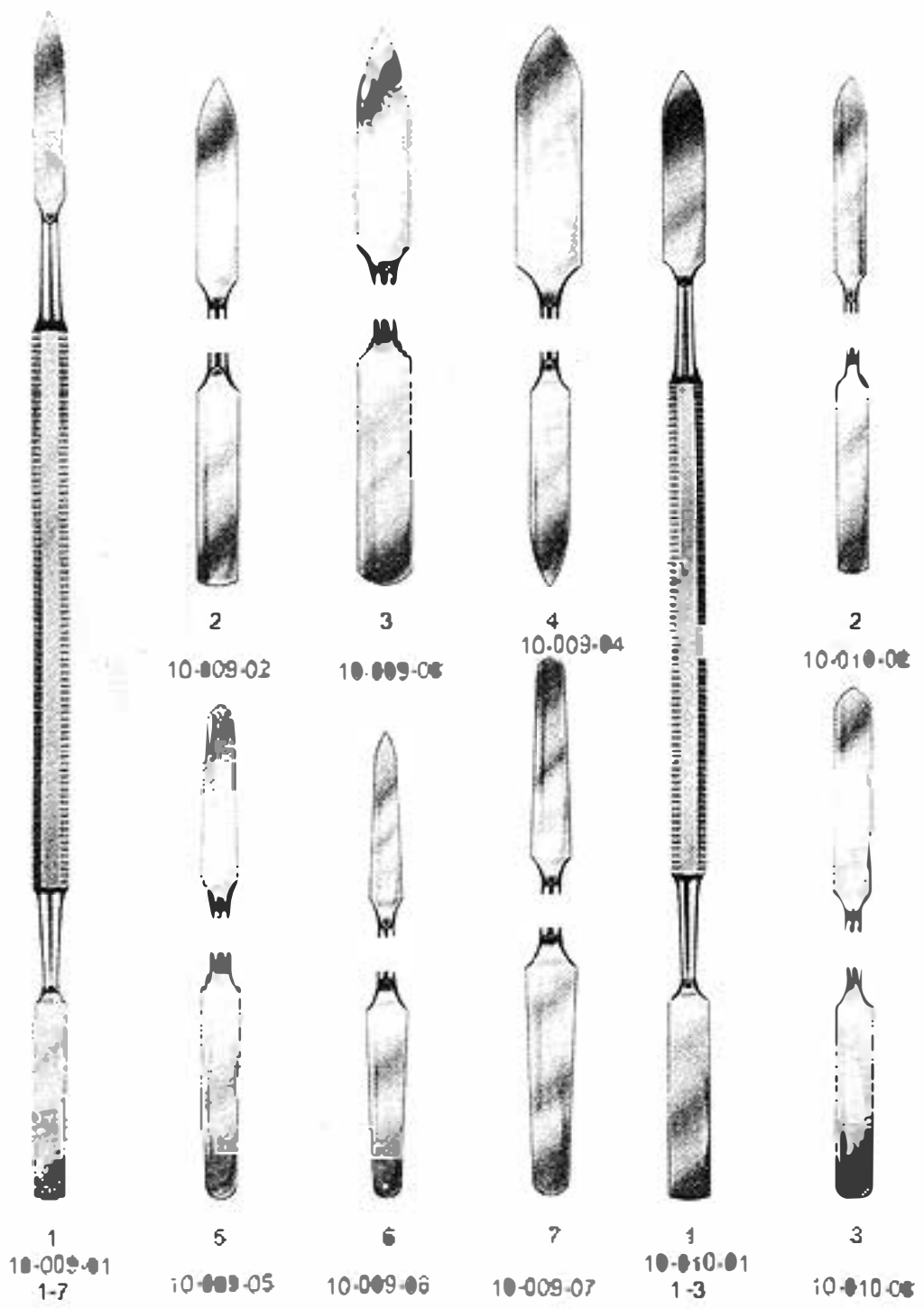

Department

11

AMALGAM INSTRUMENTS  
AMALGAM INSTRUMENTE  
INSTRUMENTOS PARA AMALGAM

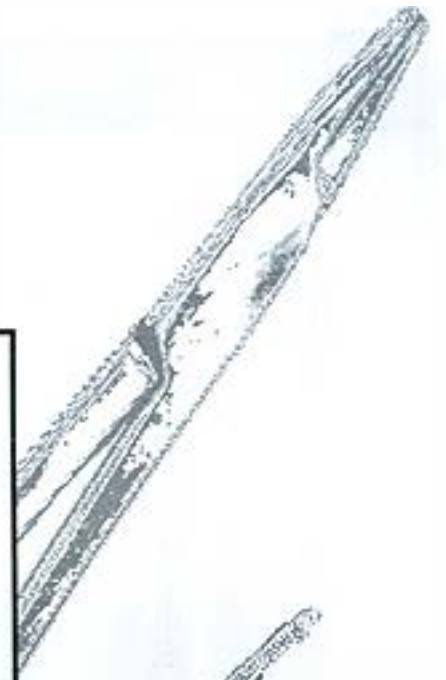
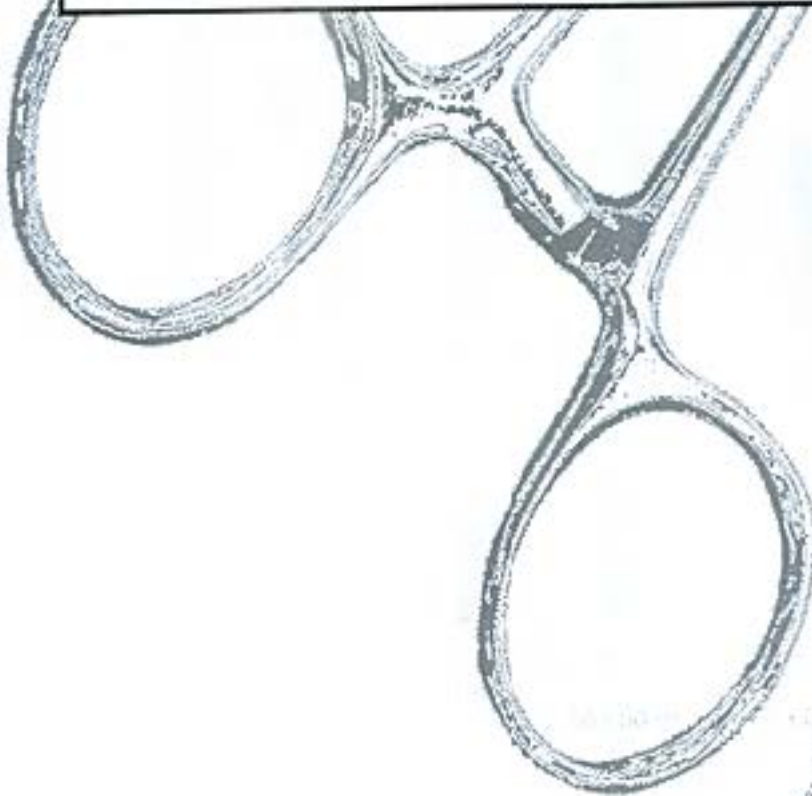
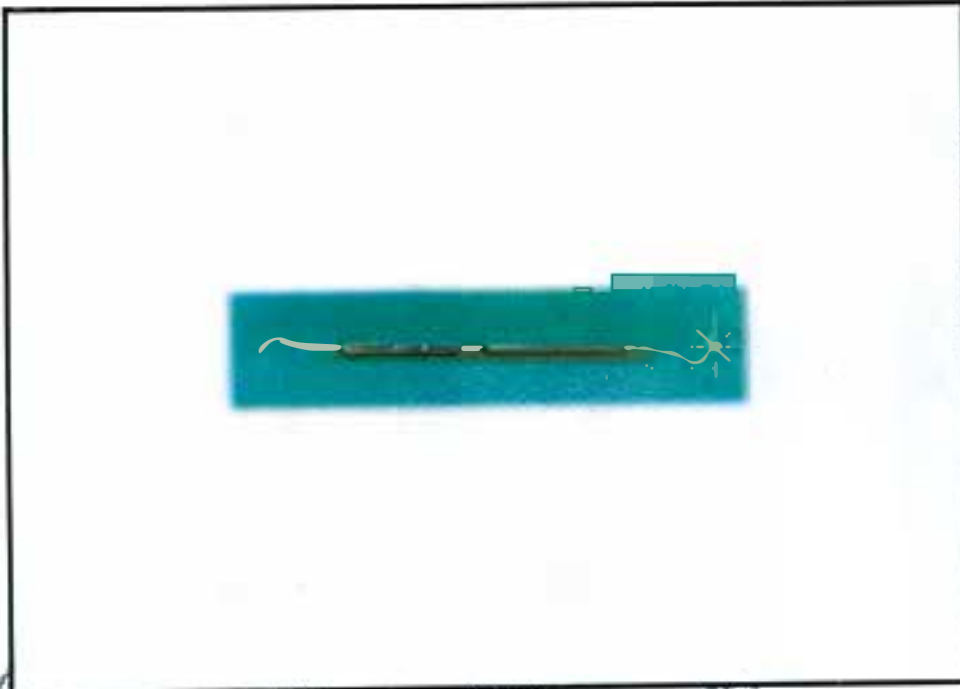

**DEPARTMENT NO. 11**

---

**FROM  
PAGE#**

**160**

**TO  
PAGE#**

**168**

**INSTRUMENTS CATEGORY**

**AMALGAM INSTRUMENTS  
AMALGAM INSTRUMENTE  
INSTRUMENTOS PARA AMALGAM**

CEMENT SPATULAS  
SPATULES A CIMENT  
ESPATULAS PARA CEMENTO

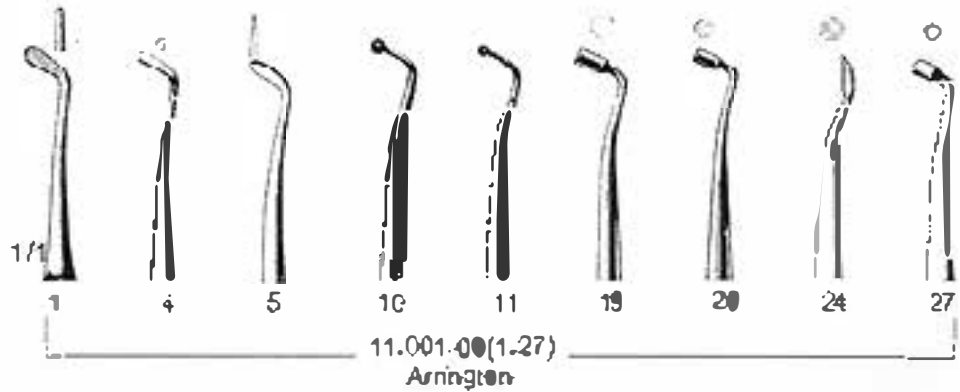
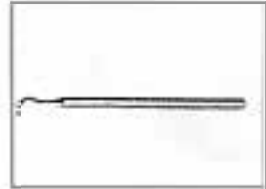

11-001-01 11-001-04 11-001-05 11-001-10 11-001-11 11-001-19 11-001-20 11-001-24 11-001-27

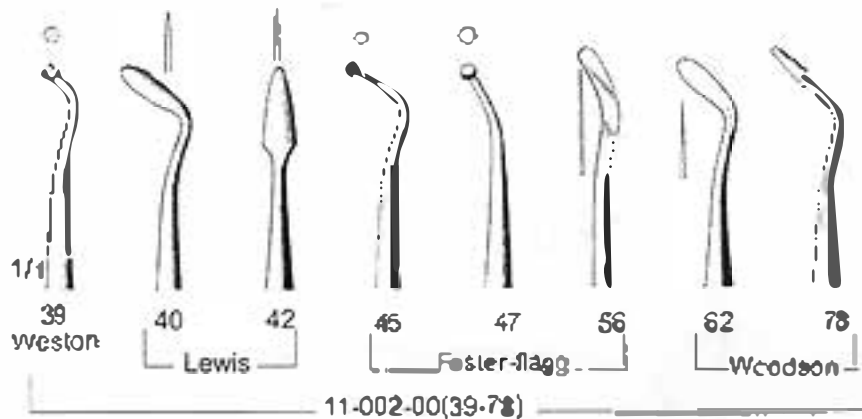

11-002-39 11-002-40 11-002-42 11-002-45 11-002-47 11-002-56 11-002-62 11-002-78

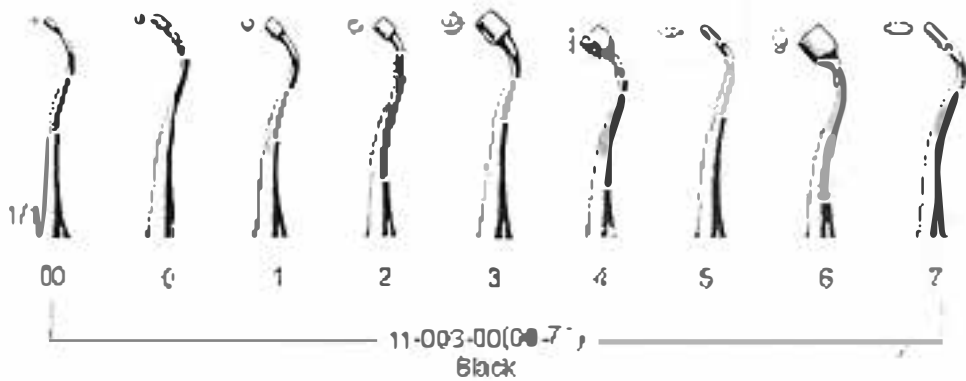

11-003-40 11-003-20 11-003-01 11-003-02 11-003-03 11-003-04 11-003-05 11-003-06 11-003-07

1  
11-001-00(1-27)  
11-002-00(39-78)  
11-003-00(00-7)

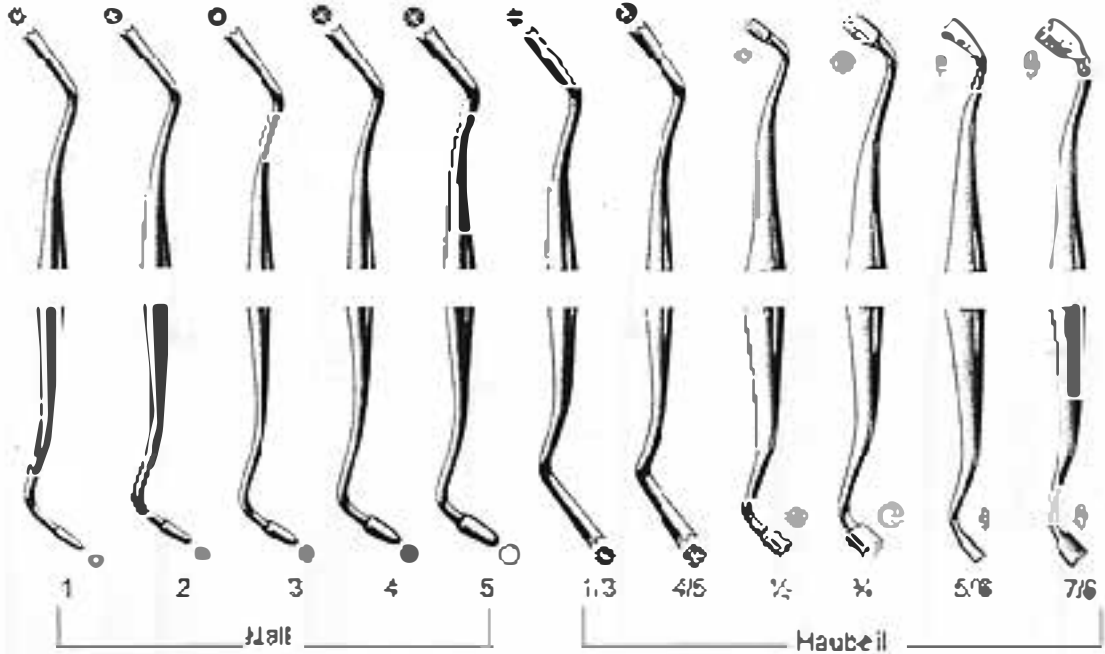

1 2 3 4 5 1.3 4/5 1/2 3/4 5/6 7/8

Haubeil

11-004-00(1-7/8)

11-004-01 11-004-02 11-004-03 11-004-04 11-004-05 11-004-1/3 11-004-4/5 11-004-1/2 11-004-3/4 11-004-5/6 11-004-7/8

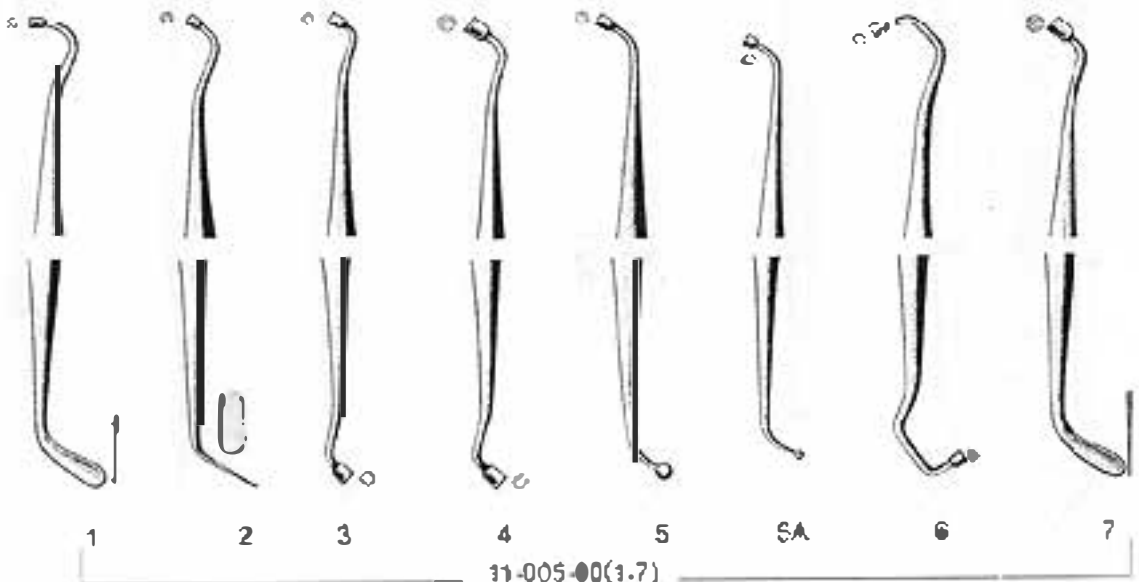

1 2 3 4 5 6A 6 7

11-005-00(1.7)  
Modell-Amalg

11-005-01 11-005-02 11-005-03 11-005-04 11-005-05 11-005-5A 11-005-06 11-005-07

11-004-00(1-7/8)  
11-005-00(1-7)

AMALGAM INSTRUMENTS  
AMALGAM INSTRUMENTE  
INSTRUMENTOS PARA AMALGAM

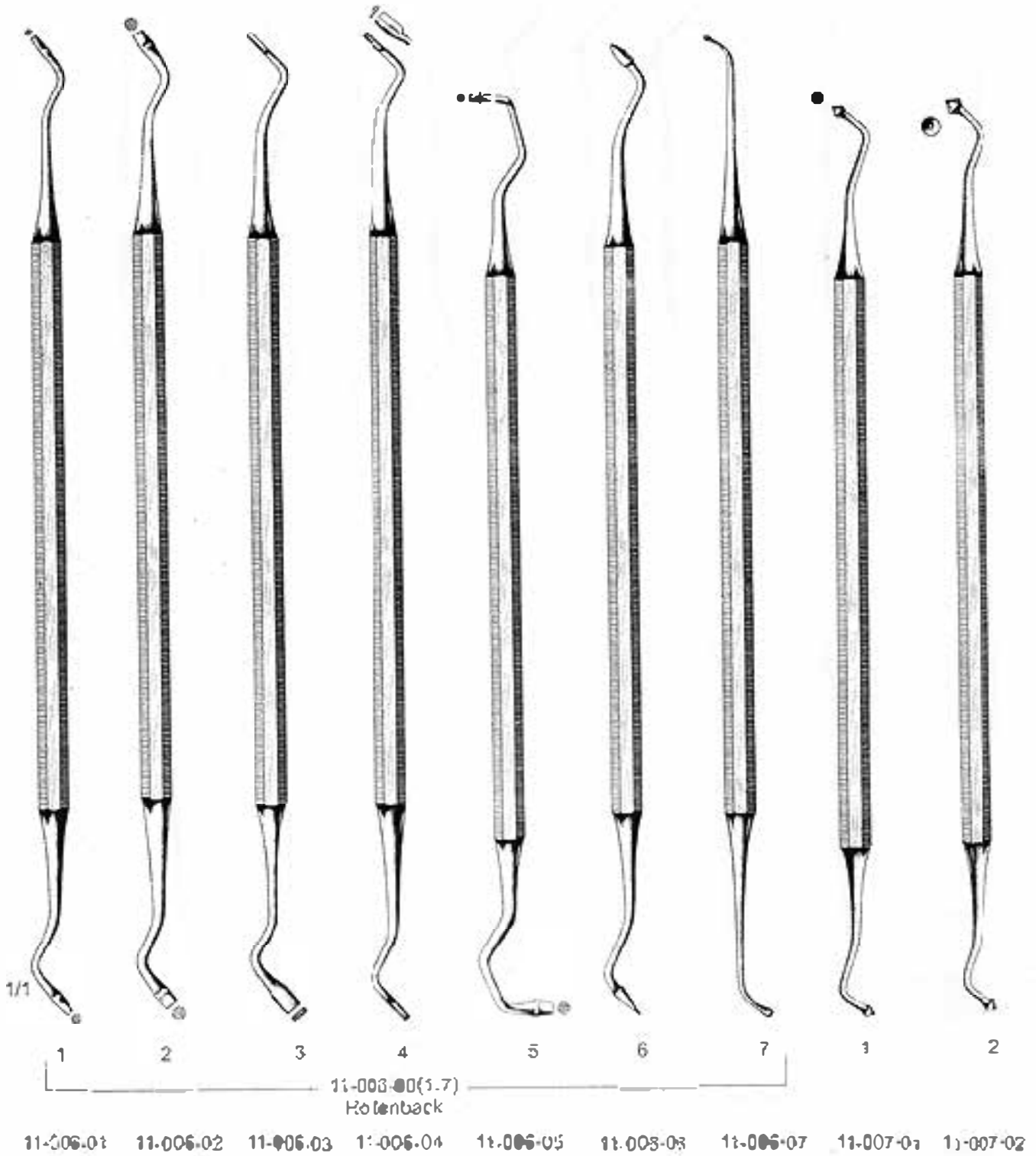



1-2

11-008-00



2-3

11-009-00



1-2

11-010-00



3-4

11-011-00



5-6

11-012-00



7-8

11-013-00

Black

Silver



AMALGAM INSTRUMENTS  
AMALGAM INSTRUMENTE  
INSTRUMENTOS PARA AMALGAM

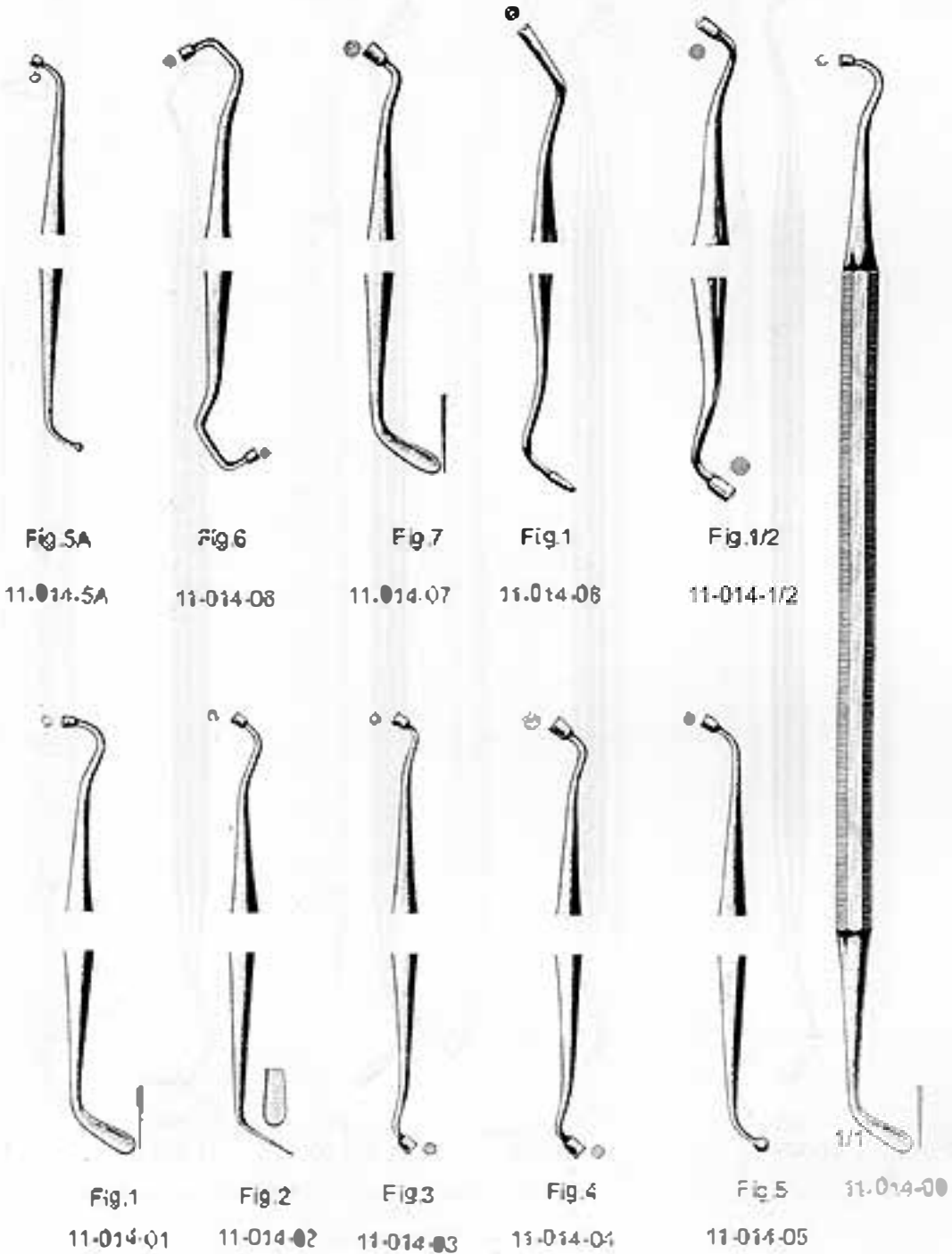
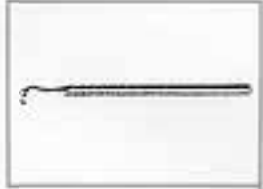



WA-4  
 11-015-00

Wallis-4



WI-4  
 11-016-00

William-4



11-017-00  
 Porcelain

Porcelain



11-018-00  
 Pela Carver

Pela Carver



11-019-00  
 Nystrom Cervical

Nystrom Cervical

AMALGAM CARVER  
INSTRUMENTE ZUM MODELLIEREN VON FÜLLUNGEN  
INSTRUMENTOS PARA MODELAR LAS OBTURACIONES

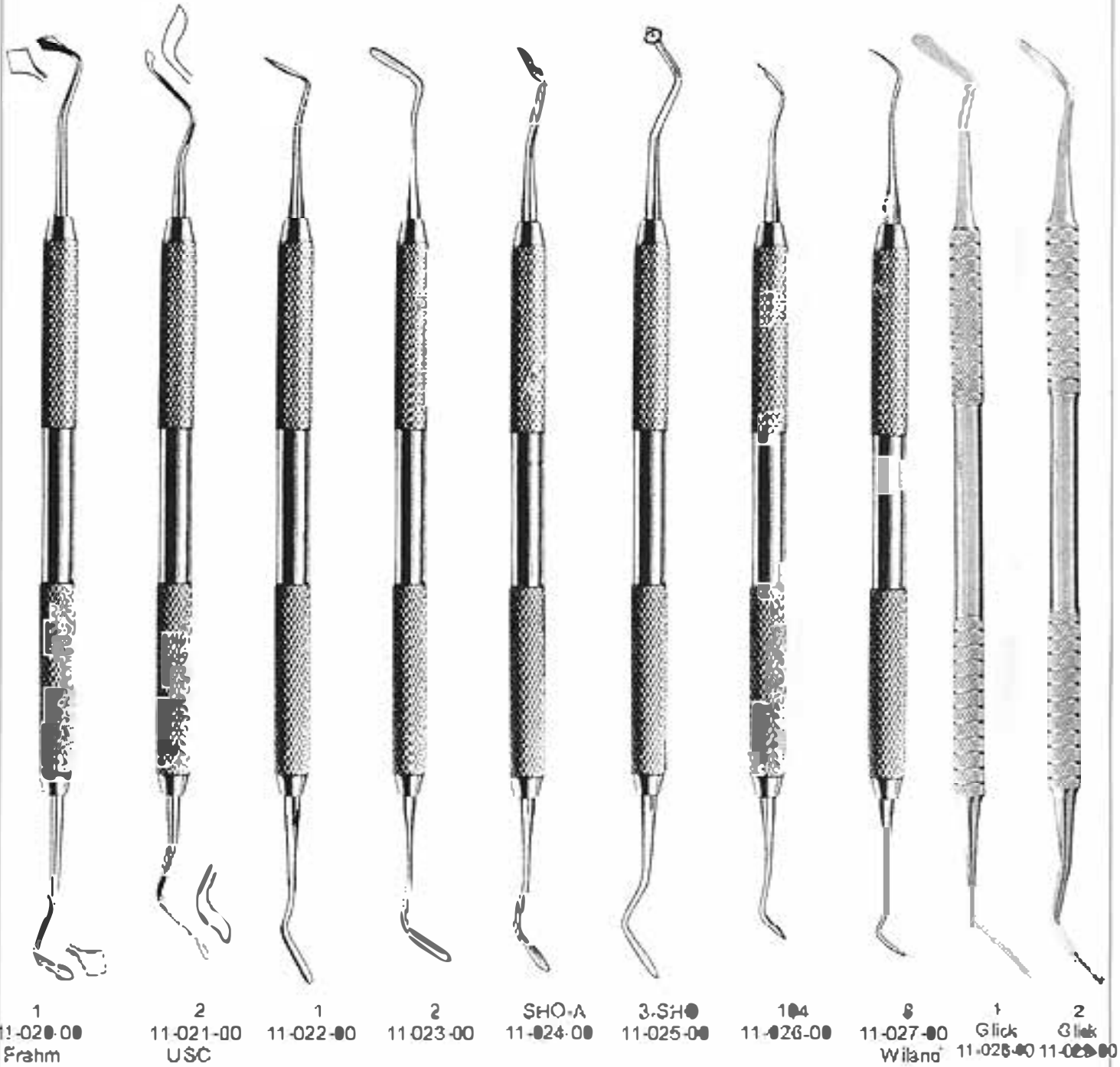
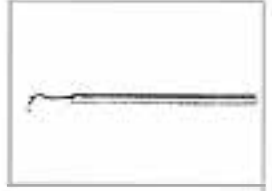

1  
11-020-00  
Frahm

2  
11-021-00  
USC

1  
11-022-00

2  
11-023-00

SHO-A  
11-024-00

3-SH●  
11-025-00

104  
11-026-00

6  
11-027-00  
Wiland

1  
11-028-00  
Glick

2  
11-029-00  
Glick

Department

12

BONE CURETTES  
SCHARFE LOFFEL  
CURETAS OSEAS

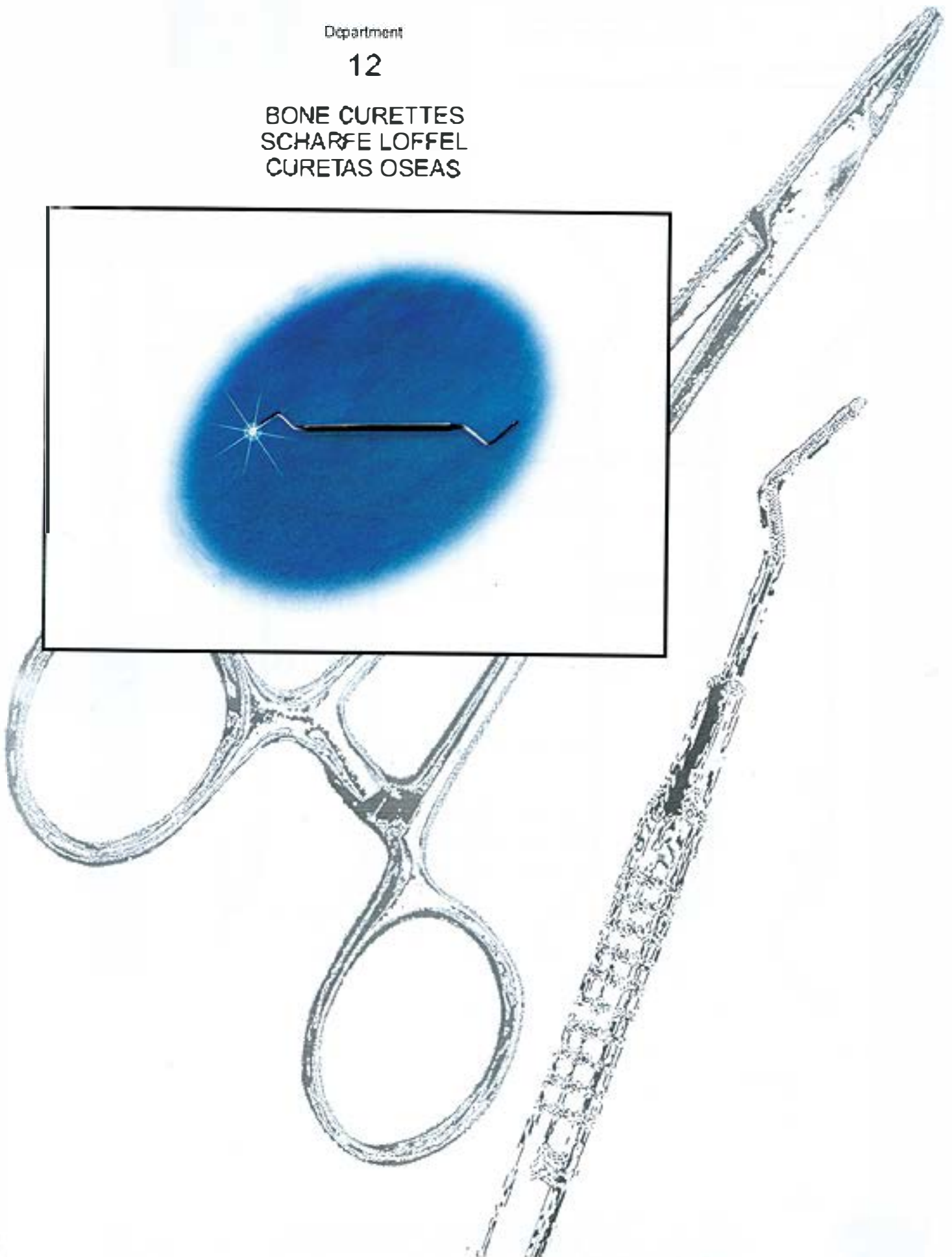
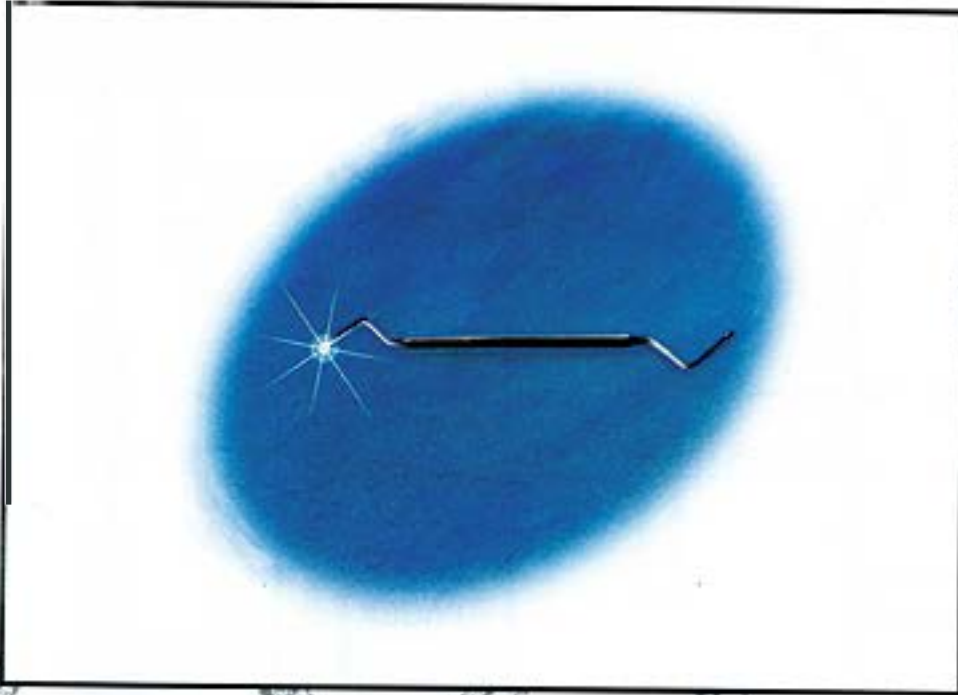

DEPARTMENT NO. 12

---

FROM  
PAGE#

169

TO  
PAGE#

176

INSTRUMENTS CATEGORY

BONE CURETTES  
SCHARFE LOFFEL  
CURETAS ● SEAS



1  
 1.4  
 12-001-01  
 17 cm  
 Williger



2 12-001-02



3 12-001-03



4 12-001-04



0  
 12-002-00



1  
 12-002-01



2  
 0.3 12-002-02



3  
 12-002-03



8  
 12-003-08



9  
 8.9 12-003-09

12-002-17  
 17 cm

Hemingway

12-003-17  
 17 cm

Luas

BONE CURETTES  
SCHARFE LOFFEL  
CURETAS OSEAS



1  
12-004-17  
17 cm



2  
12-005-17  
17 cm

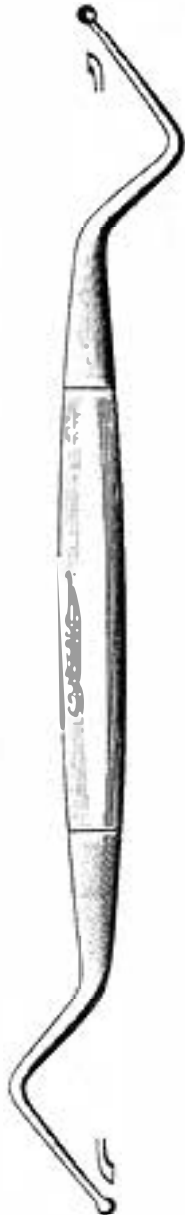

1  
12-006-00

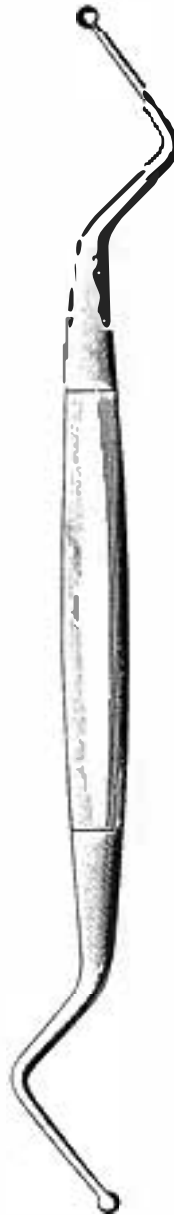

2  
12-007-00



2  
12-008-00  
Parisch



12-009-17  
17 cm



**BONE CURETTES  
SCHARFE LOFFEL  
CURETAS OSEAS**



12-010-18  
18.5 cm  
Molt

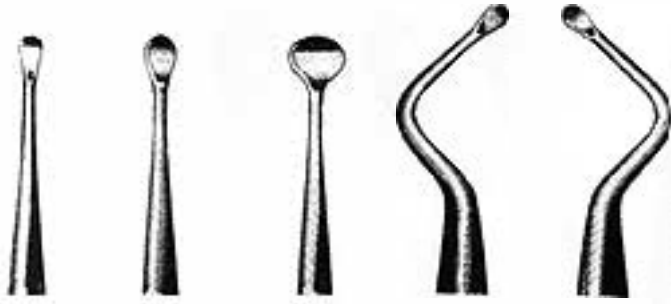

1

2

4

5L

5R

12-010-01

12-010-02

12-010-04

12-010-5L

12-010-5R

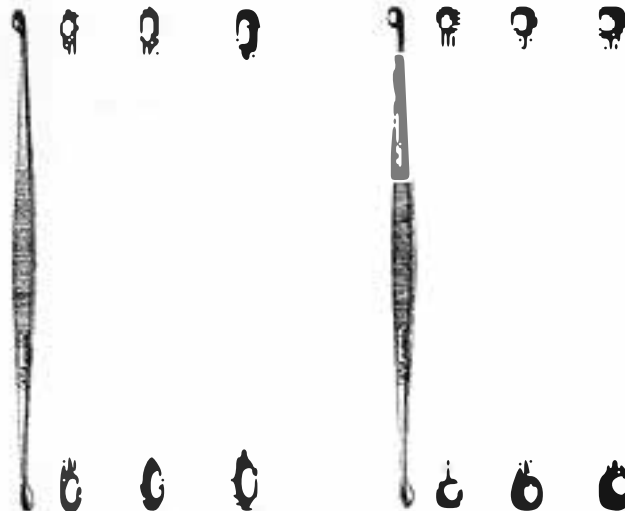

0/0

0/1

0/2

0/0

0/1

0/2

12-011-14  
14 cm  
Willger

12-012-14  
14 cm  
Majūni

12-013-17  
17.5 cm  
Willger

12-011-0/0 12-011-0/1 12-011-0/2 12-012-0/0 12-012-0/1 12-012-0/2



BONE CURETTES  
SCHARFE LOFFEL  
CURETAS OSEAS



12-014-17  
17 cm  
Volkman



12-015-1L 12-015-1R



12-016-2L 12-016-2R

1  
12-015-16  
16 cm  
U.S.A. Model

2  
12-016-16  
16 cm  
U.S.A. Model

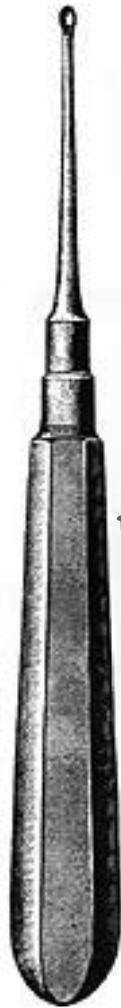
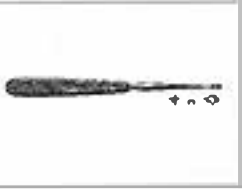

1-8  
 12-017-14  
 14 cm  
 KeP01



2

17-017-02



3

17-017-03



5

17-017-05



1-8  
 12-018-14  
 14 cm



1

12-018-01



4

12-018-04



5

12-018-05



7

12-017-07



8

12-017-08



7

12-018-07



8

12-018-08

BONE CURETTES  
SCHARFE LOFFEL  
CURETAS OSEAS

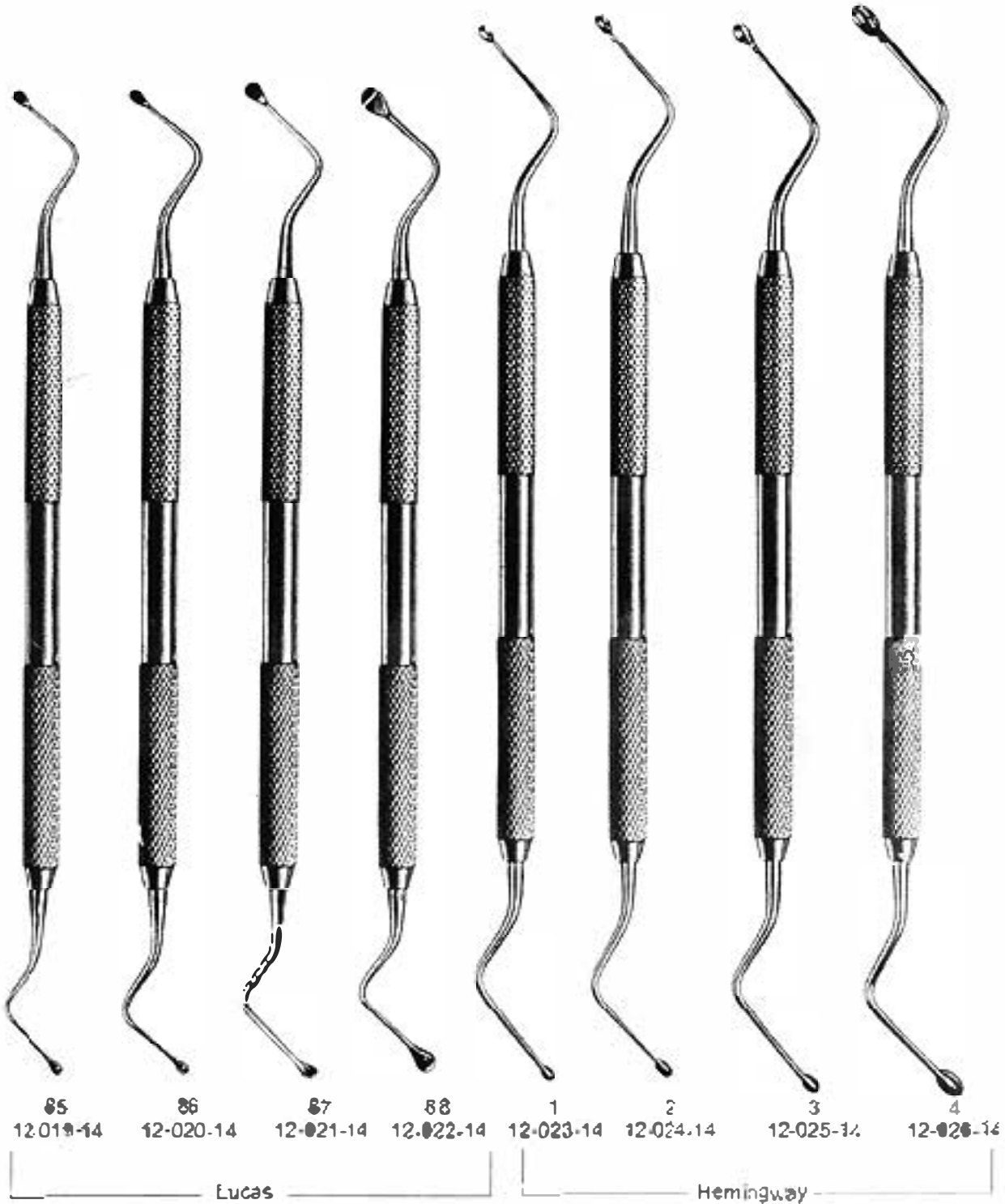

Department

13

FILLING INSTRUMENTS  
INSTRUMENTS POUR PLOMBAGE  
INSTRUMENTOS PARA OBTURACIONES

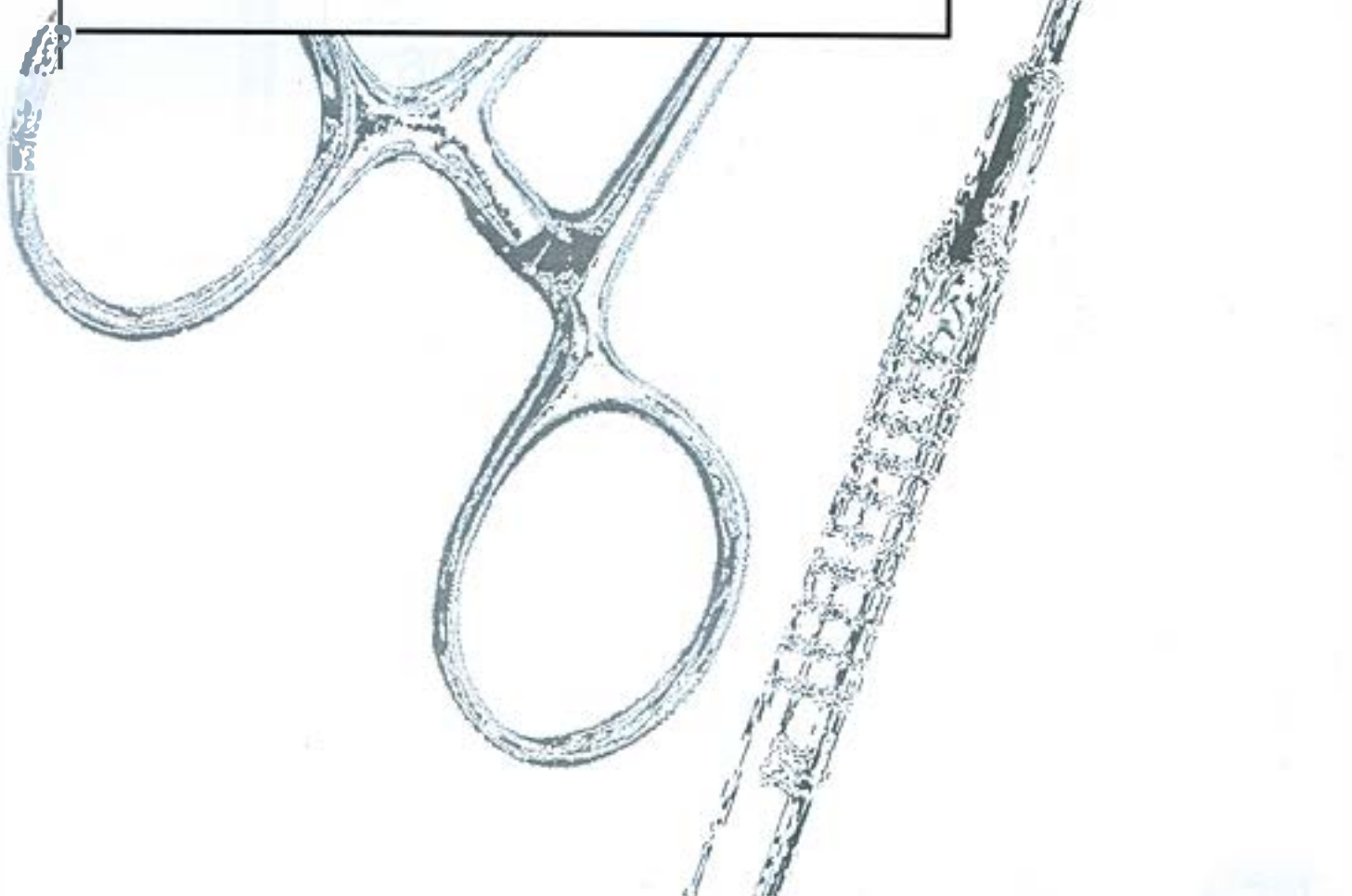
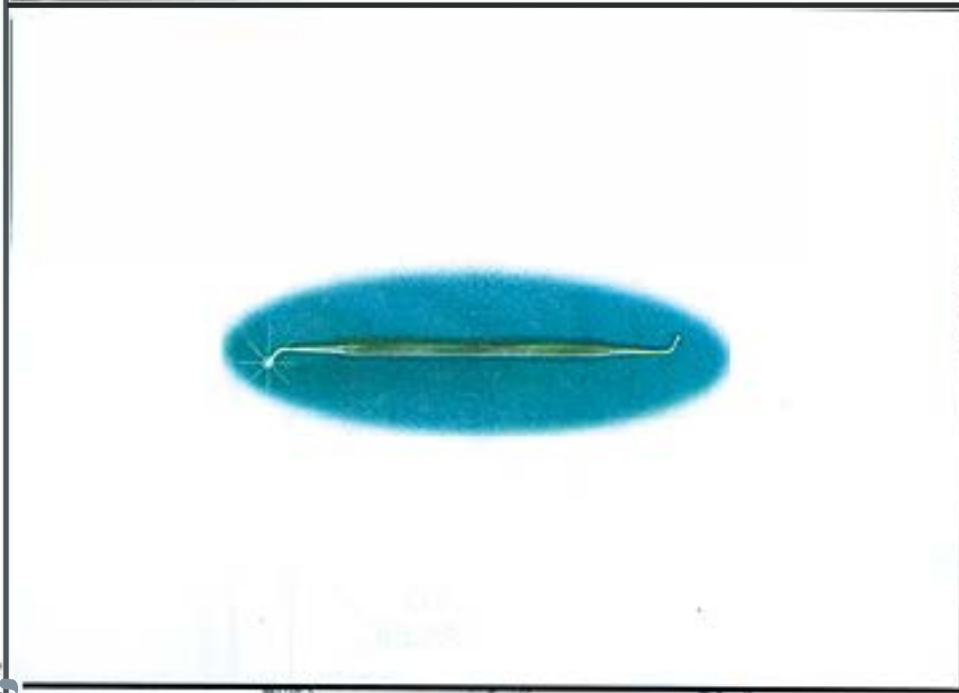

DEPARTMENT NO. 13

---

FROM  
PAGE#

177

TO  
PAGE#

206

INSTRUMENTS CATEGORY

FILLING INSTRUMENTS  
INSTRUMENTS POUR PLOMBAGE  
INSTRUMENTOS PARA OBTURACIONES

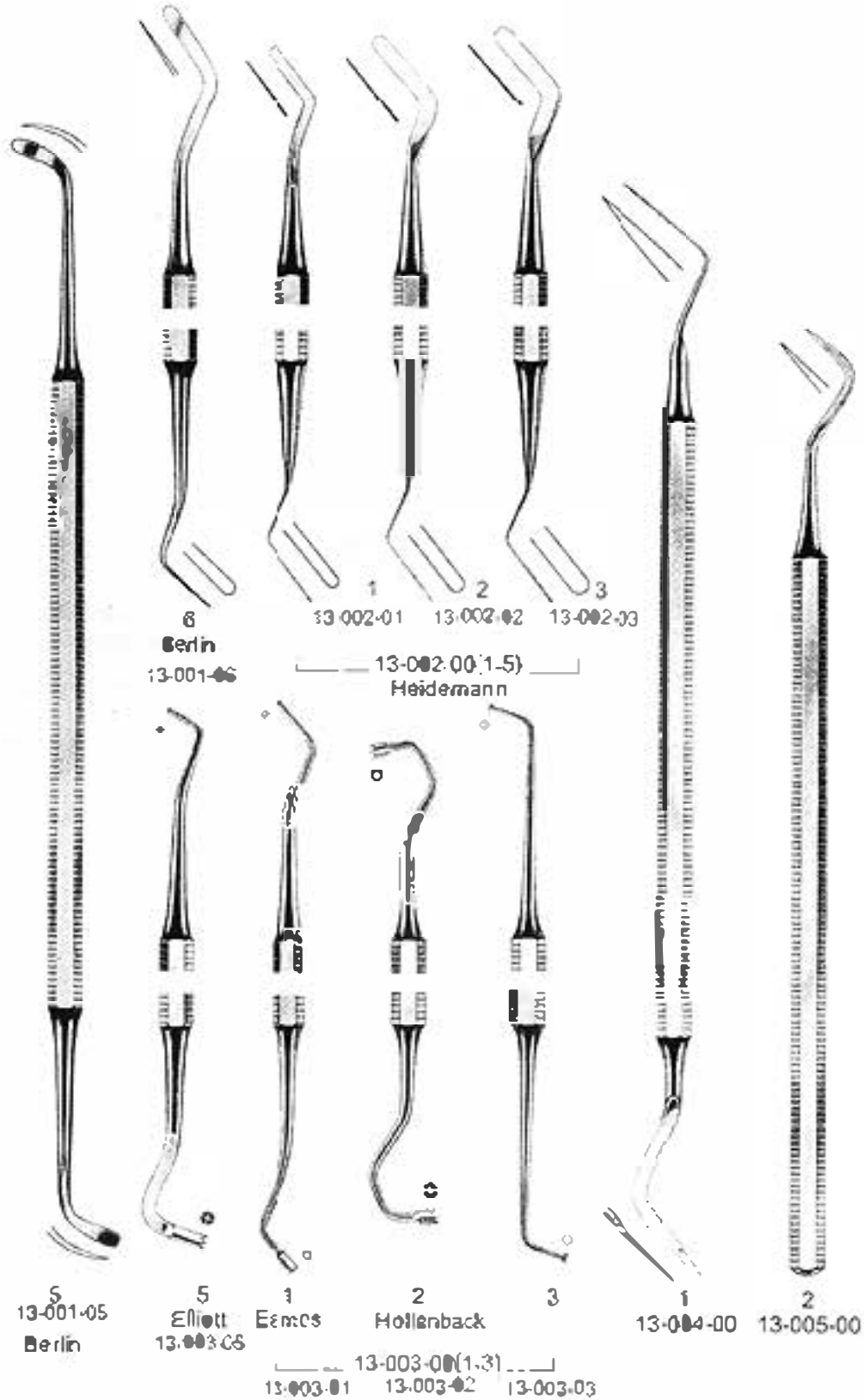

FILLING INSTRUMENTS  
 INSTRUMENTS POUR PLOMBAGE  
 INSTRUMENTOS PARA OBTURACIONES

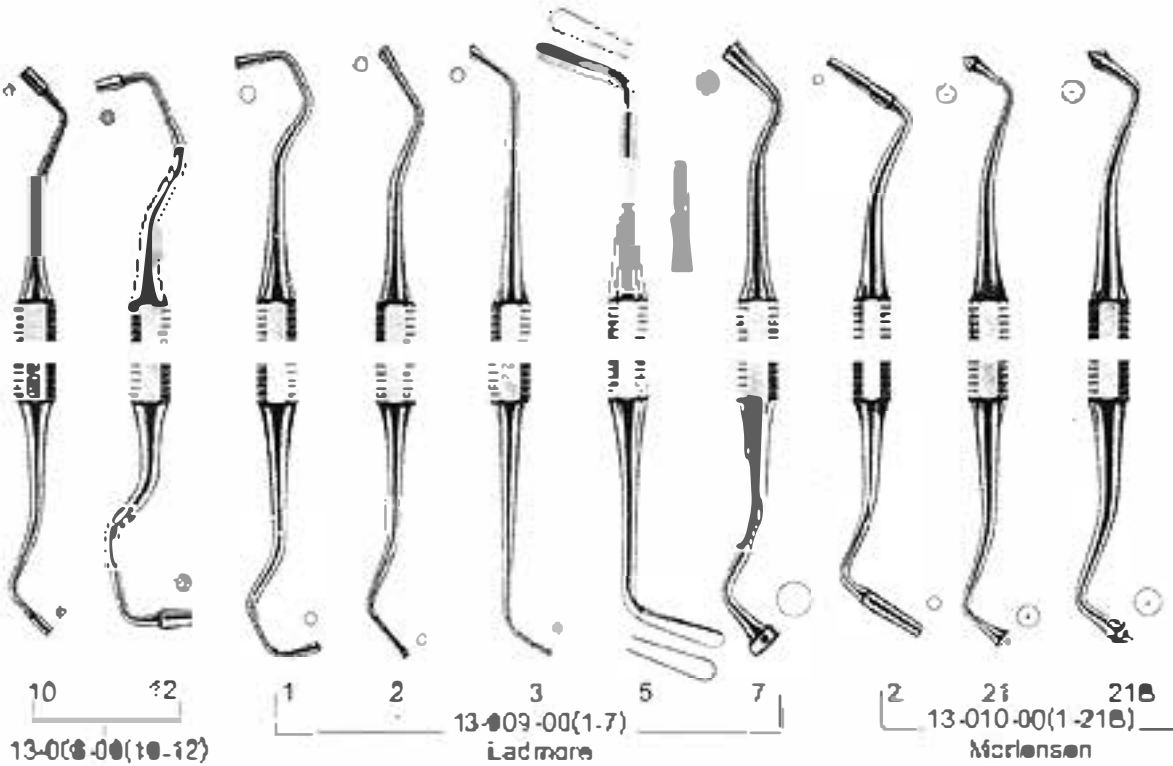

13-008-10 13-008-12 13-009-01 13-009-02 13-009-03 13-009-06 13-009-07 13-010-02 13-010-21 13-010-21B

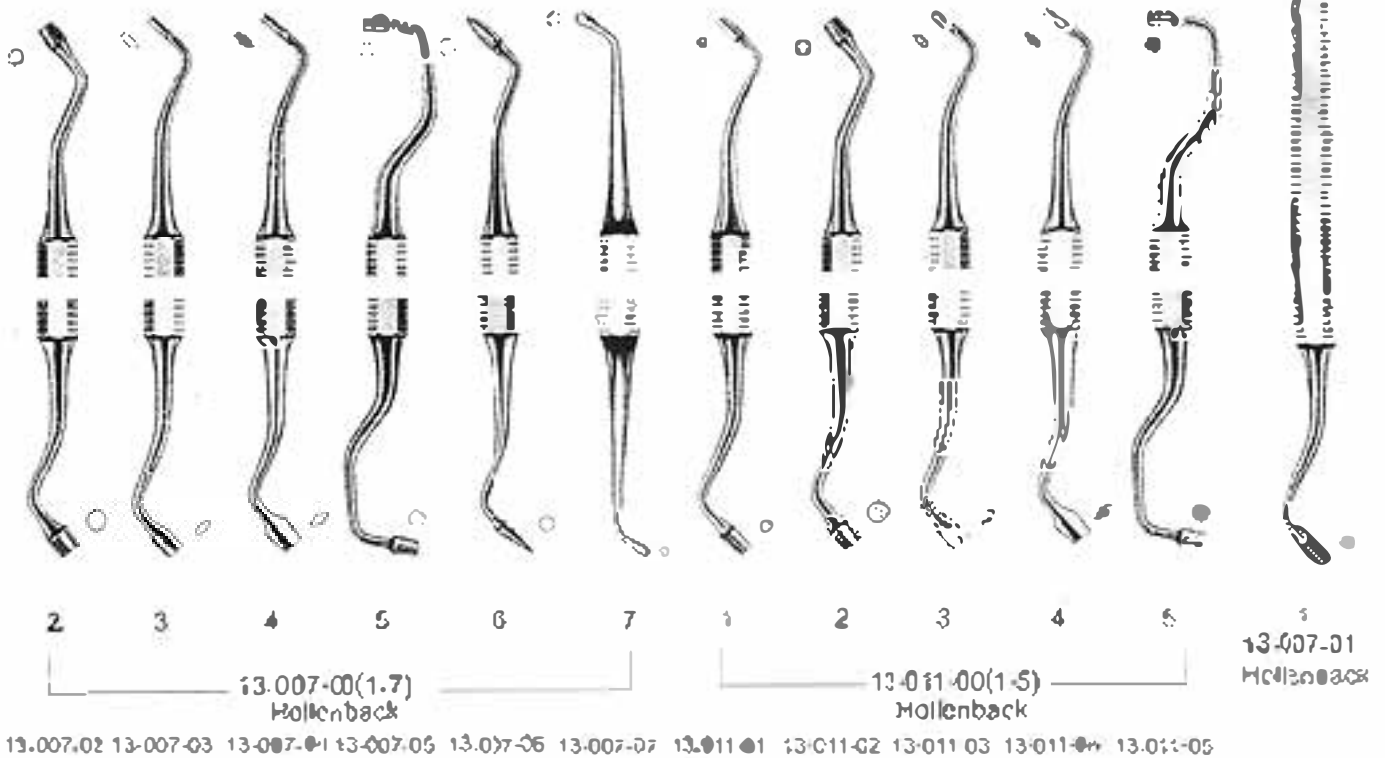

13-007-02 13-007-03 13-007-04 13-007-05 13-007-06 13-007-07 13-011-01 13-011-02 13-011-03 13-011-04 13-011-05

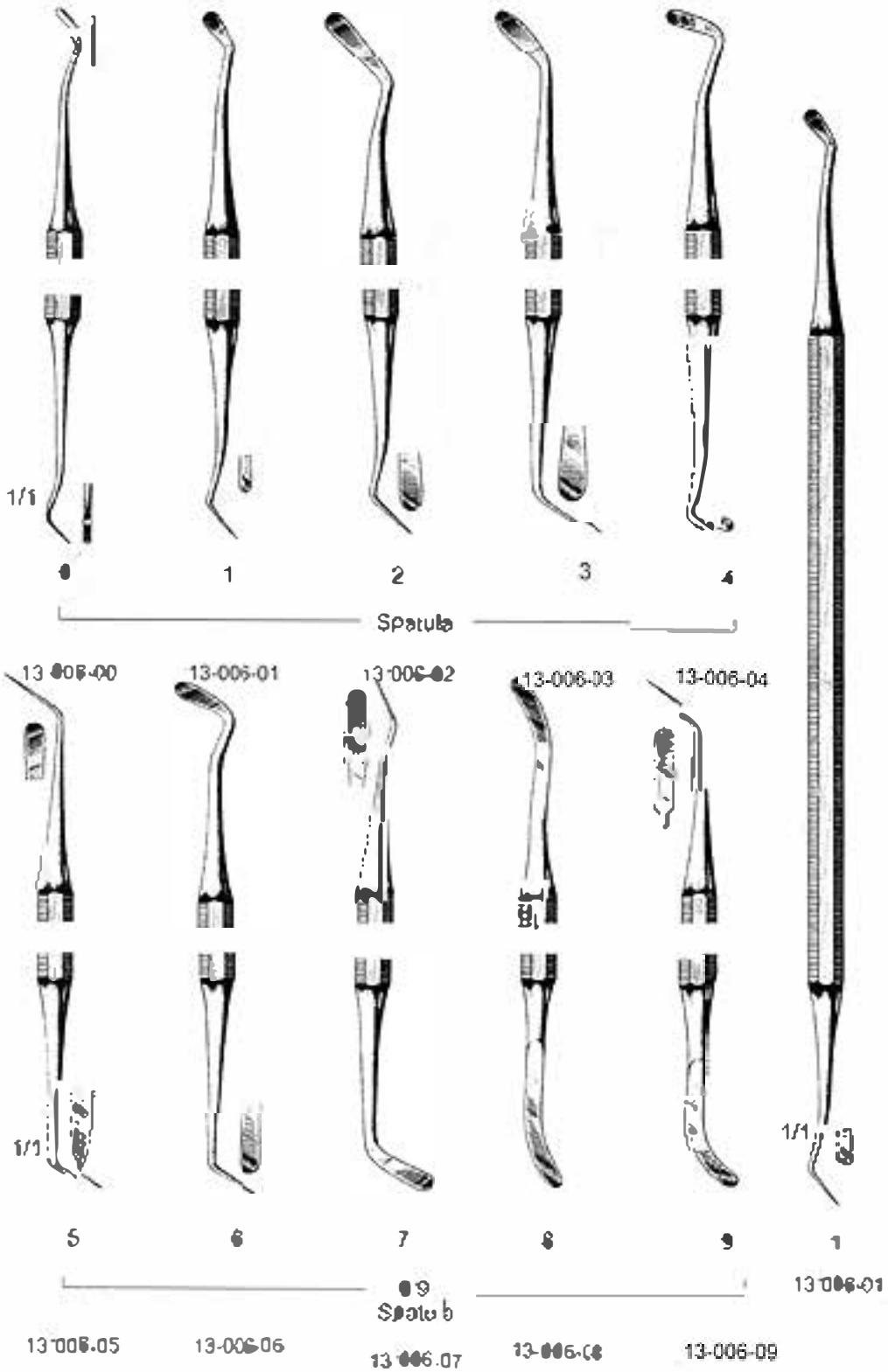



FILLING INSTRUMENTS  
 INSTRUMENTS POUR PLOMBAGE  
 INSTRUMENTOS PARA OBTURACIONES

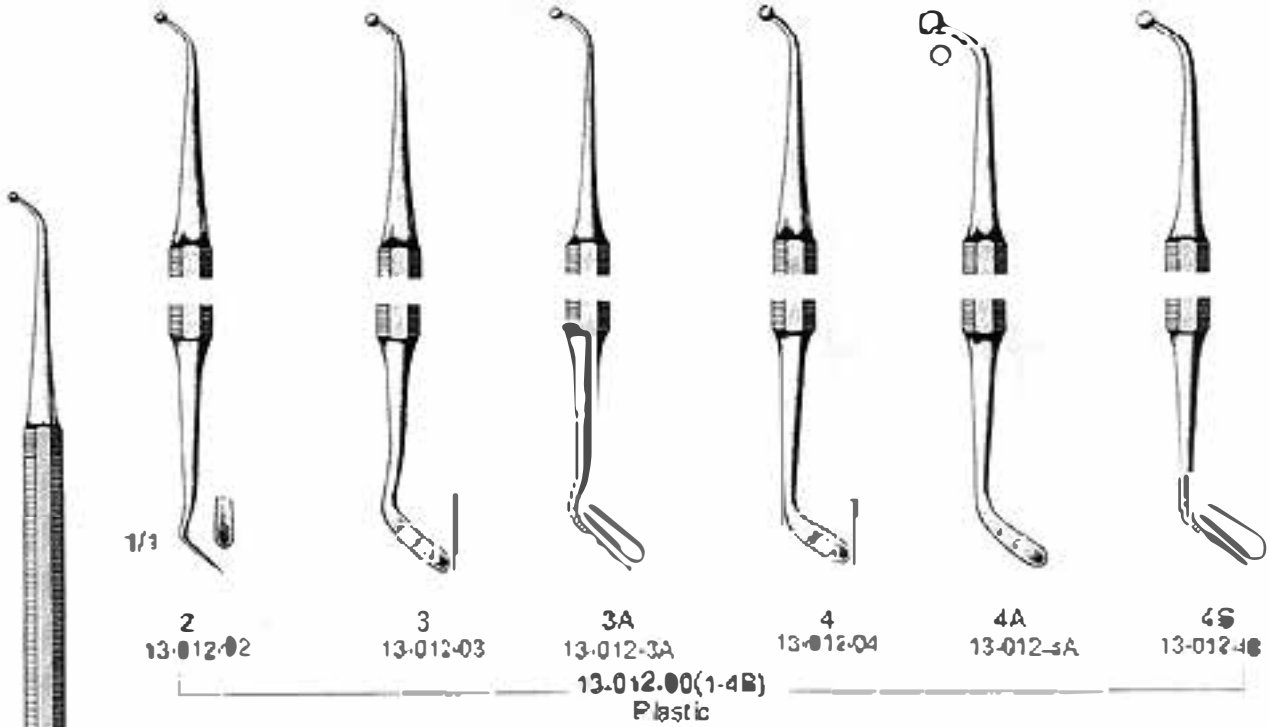

1  
 13-012-00(1-4B)  
 13-012-00(1-7)

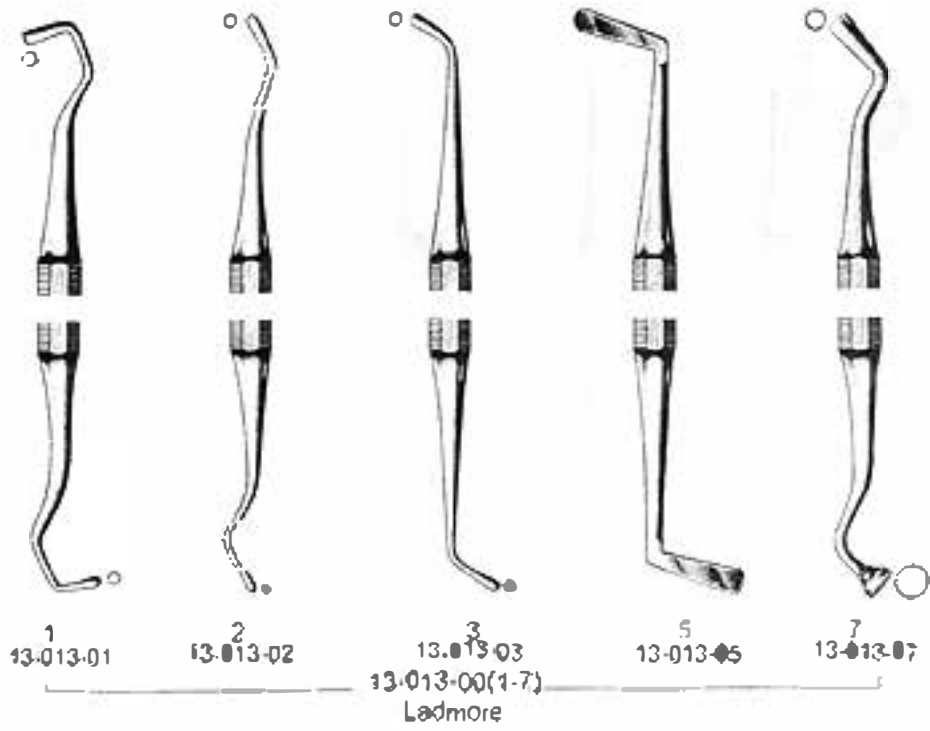

1 13-013-01  
 2 13-013-02  
 3 13-013-03  
 5 13-013-05  
 7 13-013-07  
 13-013-00(1-7)  
 Ladmore



FILING INSTRUMENTS  
 INSTRUMENTS POUR PLOMBAGE  
 INSTRUMENTOS PARA OBTURACIONES

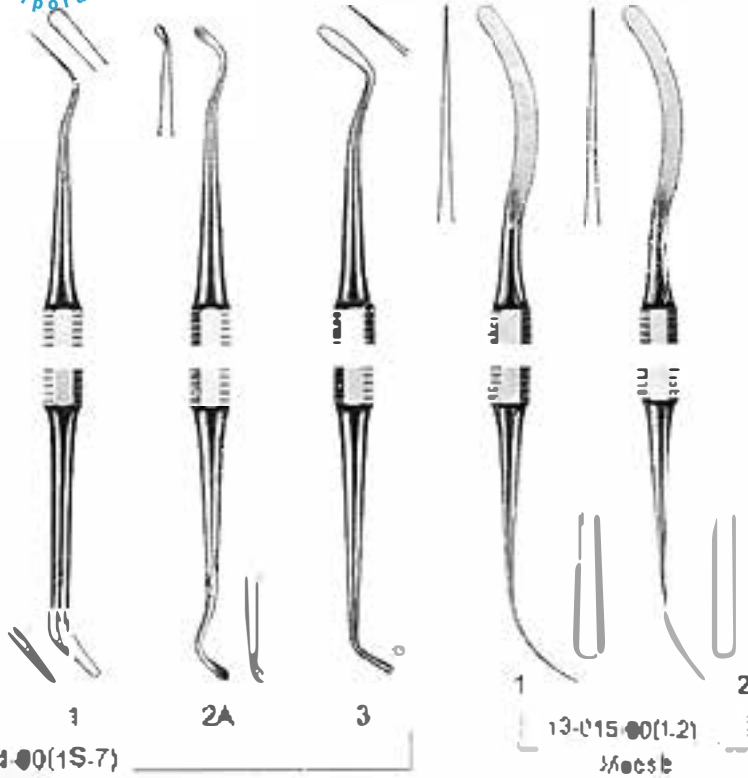

13-014-00(1S-7)  
 White

13-014-01

13-014-2A

13-014-03

13-015-A1

13-015-A2

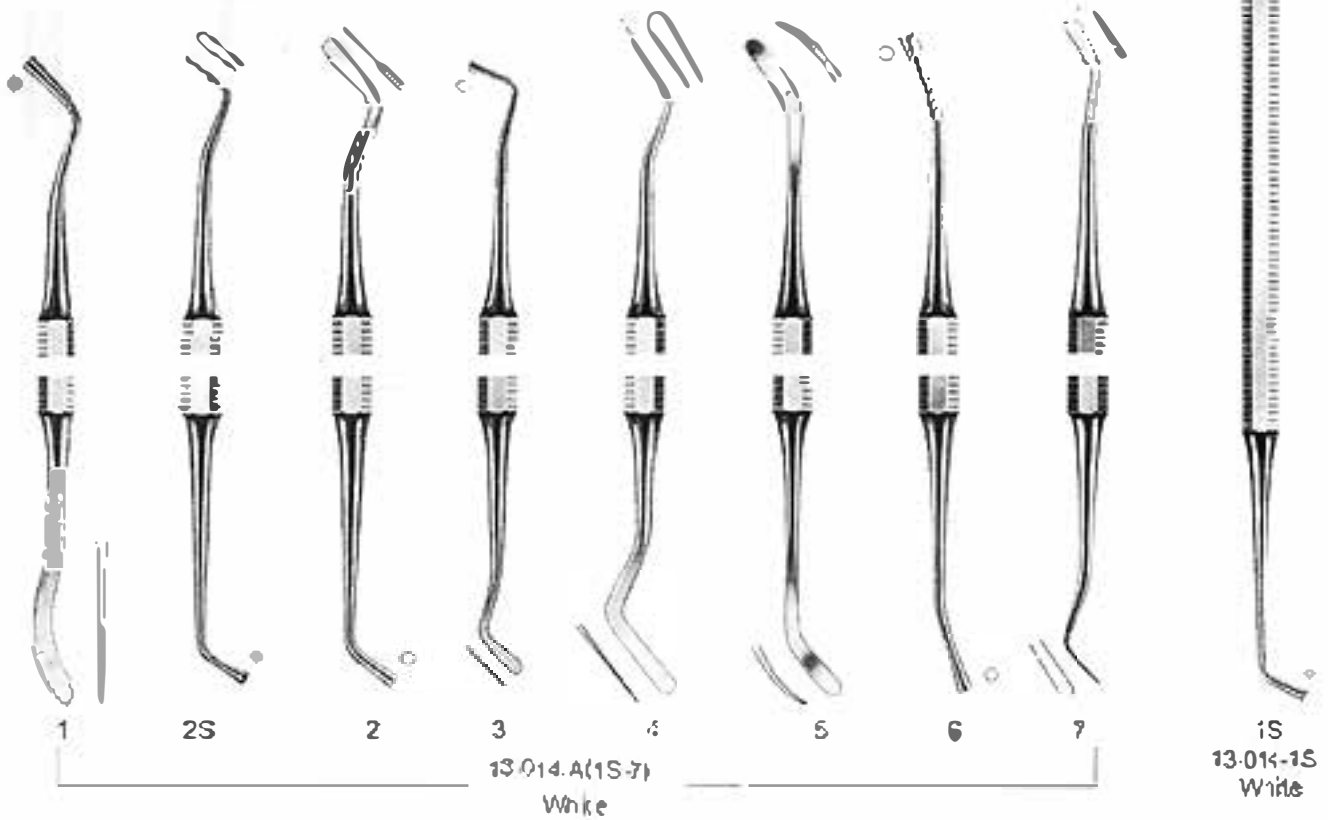

13-014-A(1S-7)  
 White

13-014-A4 13-014-A5 13-014-A6 13-014-A7

1S  
 13-014-1S  
 White

FILLING INSTRUMENTS  
INSTRUMENTS POUR PLOMBAGE  
INSTRUMENTOS PARA OBTURACIONES

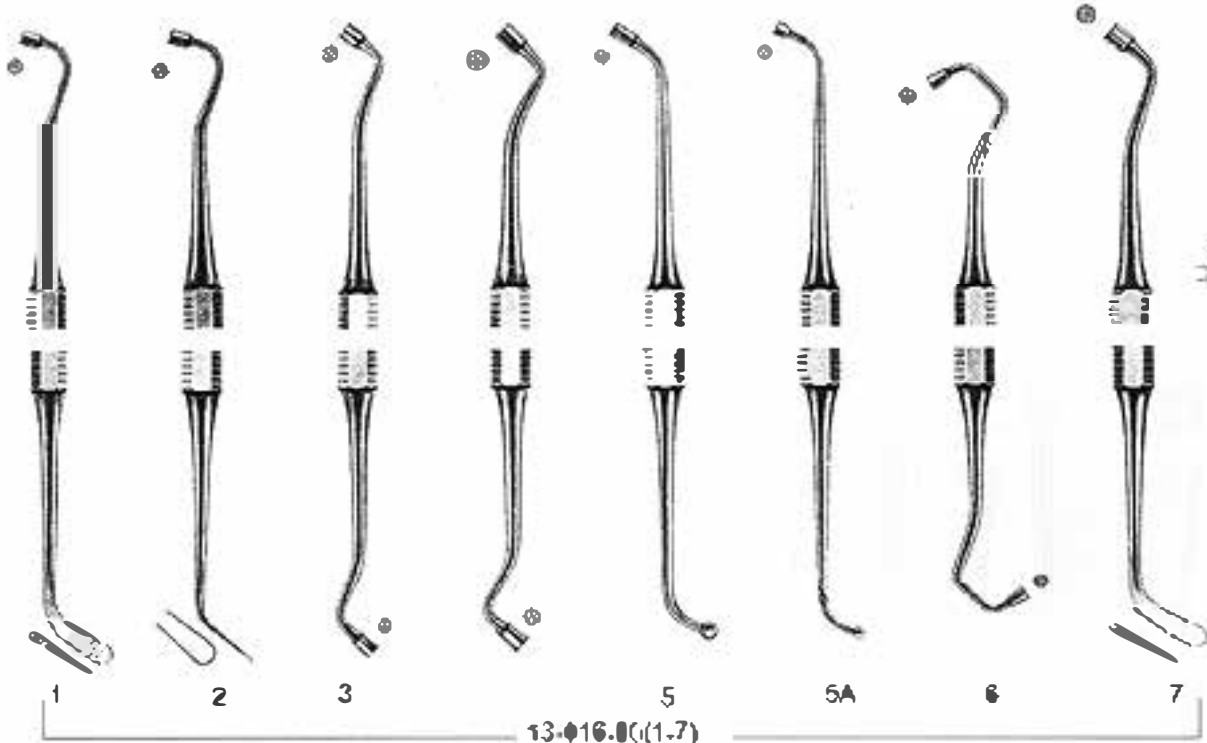

13-016.00(1-7)  
Siber

13-016-01 13-016-02 13-016-03 13-016-04 13-016-05 13-016-5A 13-016-06 13-016-07

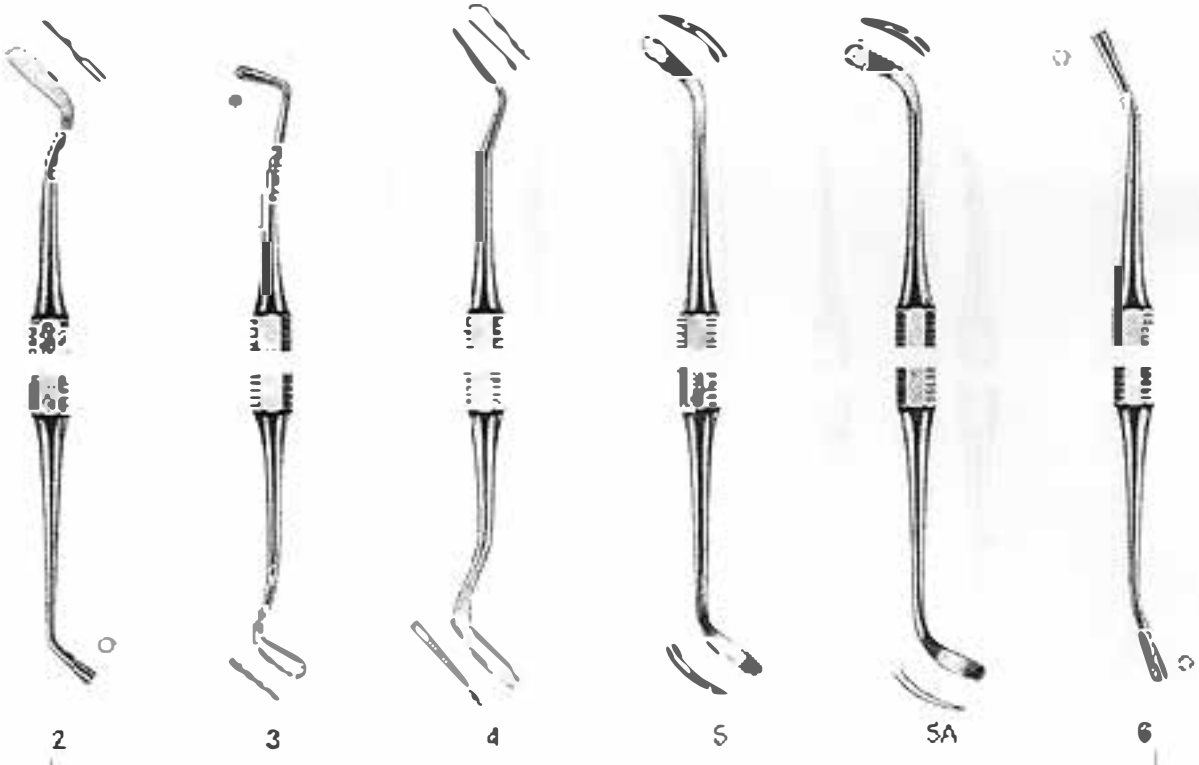

13-015.00(1-6)  
White

13-015-02 13-015-03 13-015-04 13-015-05 13-015-5A 13-015-06

13-015-01  
White



FILLING INSTRUMENTS  
 INSTRUMENTS POUR PLOMBAGE  
 INSTRUMENTOS PARA OBTURACIONES

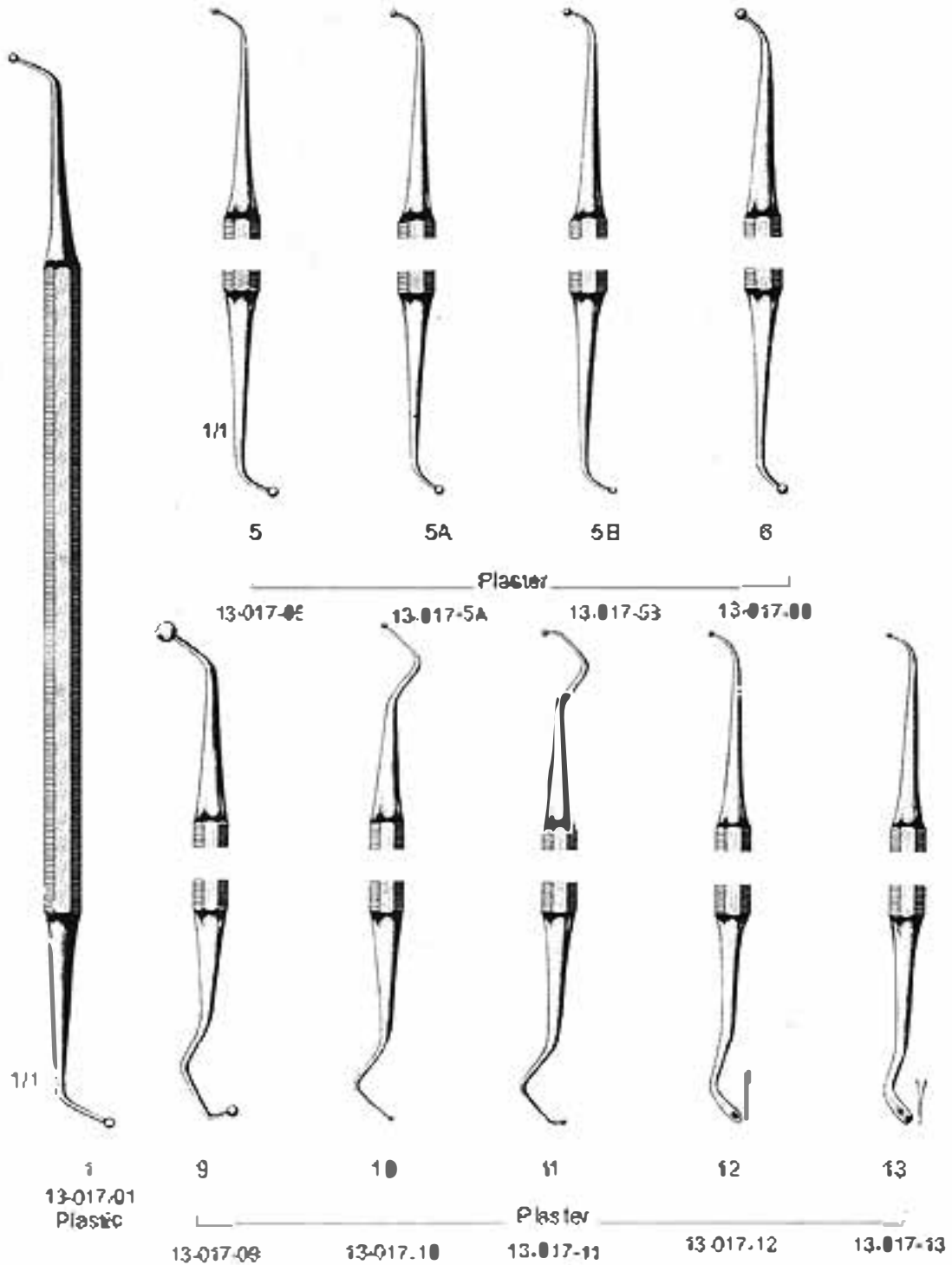

FILLING INSTRUMENTS  
INSTRUMENTS POUR PLOMBAGE  
INSTRUMENTOS PARA OBTURACIONES



7  
13-018-07



7A  
13-018-7A



7B  
13-018-7B



2  
13-018-02

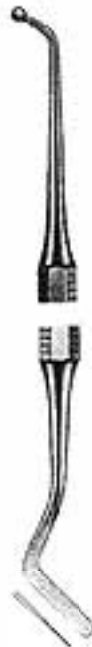

3  
13-018-03



3A  
13-018-3A



4  
13-018-04



4A  
13-018-4A

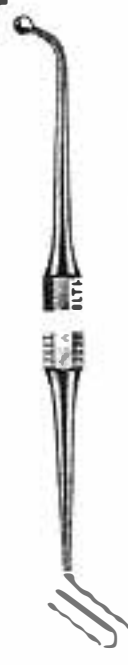

4B  
13-018-4B



1  
13-018-01



FILLING INSTRUMENTS  
 INSTRUMENTS POUR PLOMBAGE  
 INSTRUMENTOS PARA OBTURACIONES



7  
 13-018-07  
 Plastic

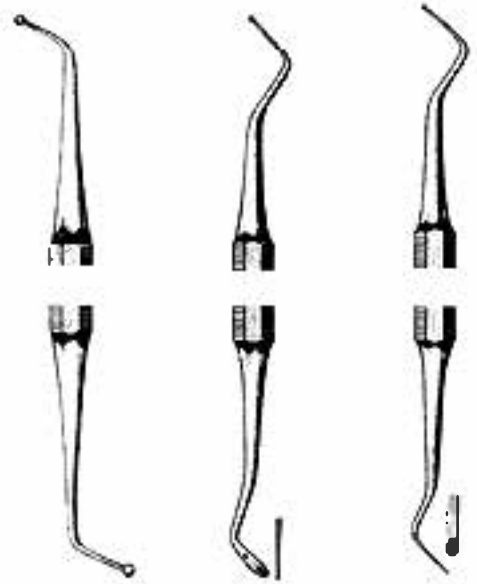

8 14 15  
 Plastic  
 13-018-08 13-018-14 13-018-15

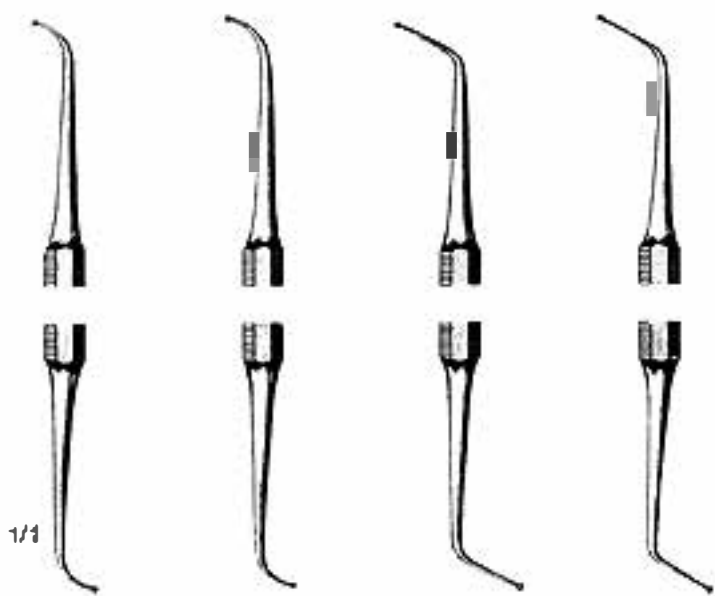

1/1 16 17 18 19  
 Plastic  
 13-018-16 13-018-17 13-018-18 13-018-19

FILLING INSTRUMENTS  
INSTRUMENTS POUR PLOMBAGE  
INSTRUMENTOS PARA OBTURACIONES

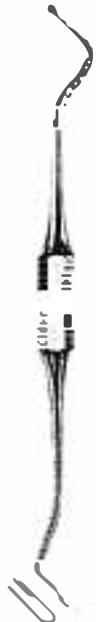

15  
13-019-15



16  
13-019-16



17  
13-019-17



18  
13-019-18



19  
13-019-19



8  
13-019-08



9  
13-019-09



10  
13-019-10



11  
13-019-11



12  
13-019-12



13  
13-019-13



14  
13-019-14

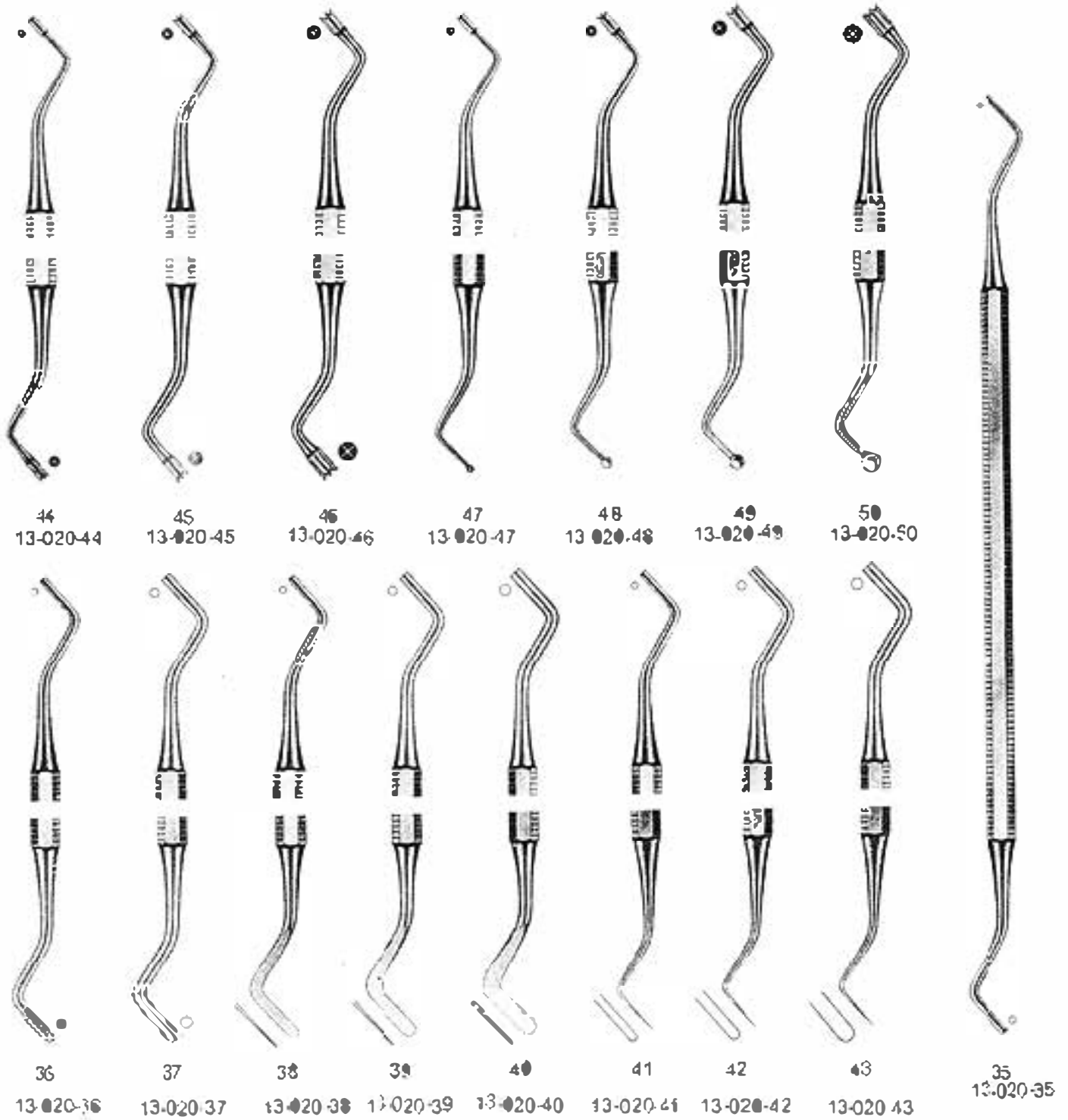



FILLING INSTRUMENTS  
INSTRUMENTS POUR PLOMBAGE  
INSTRUMENTOS PARA OBTURACIONES

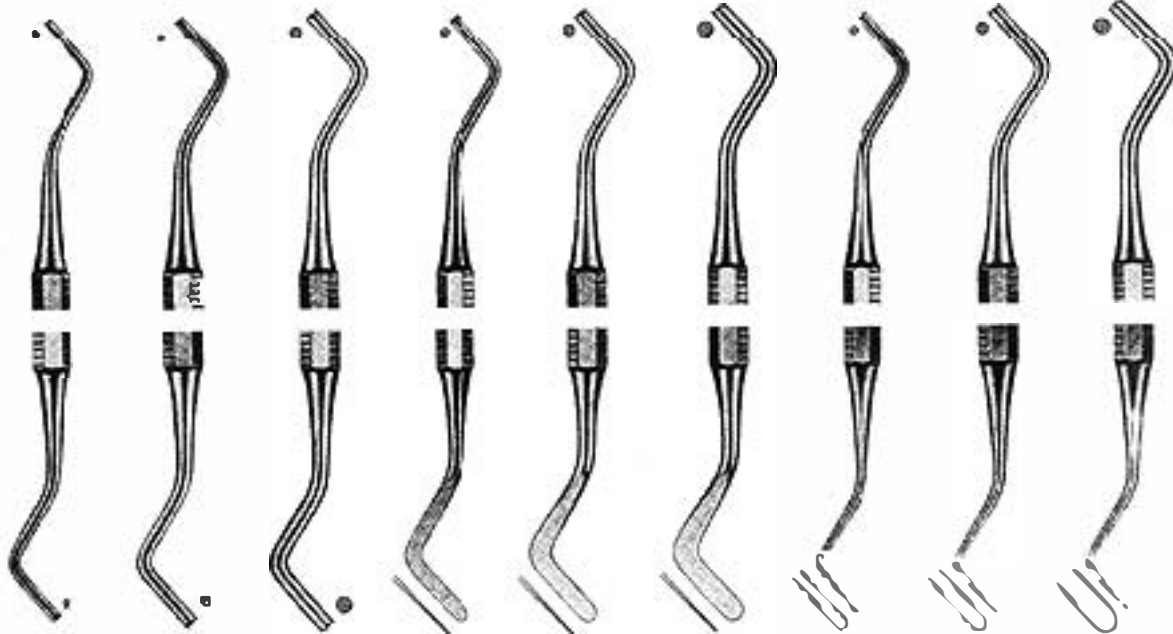

26 27 28 29 30 31 32 33 34  
13-021-26 13-021-27 13-021-28 13-021-29 13-021-30 13-021-31 13-021-32 13-021-33 13-021-34

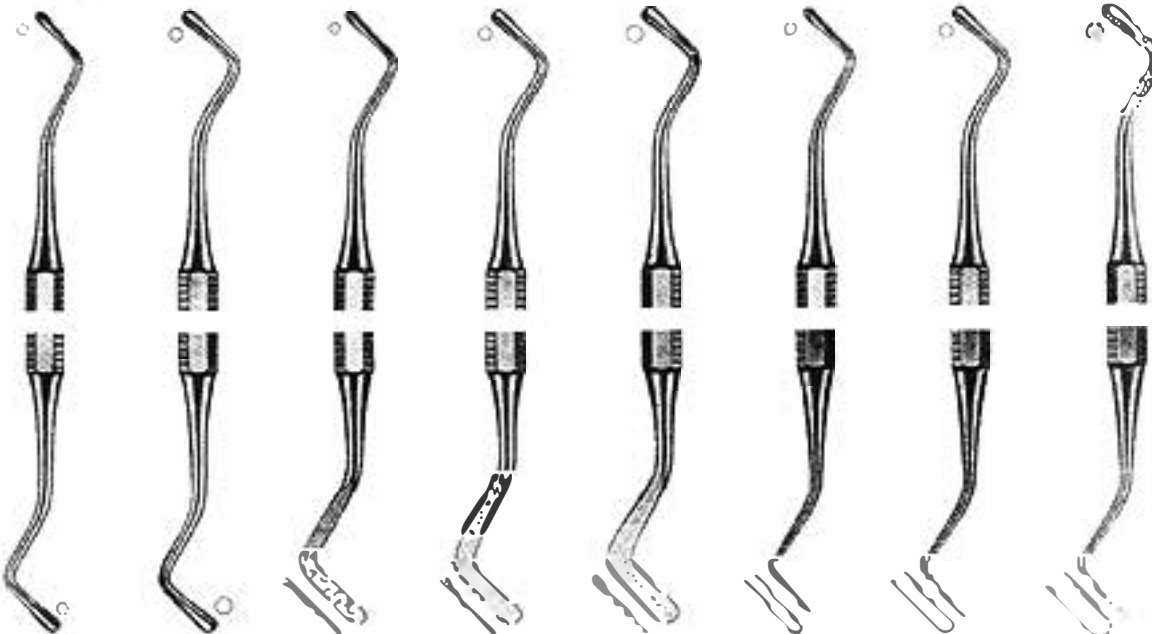

18 19 20 21 22 23 24 25  
13-021-18 13-021-19 13-021-20 13-021-21 13-021-22 13-021-23 13-021-24 13-021-25



17  
13-021-17

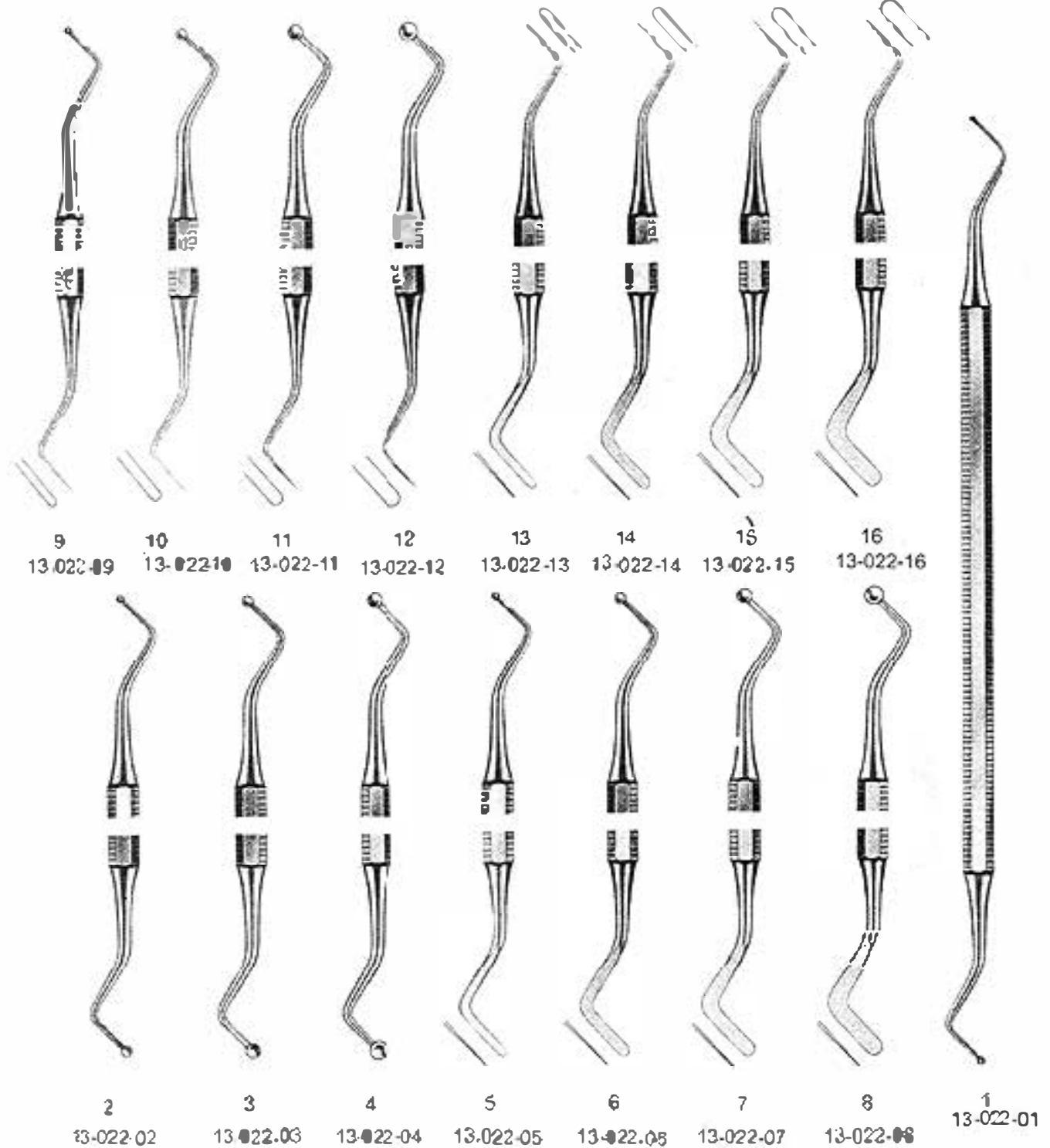

FILLING INSTRUMENTS  
INSTRUMENTS POUR PLOMBAGE  
INSTRUMENTOS PARA OBTURACIONES



64  
13-023-64



65  
13-023-65



66  
13-023-66



67  
13-023-67



181  
13-024-181



182  
13-024-182



183  
13-024-183

Ash

Ash



2  
13-025-02



3  
13-025-03



4  
13-025-04



5  
13-025-05



6  
13-025-06



7  
13-025-07



M  
13-026-0M



N  
13-026-00



13-026-00

Ash

Ash

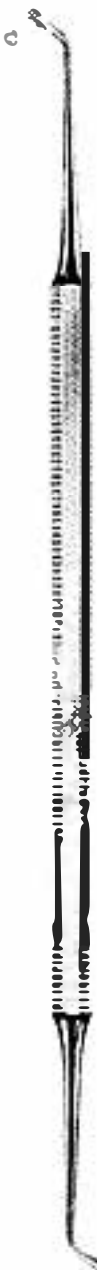

13-025-01  
ASH

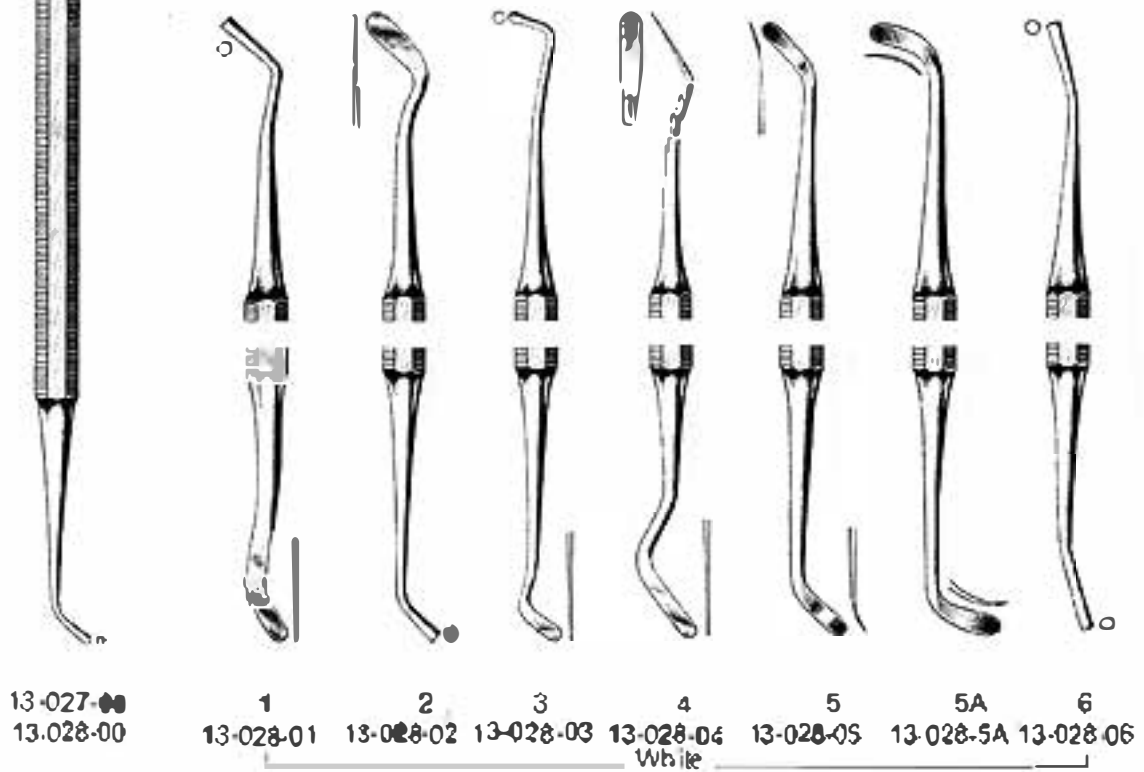
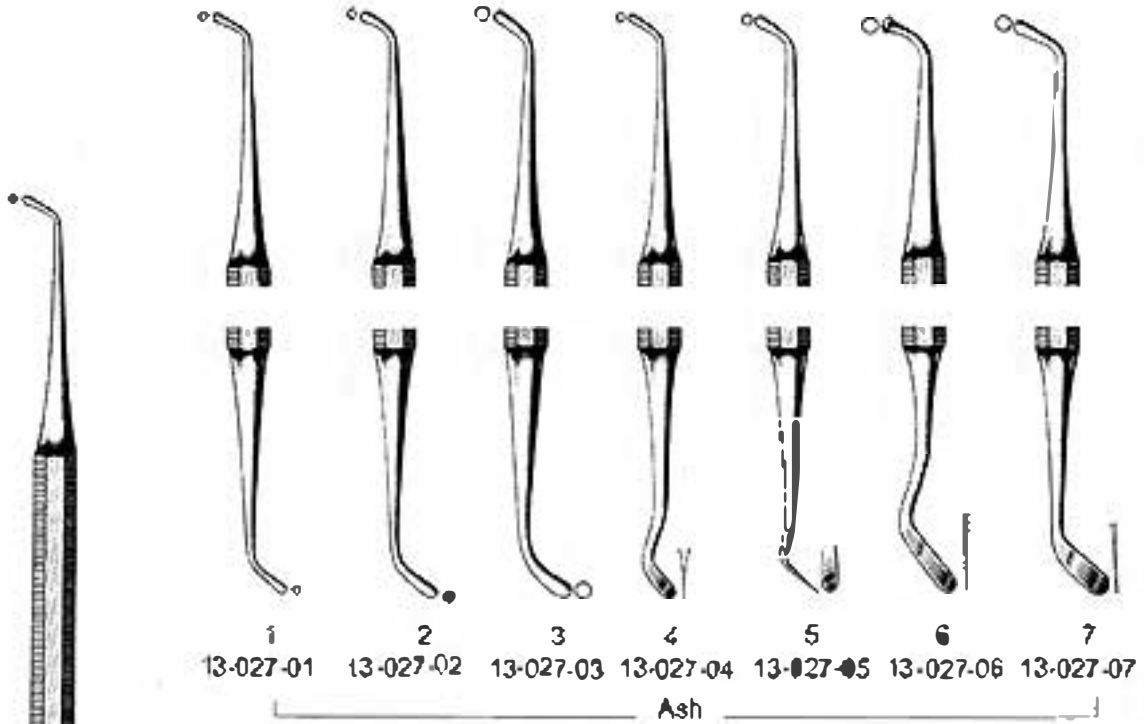

FILLING INSTRUMENTS  
INSTRUMENTS POUR PLOMBAGE  
INSTRUMENTOS PARA OBTURACIONES

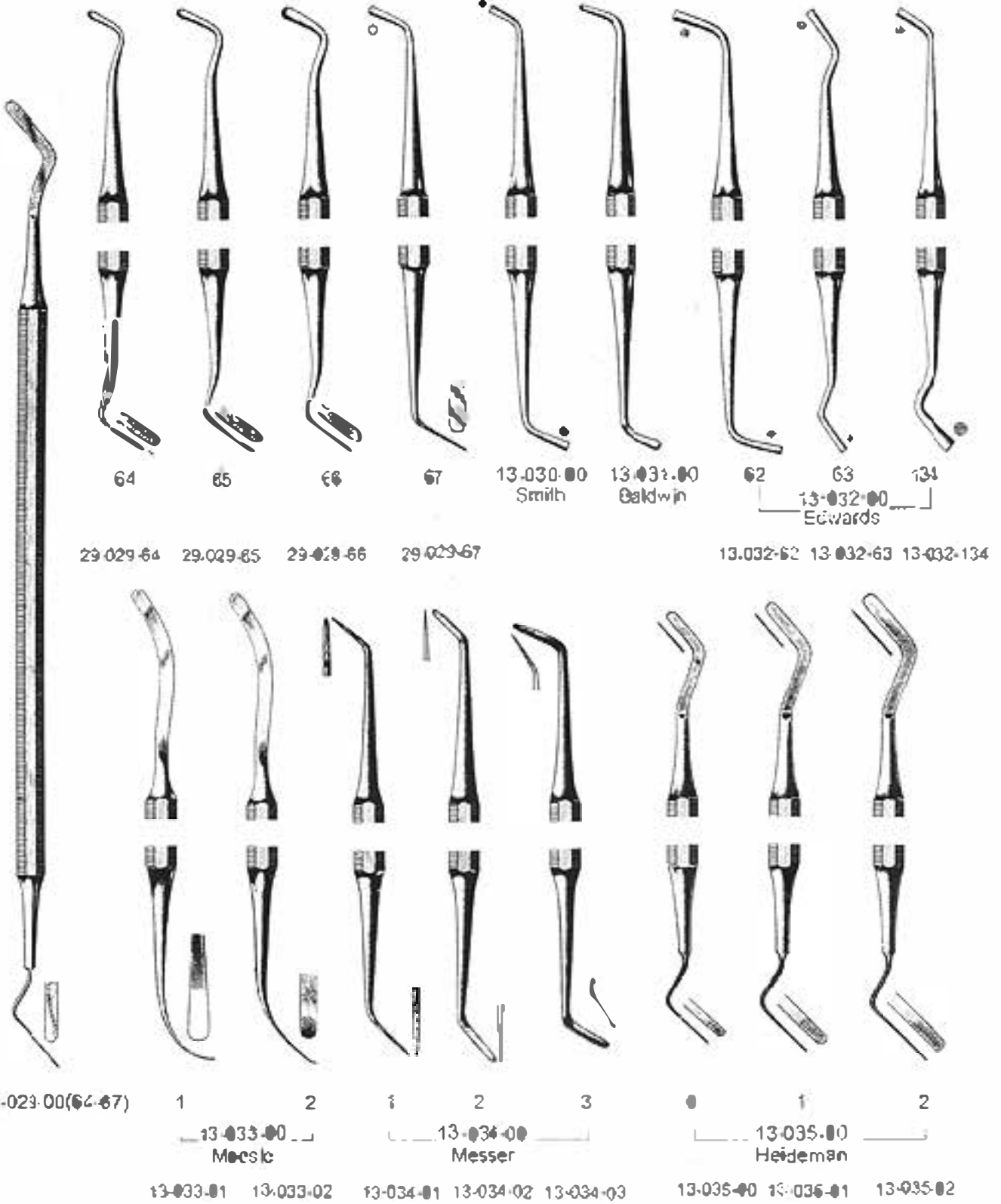
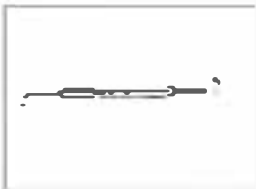

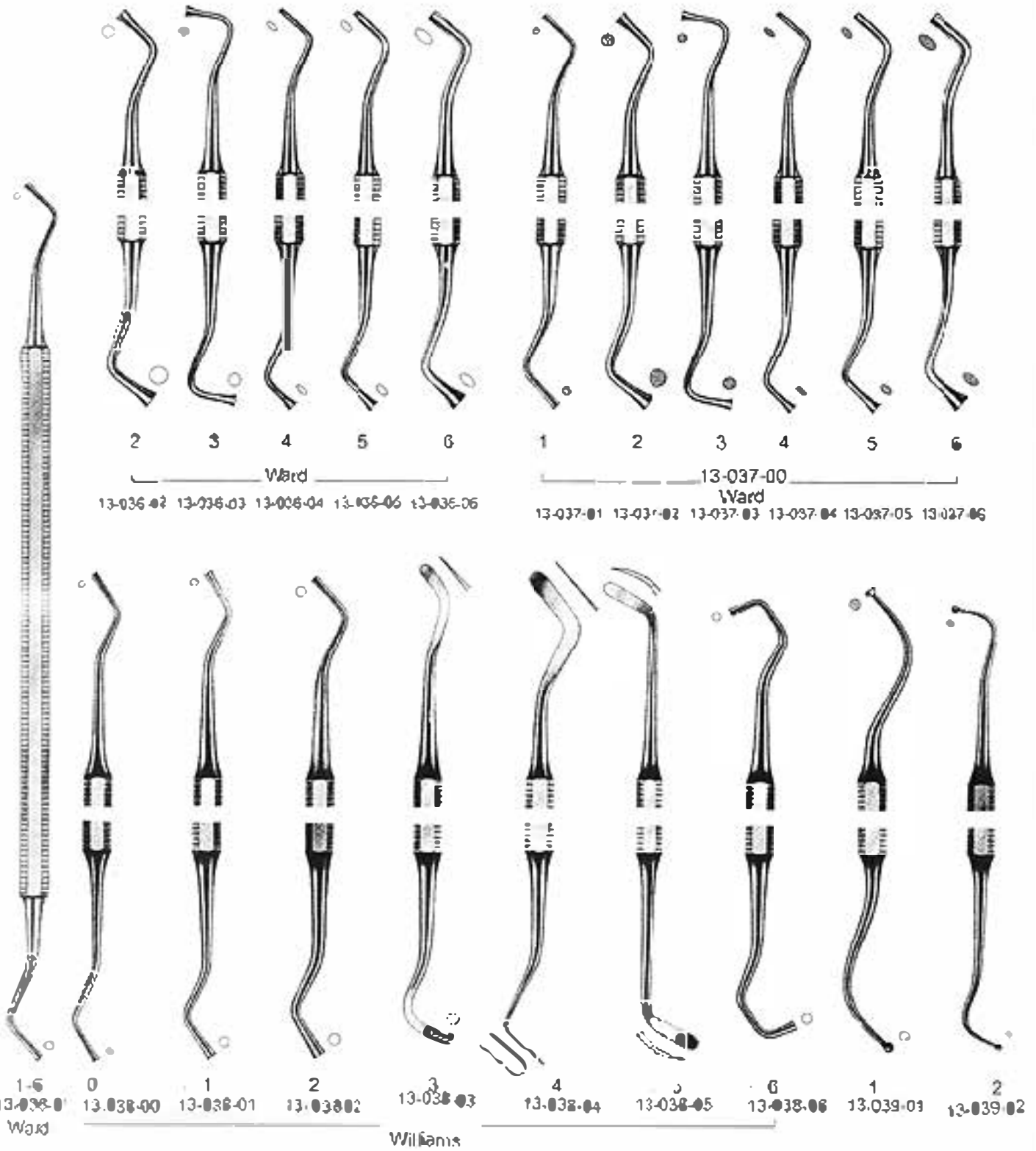

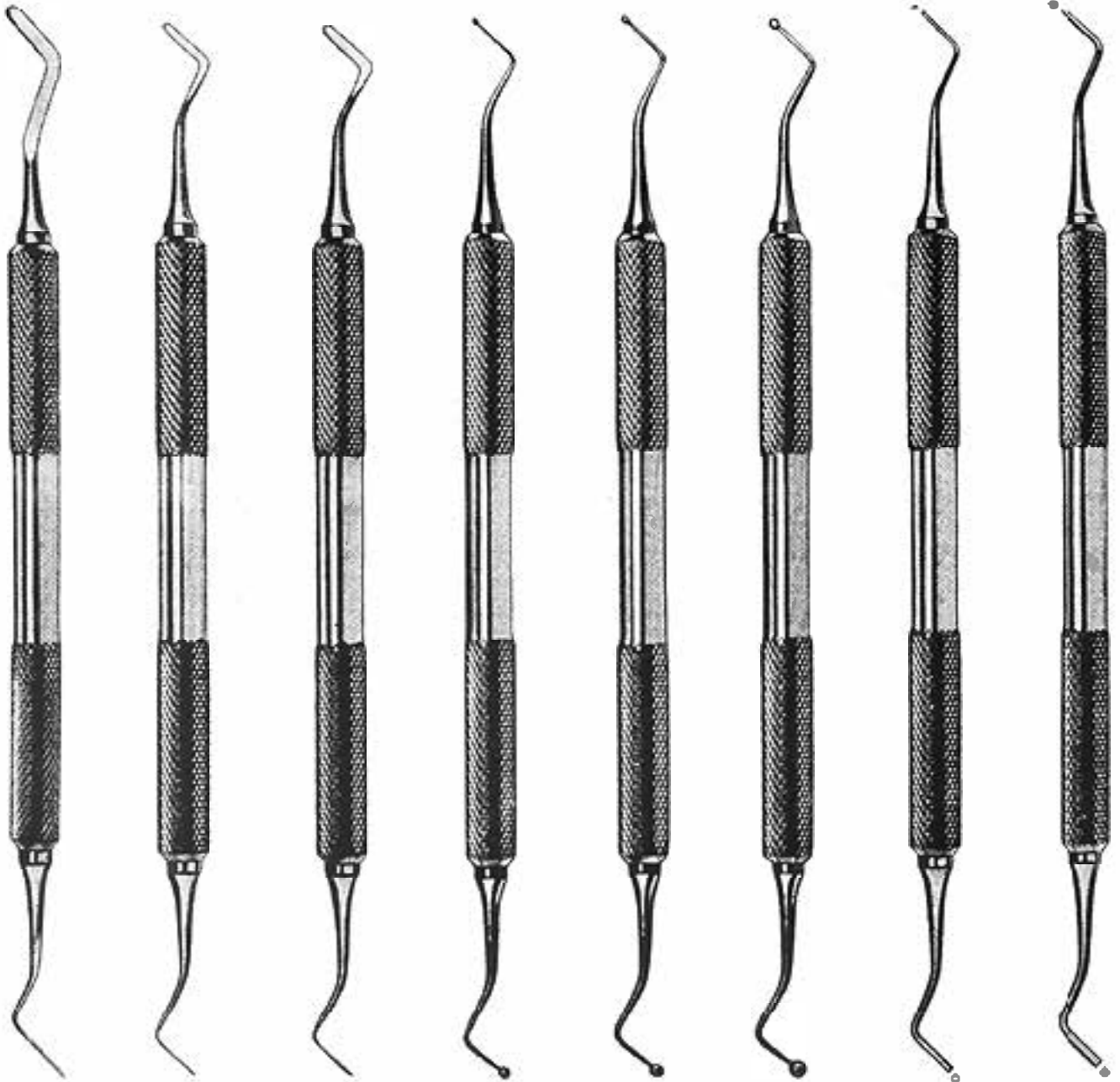

42  
13-048-00  
Hidamann

11  
13-049-00

12  
13-050-00

2  
13-051-00

4  
13-052-00

5  
13-053-00

20  
13-054-00

21  
13-055-00

FILLING INSTRUMENTS  
INSTRUMENTS POUR PLOMBAGE  
INSTRUMENTOS PARA OBTURACIONES

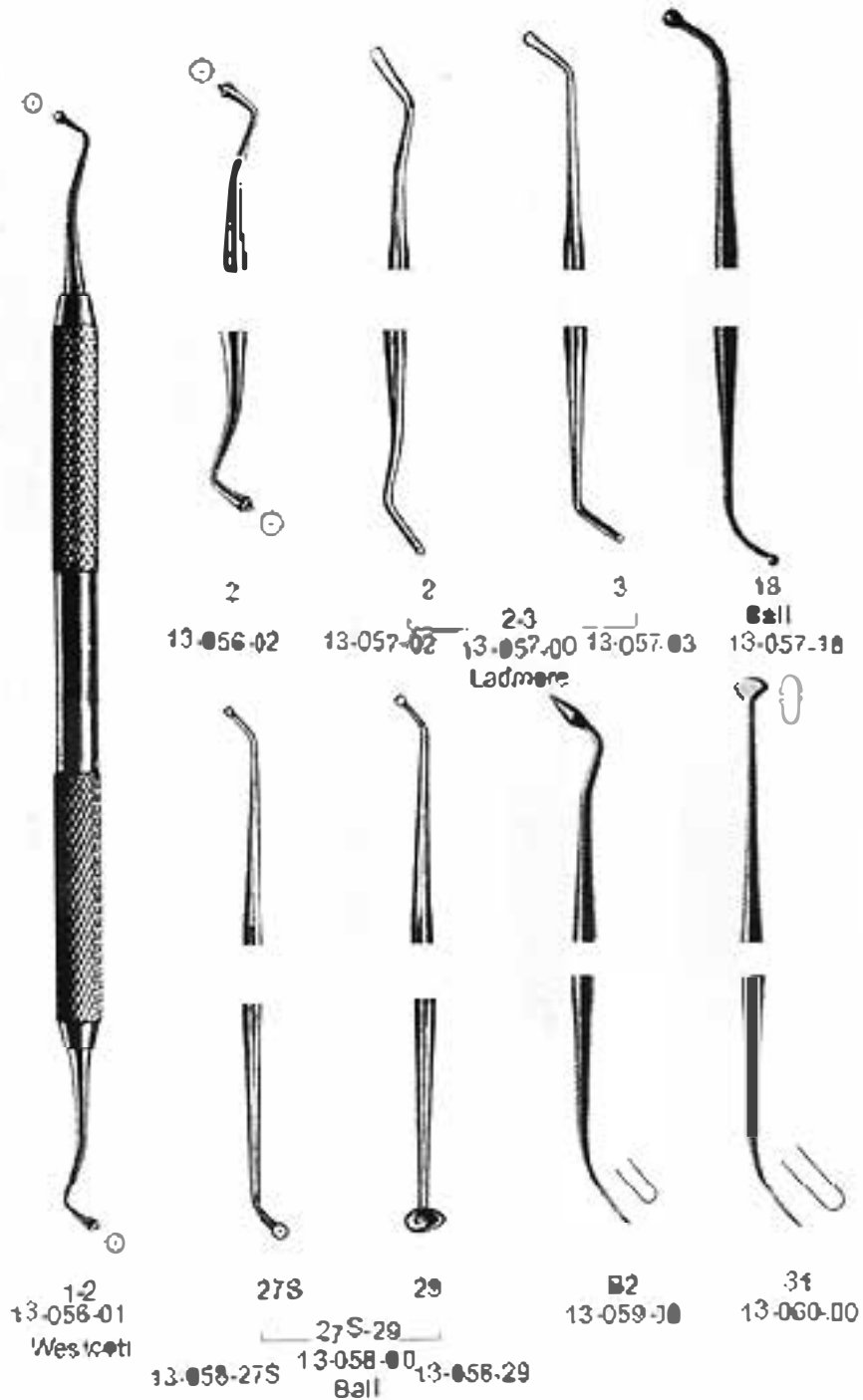
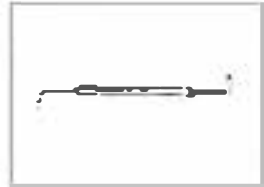



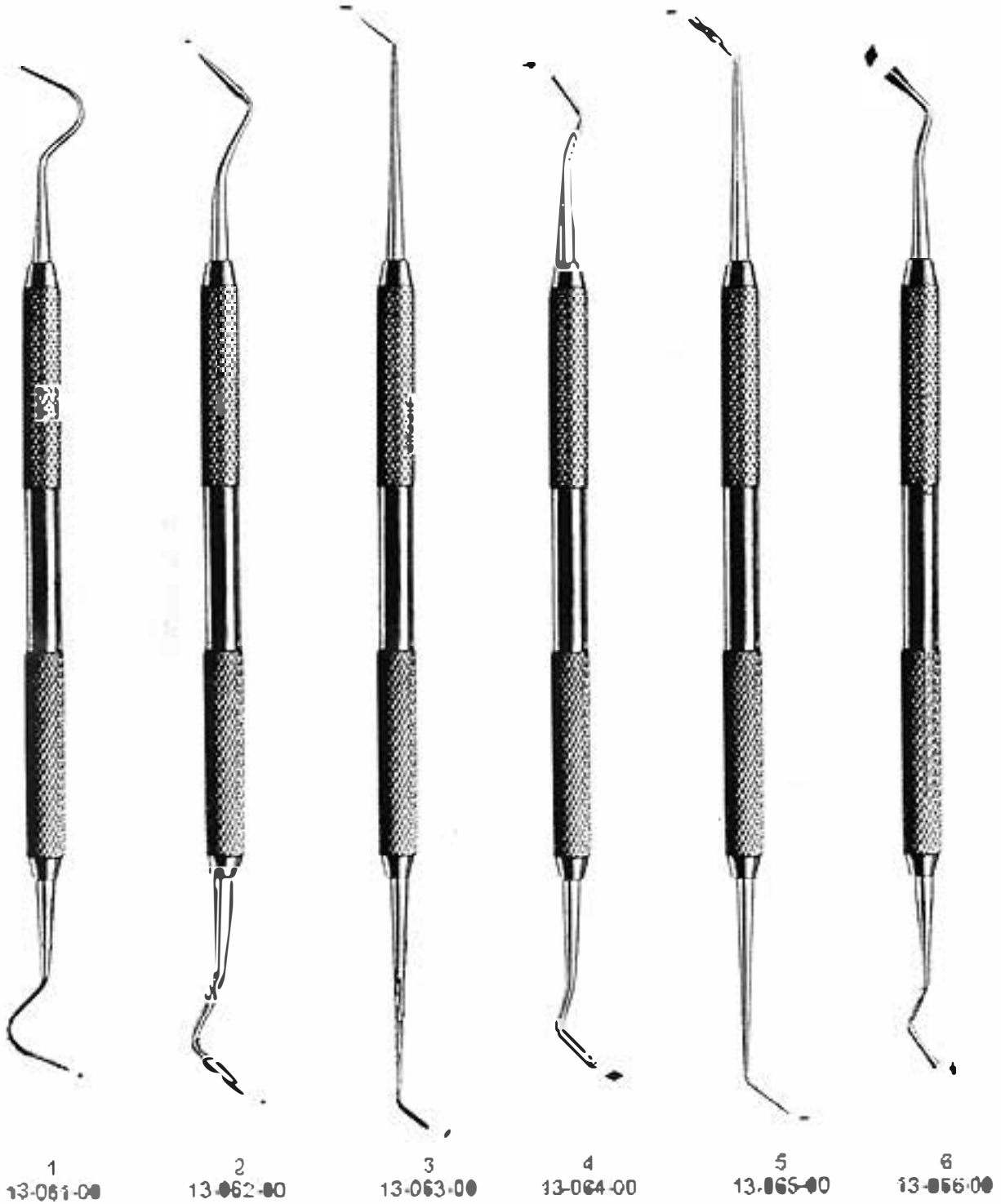

FILLING INSTRUMENTS  
INSTRUMENTS POUR PLOMBAGE  
INSTRUMENTOS PARA OBTURACIONES

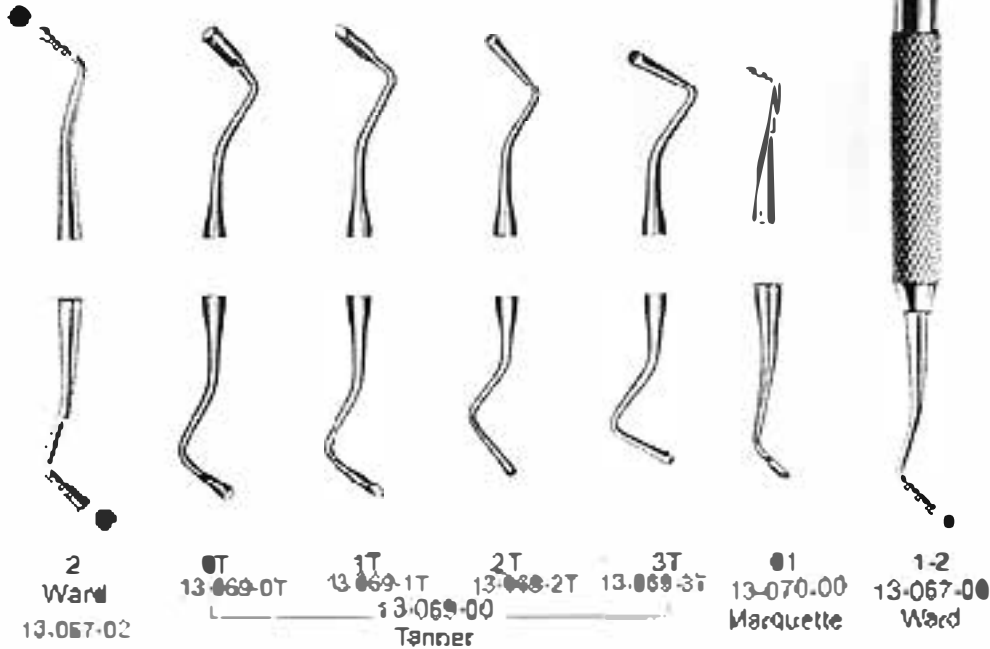
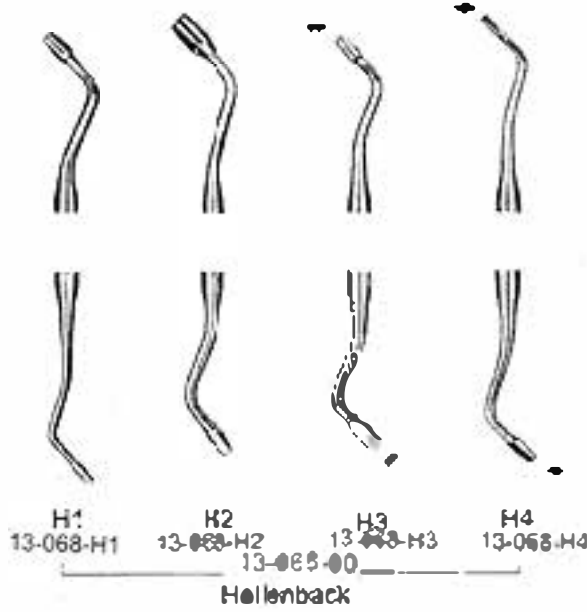

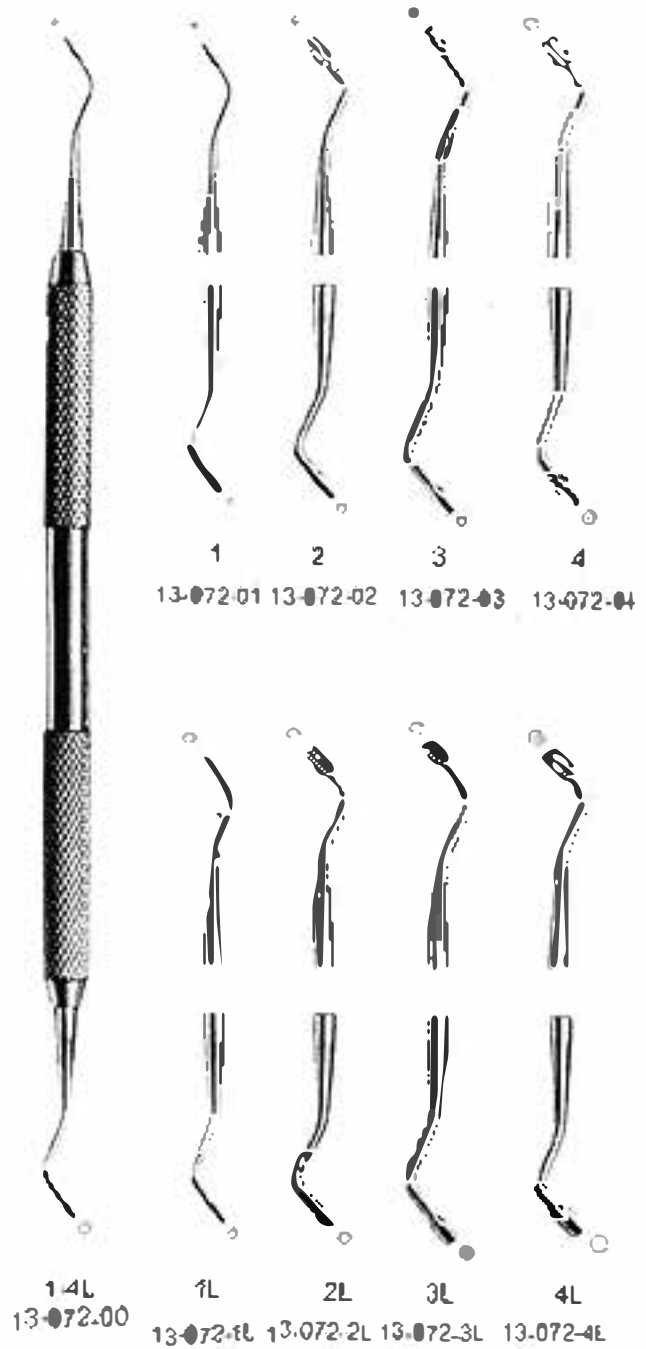
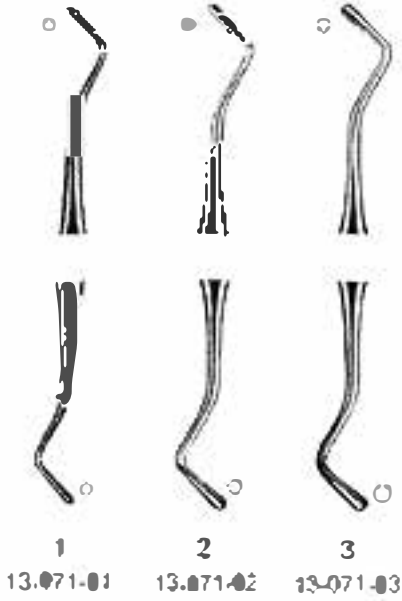

FILLING INSTRUMENTS  
INSTRUMENTS POUR PLOMBAGE  
INSTRUMENTOS PARA OBTURACIONES

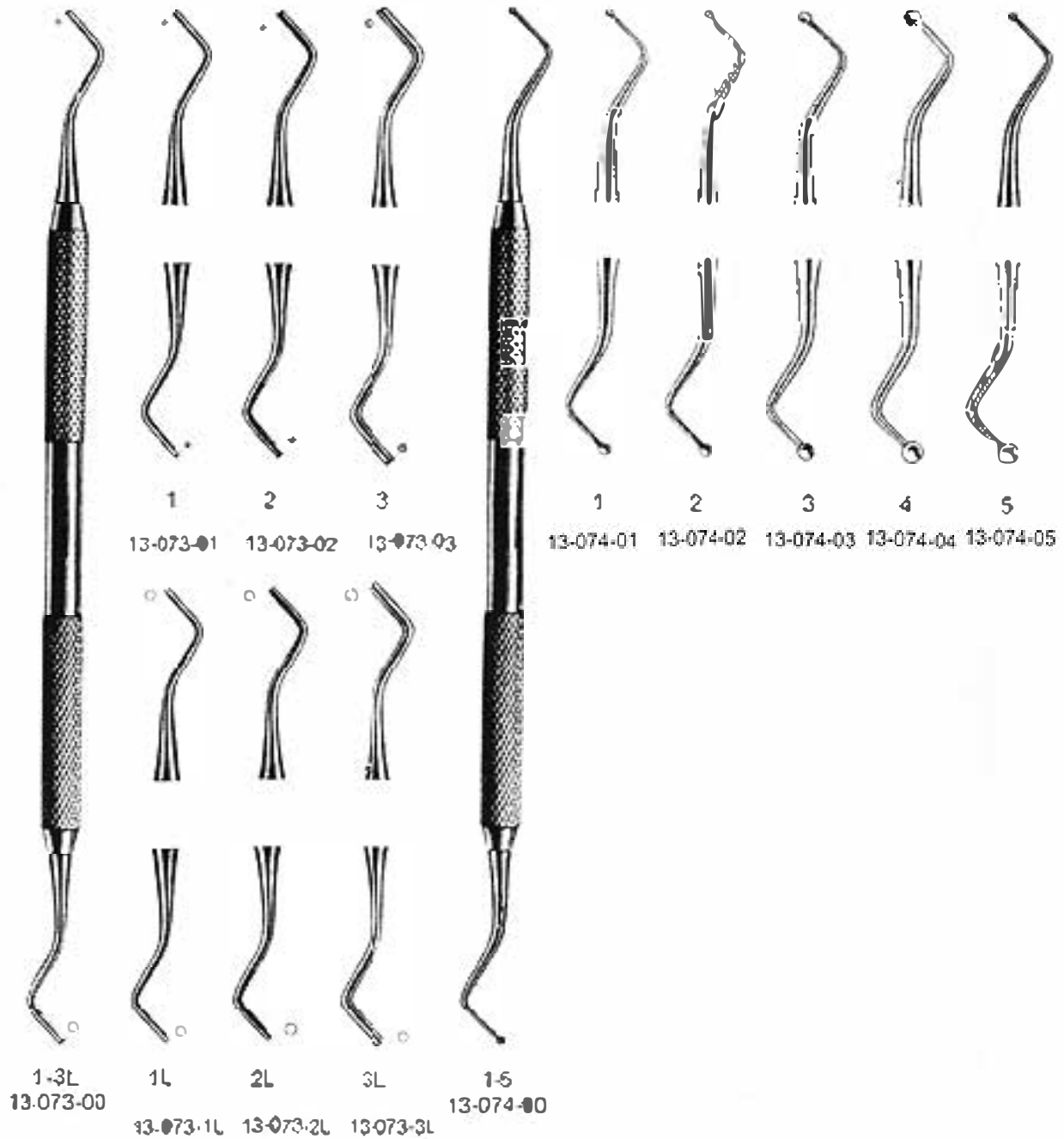



1  
13-075-00



28

13-076-28



29

13-076-29



31

13-076-31



32

13-076-32



33

13-076-33



34

13-076-34

White



1

13-076-01



2

13-076-02



3

13-076-03



5

13-076-05

1-30



25

13-076-25



26

13-076-26



27

13-076-27

White



1  
13-077-00



1  
13-078-00

FILLING INSTRUMENTS  
INSTRUMENTS POUR PLOMBAGE  
INSTRUMENTOS PARA OBTURACIONES



1  
13-079-01



28/29  
13-079-00



27/29  
13-080-00



218  
13-081-00



21  
13-082-00



Discoide  
89/92  
13-083-00



13-084-00



Cleoid-Disoid  
89/90  
13-098-00

Excavator  
17  
13-100-00

Filling  
Instrument  
13-101-00

Filling  
Instrument  
13-102-00

Amalgam  
Condenser  
13-103-00

**NOTE: All other hand instruments are also available in Silicon Grip Handle**

Department

14

BONE RONGEUR FORCEPS  
HOHLMEISSELZANGEN  
PINZAS GUBIAS

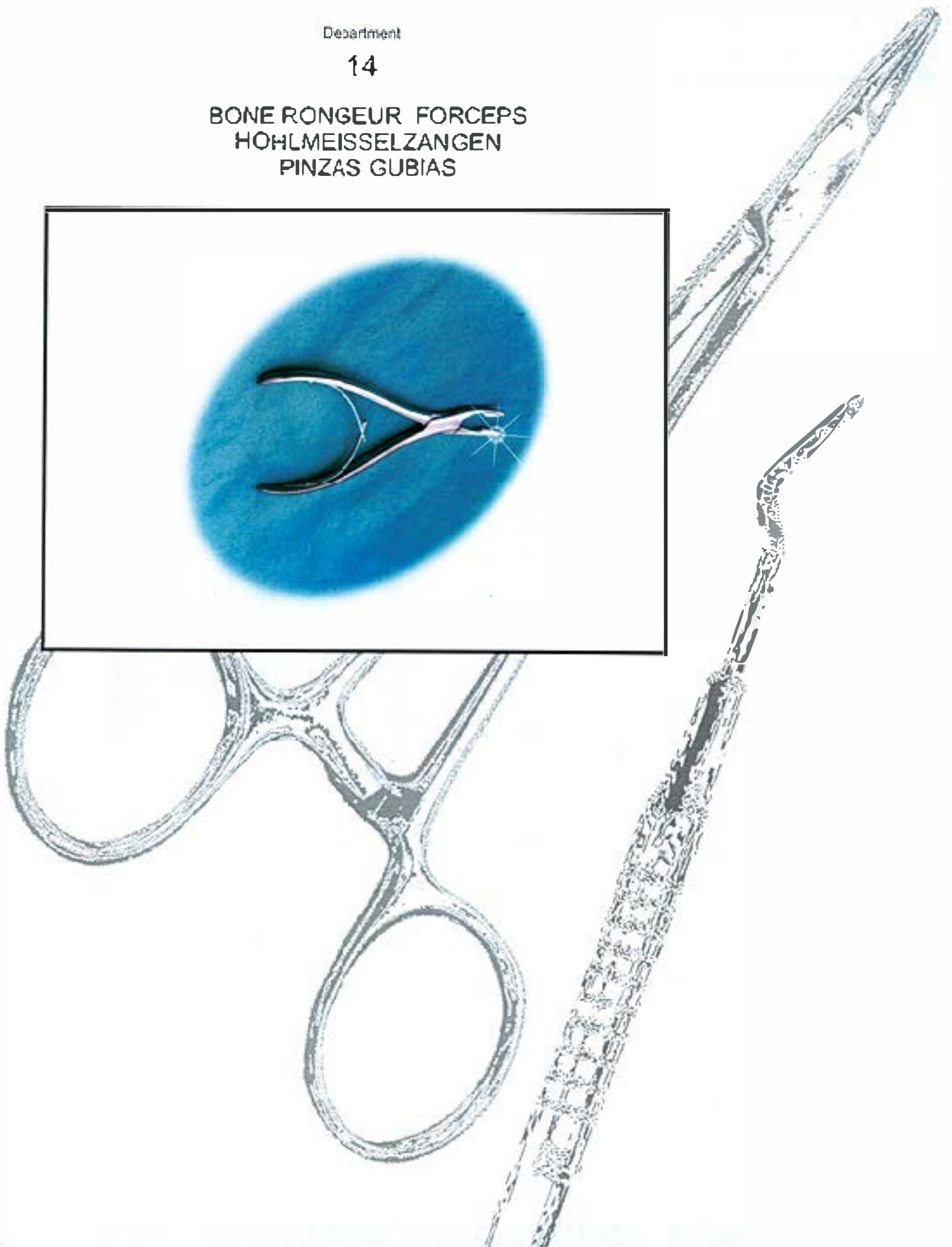
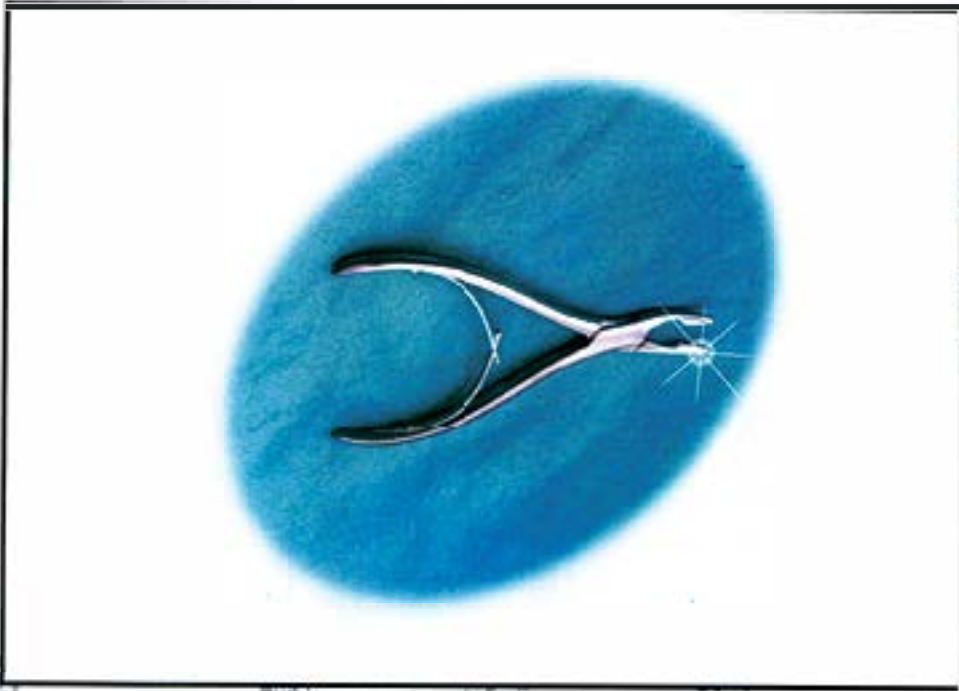



DEPARTMENT NO. 14

---

FROM  
PAGE#

207

TO  
PAGE#

216

INSTRUMENTS CATEGORY

BONE RONGEUR FORCEPS  
HOHLMEISSELZANGEN  
PINZAS GUBIAS



**BONE RONGEUR FORCEPS  
 HOHLMEISSELZANGEN  
 PINZAS GUBIAS**



14-001-17  
 17. Cm  
 Cleveland



14-002-14  
 14. Cm  
 Friedman



14-003-14  
 14. Cm  
 Cleveland



14-004-12  
 12. Cm  
 Mini-Friedman



14-005-18  
 18.5 Cm  
 Hartmann



14-006-16  
 16.5 Cm

Mead



14-007-18  
 18.5 Cm

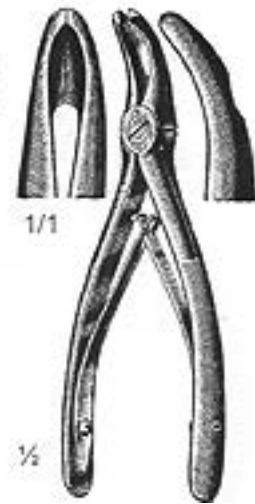

14-008-13  
 13.5 Cm  
 Universal

BONE RONGEUR FORCEPS  
HOHLMEISSELZANGEN  
PINZAS GUBIAS



14-009-15  
15. Cm  
Luer



1/2  
14-010-18  
18. Cm



14-011-15  
15.5 Cm  
Stumenthal

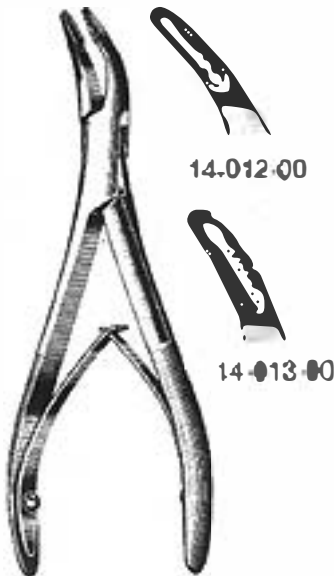

14-012-15  
15. Cm  
Luer



1/2  
14-014-15  
15.5 Cm



14-015-15  
15.5 Cm

Stumenthal



**BONE RONGEUR FORCEPS  
 HOHLMEISSELZANGEN  
 PINZAS GUBIAS**



14-016-00



14-017-00



14-016-16  
 16cm  
 Cleveland-Gardener

14-018-17  
 17cm  
 Cleveland



14-019-15  
 15cm  
 Cleveland

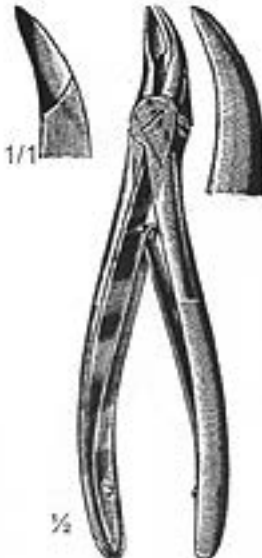

1/1

1/2

14-020-15  
 15cm



1/1

1/2

14-021-18  
 18cm  
 Beyer

BONE RONGEUR FORCEPS  
HÖHLMEISSELZANGEN  
PINZAS GUBIAS



14-072-17  
17cm

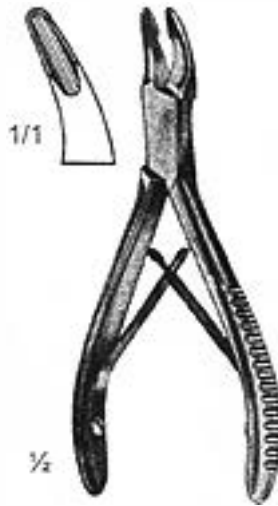

14-073-14  
14cm

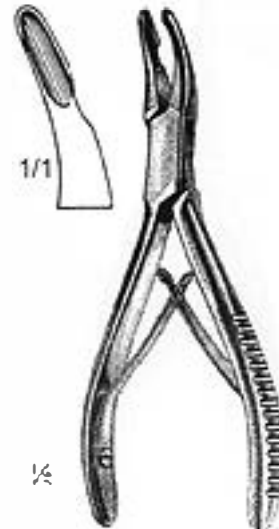

14-074-15  
15cm

Cleveland

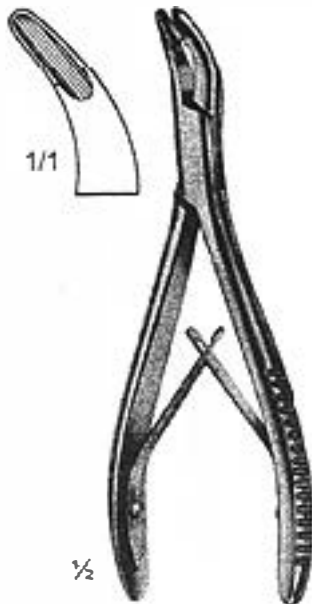

14-075-17  
17cm

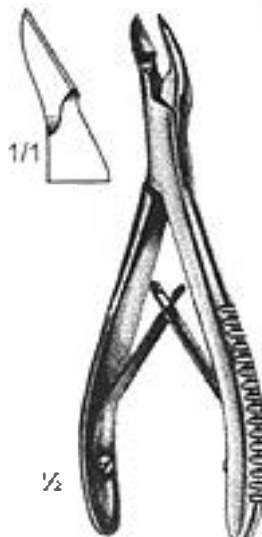

14-076-15  
15cm



14-077-17  
17cm

Cleveland



**BONE RONGEUR FORCEPS**  
**HÖHLMEISSELZANGEN**  
**PINZAS GUBIAS**

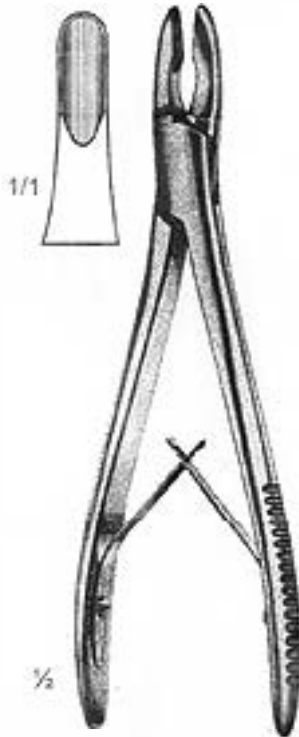

14-078-20  
 20 cm  
 AOS

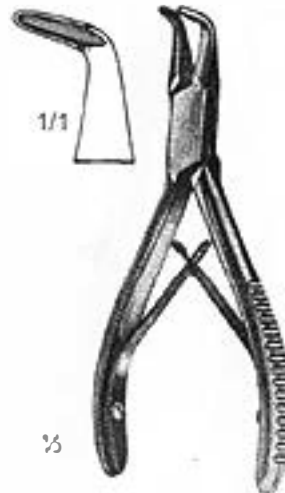

14-079-13  
 13.5 cm

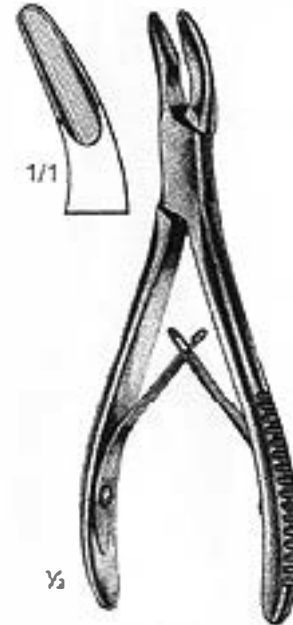

14-080-17  
 17 cm

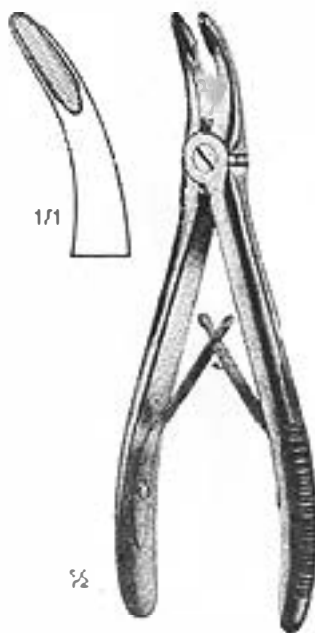

14-081-00

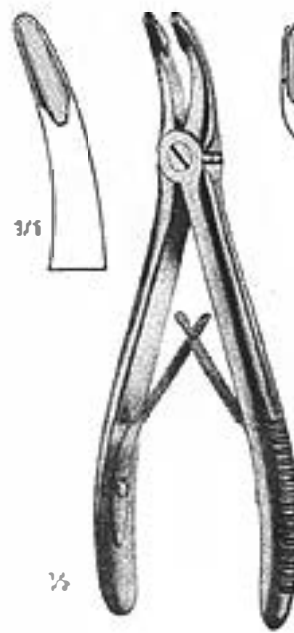

14-082-00

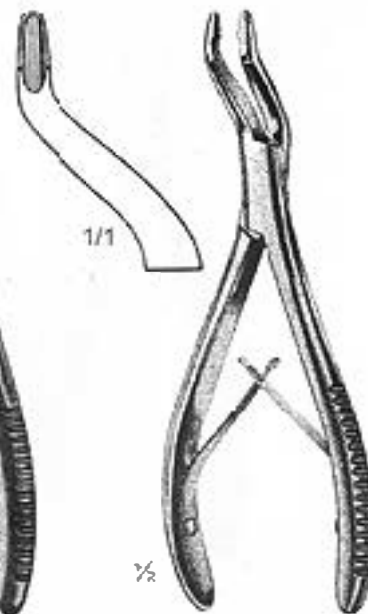

14-083-00

Janssen

BONE RONGEUR FORCEPS  
HOHLMEISSELZANGEN  
PINZAS GUBIAS



14-084-17  
17.5 cm



14-085-14  
14 cm

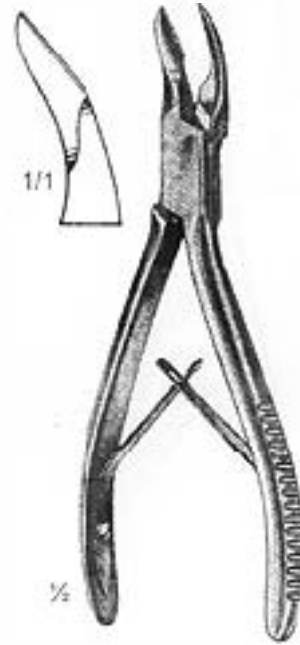

14-082-17  
17.5 cm

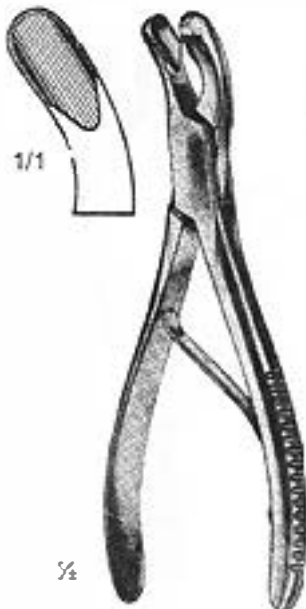

14-087-17  
17 cm  
Luer



14-088-17  
17 cm

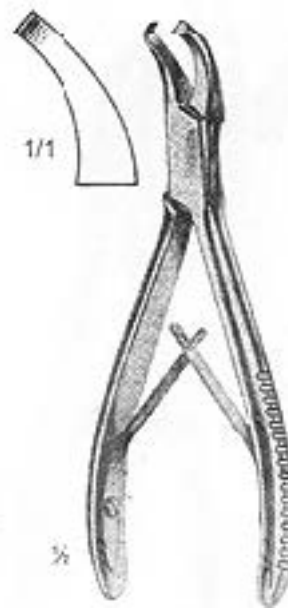

14-085-16  
10 cm

Cleveland-Gardner

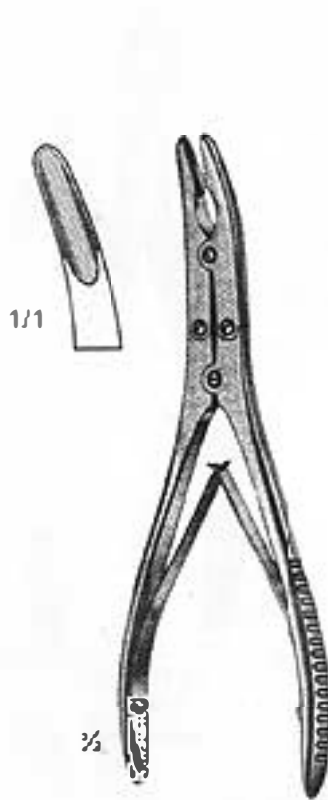

14-090-18  
18 cm  
Ruskin

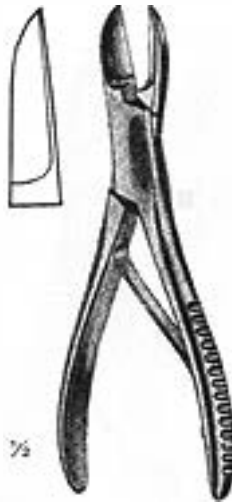

14-091-14  
14 cm  
Liston

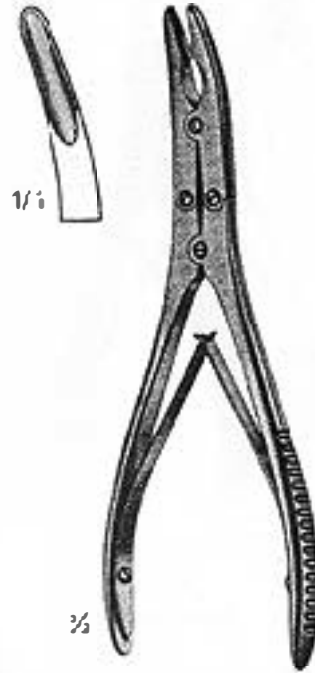

14-092-18  
18 cm  
Bayer

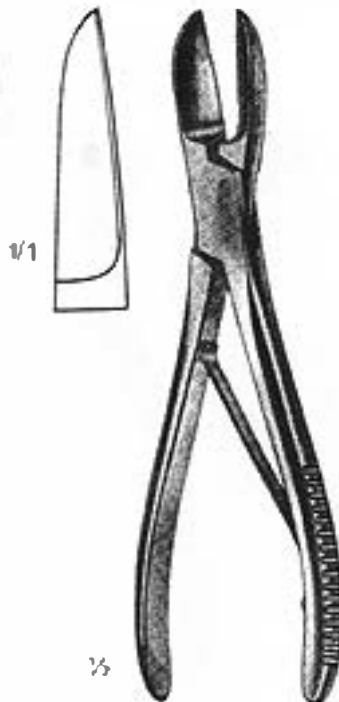

14-093-19  
19 cm  
Liston



BONE RONGEUR FORCEPS  
HOHLMEISSELZANGEN  
PINZAS GUBIAS



14-094-15  
15 cm  
Blumenthal



14-095-16  
16.5 cm  
Blumenthal

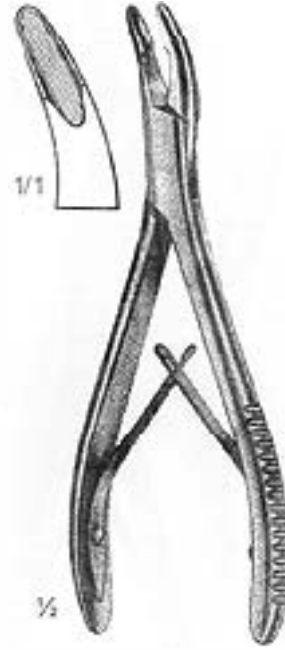

14-098-18  
18 cm  
Karmann

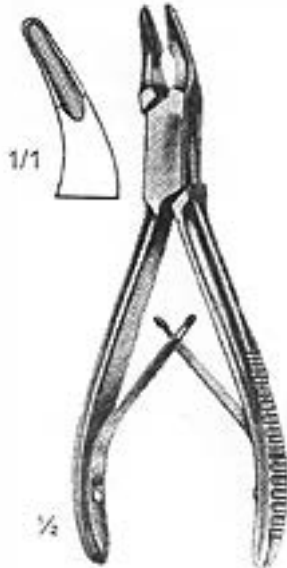

14-097-16  
16 cm

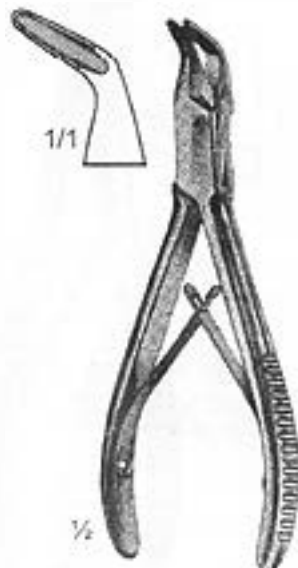

14-095-15  
15 cm

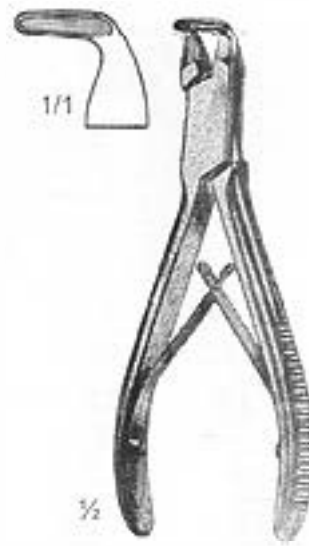

14-099-15  
15 cm

Blumenthal

Department

15

**MOUTH GAGS AND TONGUE RETRACTOR  
MUNDSPERER UND ZUNGENHALTER  
ABRE BOCAS Y ABAJA LENGUA**

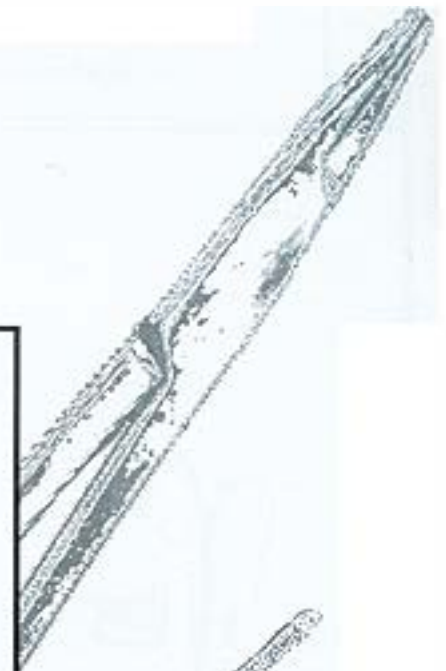
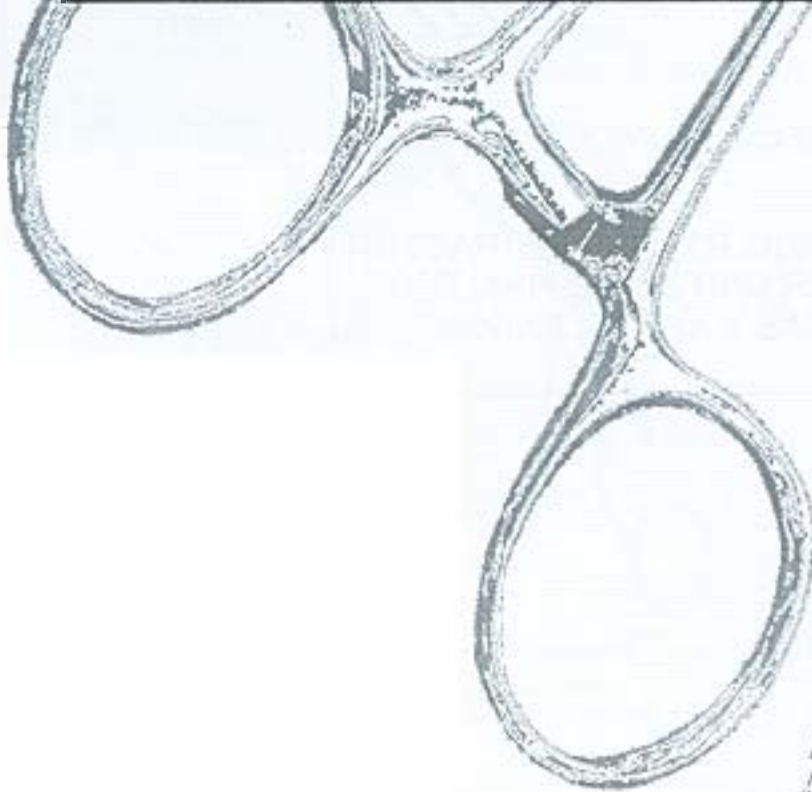
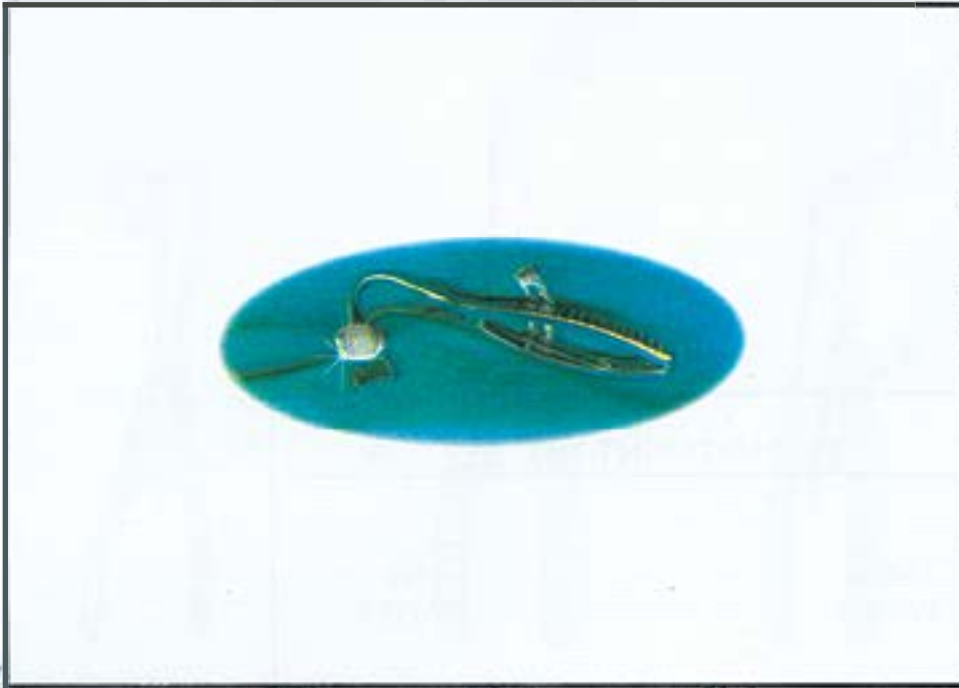

DEPARTMENT NO. 15

FROM  
PAGE#

TO  
PAGE#

217

222

INSTRUMENTS CATEGORY

MOUTH GAGS AND TONGUE RETRACTOR  
MUNDSPERER UND ZUNGENHALTER  
ABRE BOCAS Y ABAJA LENGUA



MOUTH GAGS AND TONGUE RETRACTOR  
MUNDSPERER UND ZUNGENHALTER  
ABRE BOCAS Y ABAJA LENGUA



1/2

15-001-12  
12.5cm  
Denhael



1/2

15-002-18  
18.5cm



1/2

15-003-16  
16cm



1/2

15-004-15  
15.5cm  
Ferguson Ackland

Rose-König



1/2

15-005-12  
12cm  
Doyen-Collin

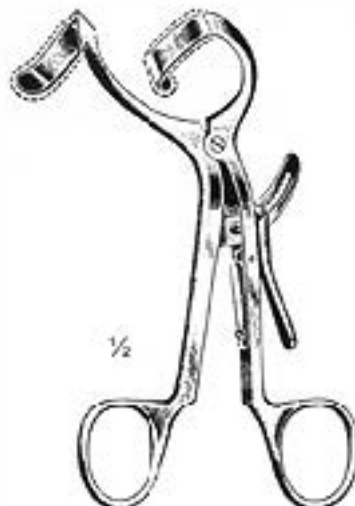

1/2

15-006-14  
14cm  
Coyen-Jansen

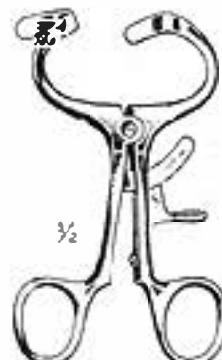

1/2

15-007-10(10 cm)  
15-007-14(14 cm)  
Mol



1/2

15-008-13  
13cm  
Heister

MOUTH GAGS  
MUNDSPERRER  
ABRE-BOCAS

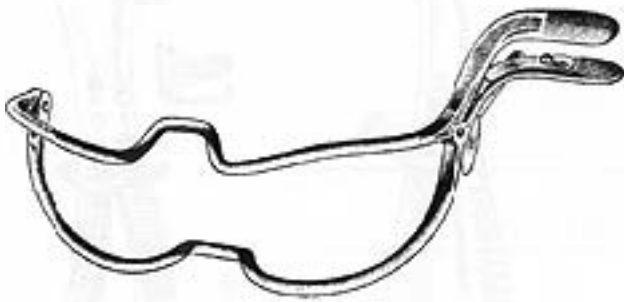
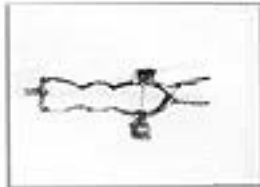

15-050-09(9CM)  
15-050-11(11CM)  
15-050-13(13CM)  
15-050-15(15CM)  
Jennings

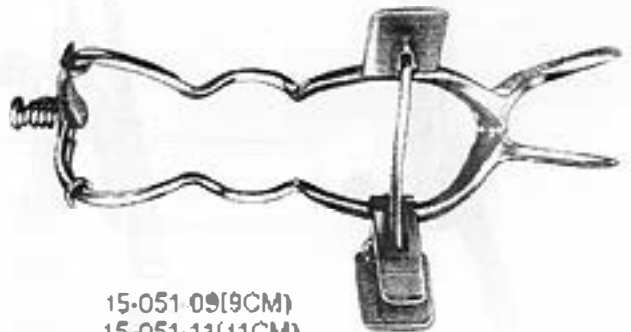

15-051-09(9CM)  
15-051-11(11CM)  
15-051-13(13CM)  
15-051-15(15CM)  
Seibmann-Seiffert  
(Self-retaining)



15-052-11(11CM)  
15-052-13(13CM)  
15-052-15(15CM)



15-053-13(13CM)

Whitehead



MOUTH GAGS  
 MUNDSPERRER  
 ABRE-BOCAS

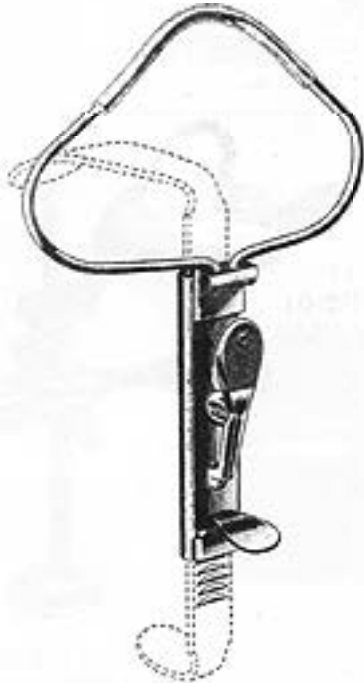

15-054-00



1  
 27x95mm  
 15-055-01



2  
 22x85mm  
 15-055-02



3  
 22x70mm  
 15-055-03

1-3  
 15-055-00  
 Achver



1/2  
 15-056-00

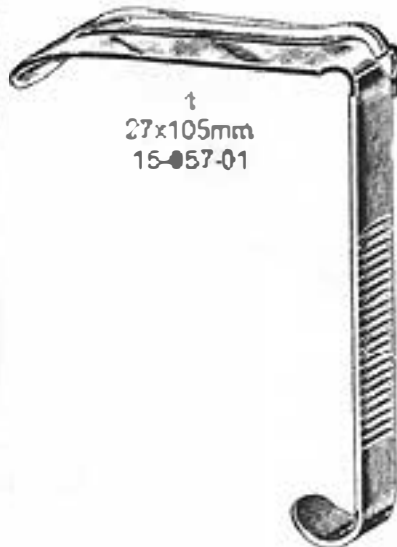

1  
 27x105mm  
 15-057-01



2  
 25x90mm  
 15-057-02

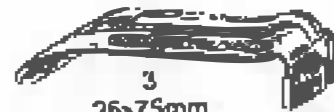

3  
 25x75mm  
 15-057-03

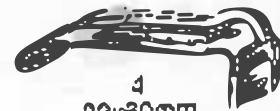

4  
 22x80mm  
 15-057-04



5  
 20x25mm  
 15-057-05

1-5  
 15-057-00  
 Davis-Boyle

TONGUE DEPRESSOR  
ZUNGEN-UND WATTEROLLENHALTER  
ABAISSE-LANGUE AVEC ABAISSE-TAMPON



3  
15-108-03  
For Adults



1  
15-108-02  
For Adults

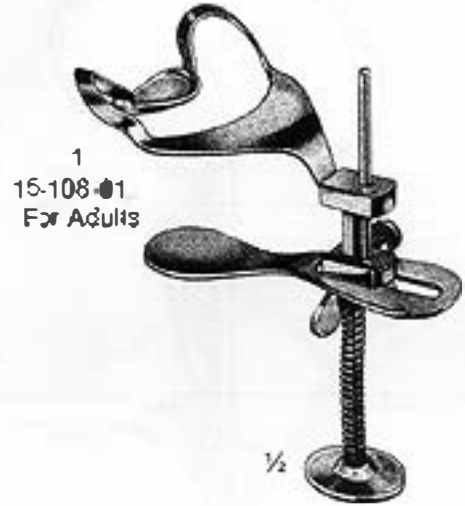

1  
15-108-01  
For Adults

1/2  
15-109-00  
Automatic



1  
15-110-01  
For Children



2  
15-110-02  
For Children



3  
15-110-03  
For Children



1/1  
15-111-00  
Tongue Ejectors(metal)

Department

16

DISSECTING SCISSORS  
PRÄPARIERSCHEREN  
TIJERAS PARA PREPARACIONES

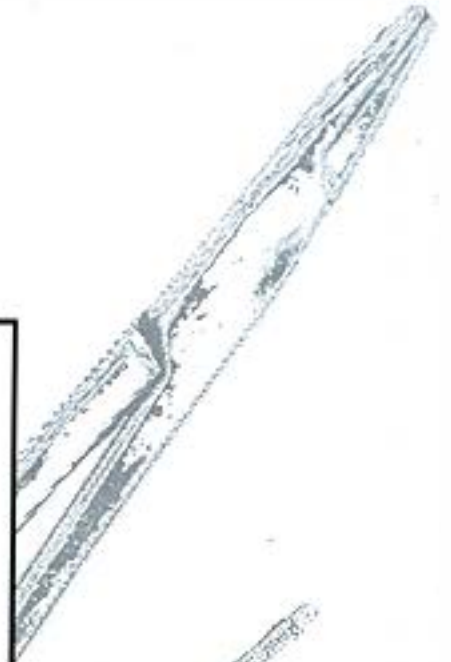



DEPARTMENT NO. 16

FROM  
PAGE#

223

TO  
PAGE#

234

INSTRUMENTS CATEGORY

DISSECTING SCISSORS  
PRAPARIERSCHEREN  
TIJERAS PARA PREPARACIONES



16.001-14  
14.5 cm



16.002-14  
14.5 cm



16.003-14  
14.5 cm

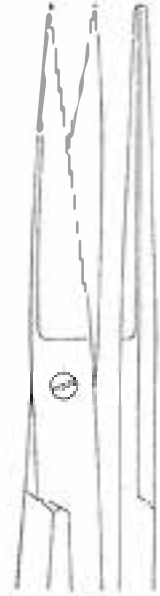

16.004-14  
14.5 cm

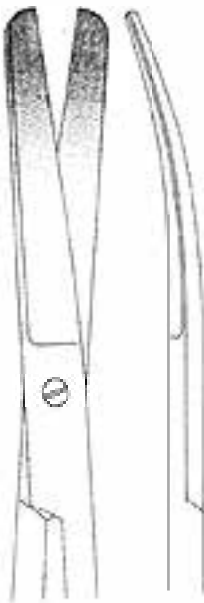

16.005-14  
14.5 cm



16.006-14  
14.5 cm

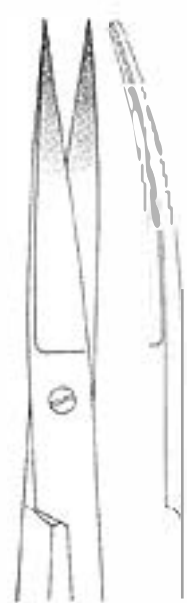

OPERATING SCISSORS  
CHIRURGISCHE SCHEREN  
TIJERAS PARA CIRUGIA

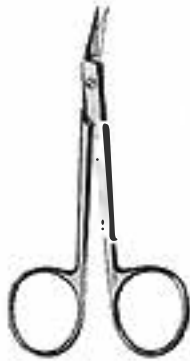
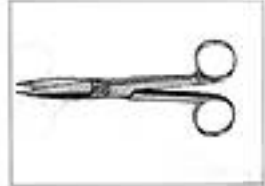

16-010-09  
9.5 cm  
O'Brien



16-009-12  
12.5 cm  
Northcott



16-008-08  
9 cm  
Stanton



16-007-09 (9 cm)  
16-007-10 (10.5 cm)  
16-007-13 (13 cm)  
Spencer

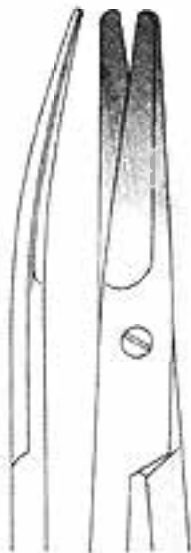

18-013-14

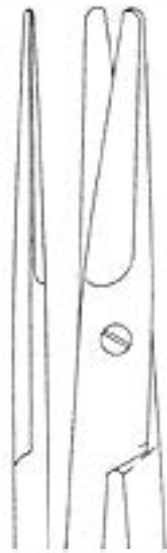

18-012-14



18-012-14  
18-013-14  
14.5 cm  
Mayo



18-011-11  
11.5 cm



DISSECTING SCISSORS  
 PRAPARIERSCHEREN  
 TIJERAS PARA PREPARACIONES

16

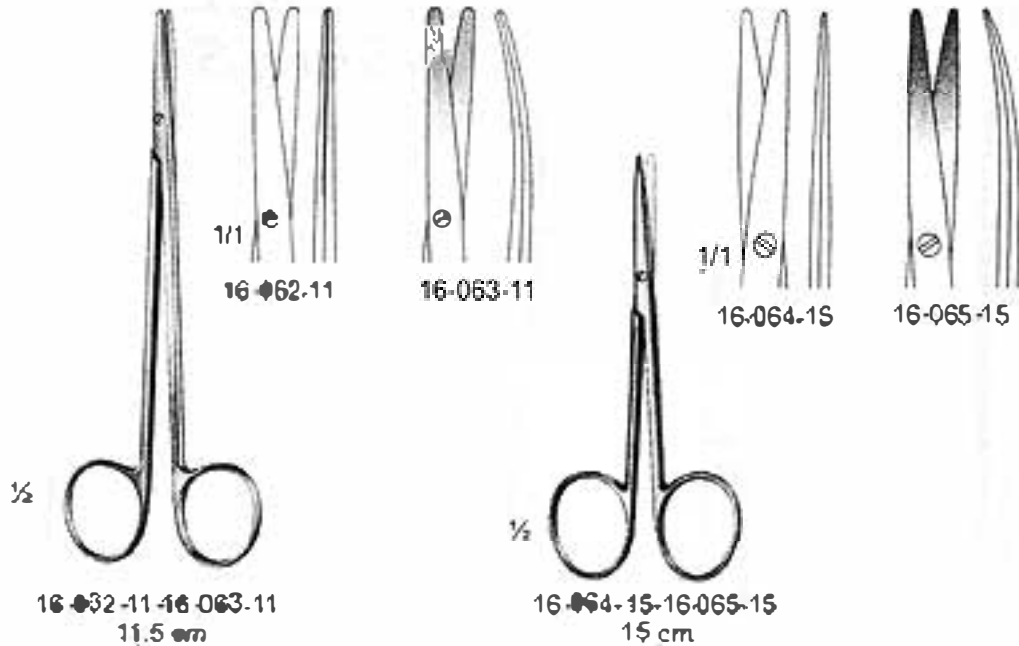

Metzenbaum

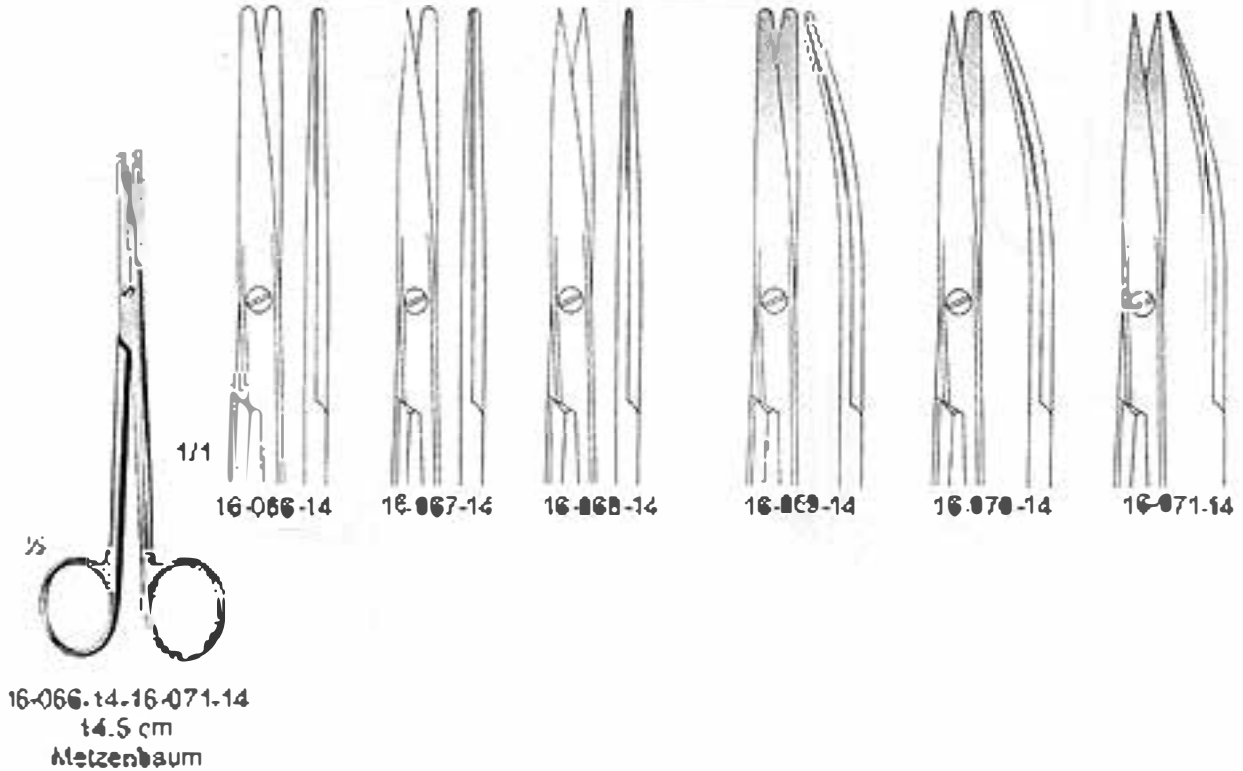



## TUNGSTEN CARBIDE INSERTS



16-121-13 str  
16-122-13 cur  
13 cm  
Goldmann-Fox



16-125-11  
11 cm  
La Grange

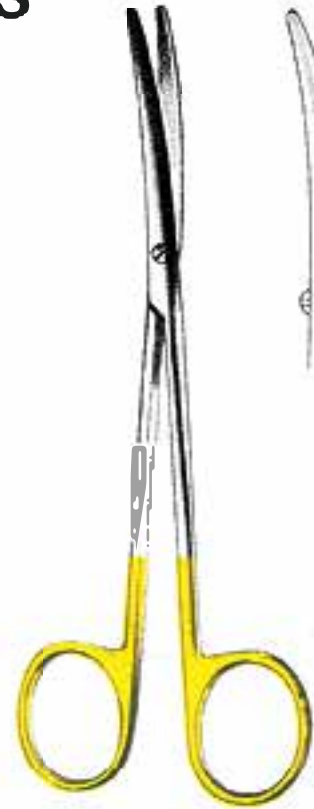

16-128-14 str  
16-129-14 cur  
14.5 cm  
Metzenbaum



16-123-16 str  
16-124-16 cur  
16 cm  
Kely

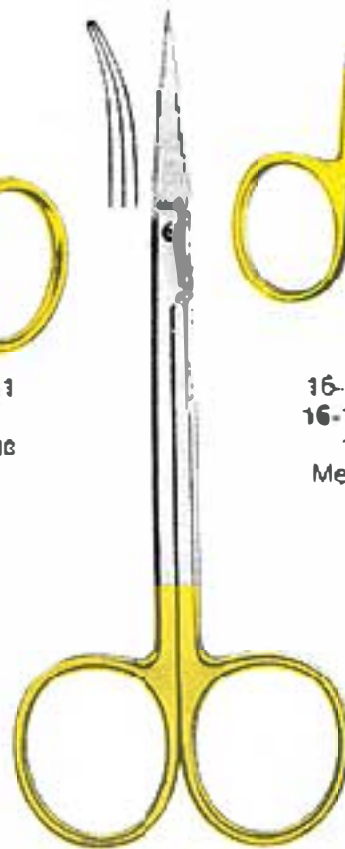

16-126-11 str  
16-127-11 cur  
11.5 cm

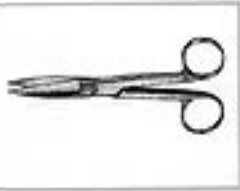

GUM SCISSORS  
ZAHNFLEISCHSCHEREN  
TIJERAS PARA ENCIAS



16-178-11-13-178-11  
11.5 cm

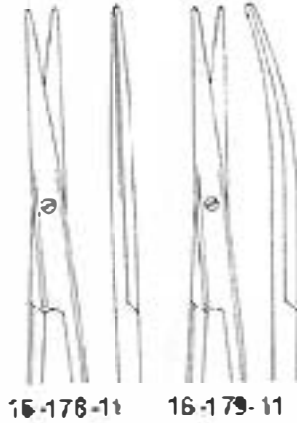

16-178-11 16-179-11

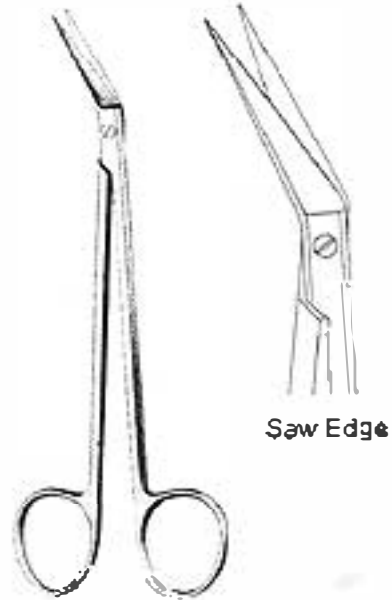

Saw Edge

16-180-16  
16 cm  
Lockin



16-181-17-16-182-17  
17 cm  
Lockin



16-181-17

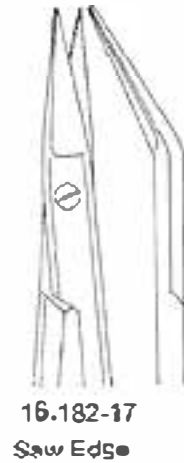

16-182-17  
Saw Edge



Saw Edge

16-183-16  
16 cm  
Lockin

# FINE OPERATING SCISSORS FEINE CHIRURGISCHE SCHERE TIJERAS FINAS PARA CIRUGIA



16-244-14.16-245-14  
14 cm  
Sarvenero

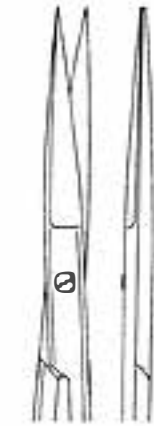

16-244-14



16-245-14



16-246-14.16-247-14  
14 cm  
Joseph

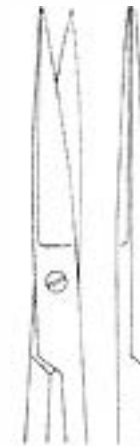

16-246-14



16-247-14

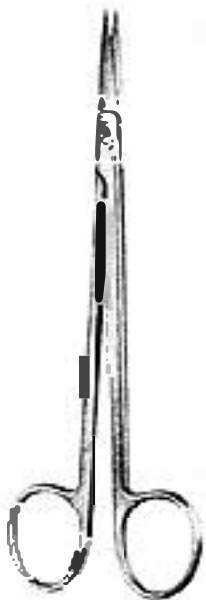

16-248-16.16-249-18  
16 cm  
18 cm  
Kelly



16-248-16



16-248-18

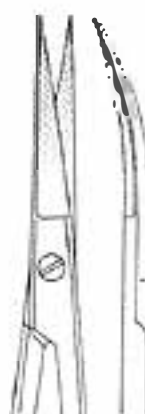

16-249-16



16-249-18

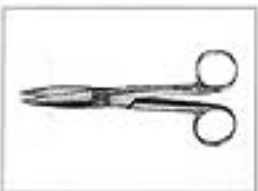

GUM SCISSORS  
CISEAUX A GENCIVES  
TIJERAS PARA RNCIAS

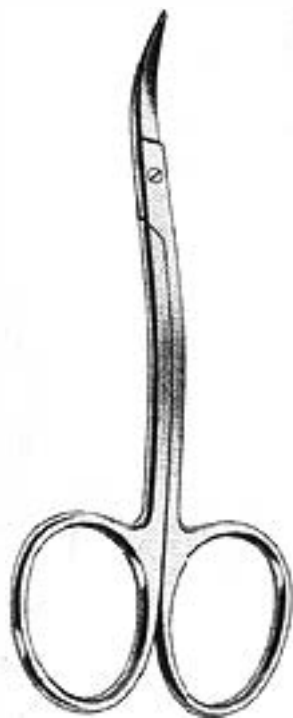

18-300-11  
11.5 cm  
La Garge

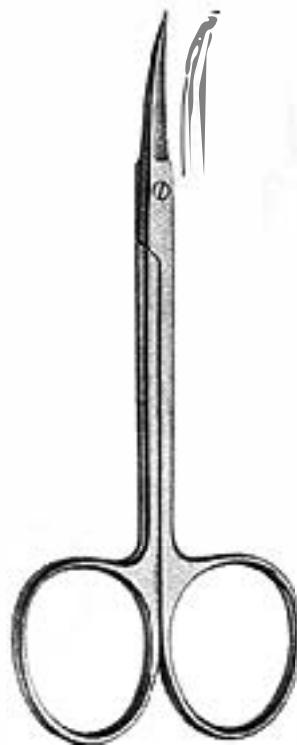

18-301-11  
11.5 cm  
Ins

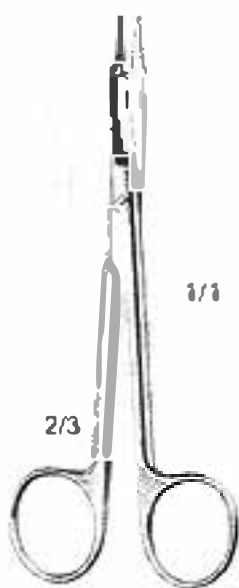

2/3

1/1

1  
18-302-13  
13 cm

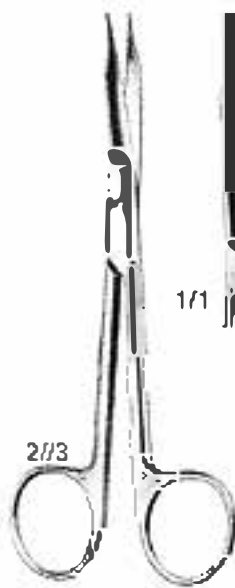

2/3

1/1

2  
18-303-13  
13 cm

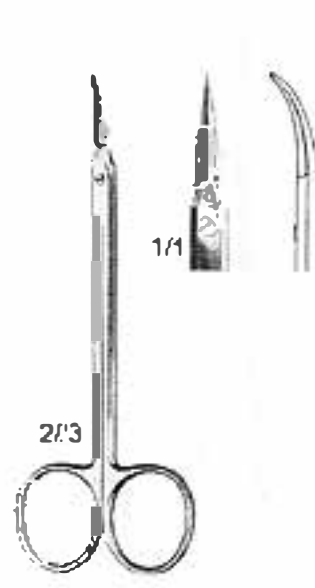
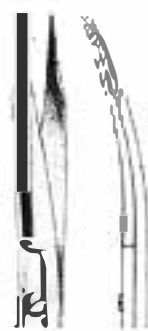

2/3

1/1

18-304-11  
11 1/2 cm





GUM SCISSORS  
ZAHNFLEISCH SCHEREN  
TIJERAS PARA ENCIAS

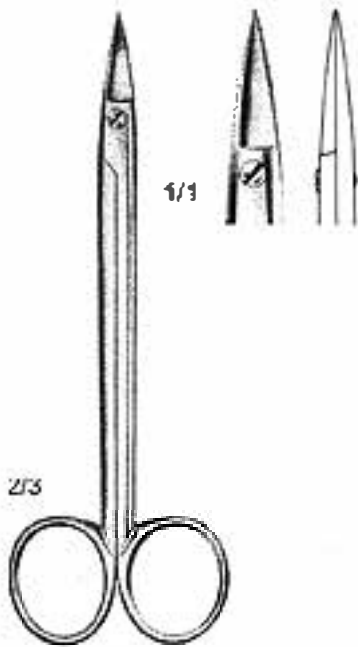

1  
16-305-12  
12.5 cm

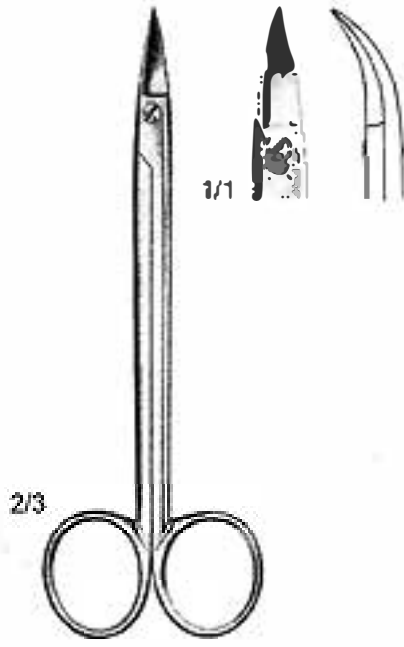

2  
16-306-12  
12.5 cm

Quinby

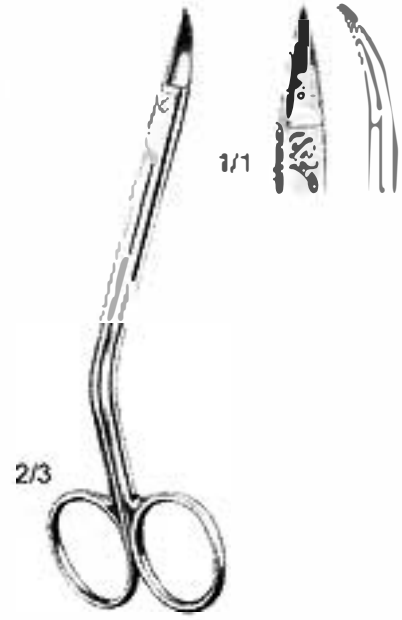

16-307-12  
12 cm  
Neumann



1-4  
16-308-11  
11 cm  
Ris



16-309-11  
11 cm

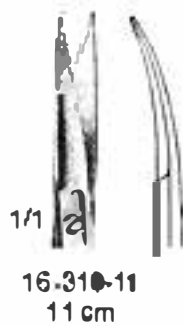

16-310-11  
11 cm



16-311-11  
11 cm



16-312-11  
11 cm



**GUM SCISSORS  
ZAHFLEISCH SCHEREN  
TIJERAS PARA ENCIAS**

16



16-313-12  
12 cm  
NoYes



16-314-11  
11 cm



16-315-11  
11 cm

Westcott



16-316-00



16-317-15  
15 cm



16-318-15  
15 cm



16-319-15  
15 cm  
Reil  
Saw Edge

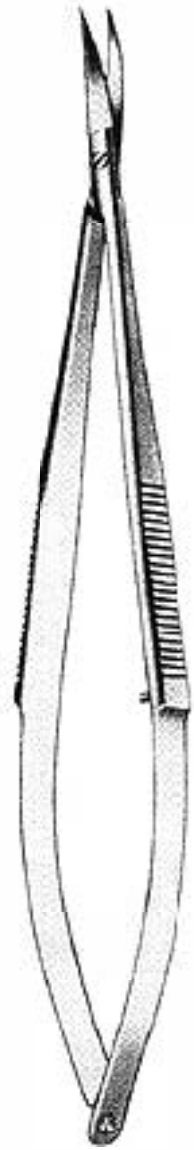

16-320-15  
15 cm  
Castroviejo

CROWN SCISSORS - CISEAUX A  
KRONEN SCHEREN  
TIJERAS PARA CORONOS

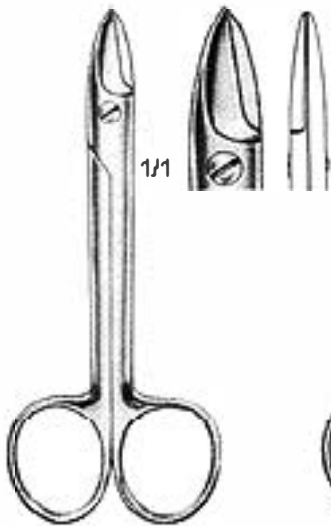
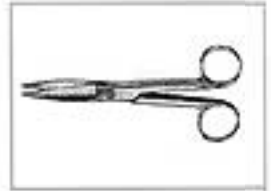

16-365-10  
10.5 cm  
Beebee

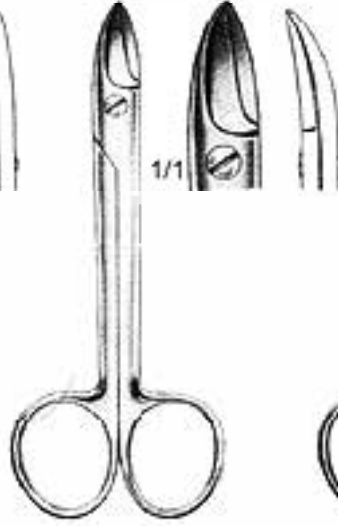

16-366-10  
10.5 cm  
Beebee

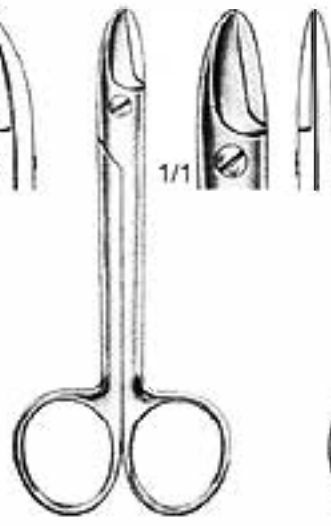

16-367-10  
10.5 cm  
Beebee

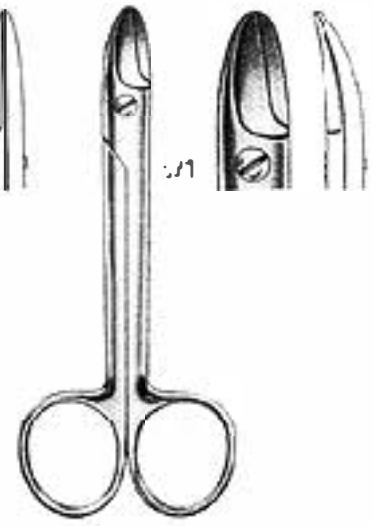

16-368-10  
10.5 cm  
Beebee



16-369-10  
10.5 cm

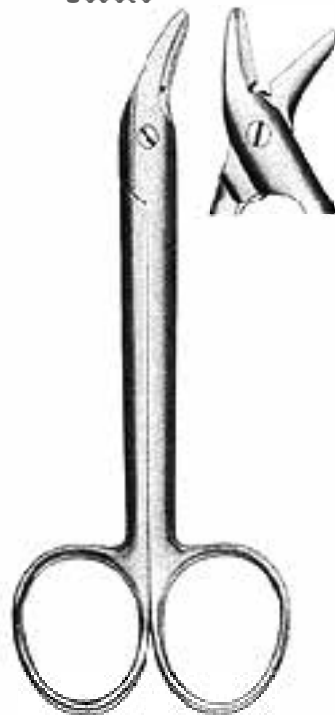

16-370-12  
12 cm  
Universal

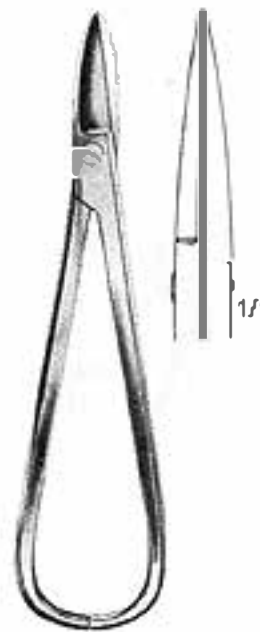

16-371-117  
17 cm



16-372-117  
17 cm

Department

17

TISSUE RETRACTORS  
WEICHTEILHAKEN  
SEPARADORES

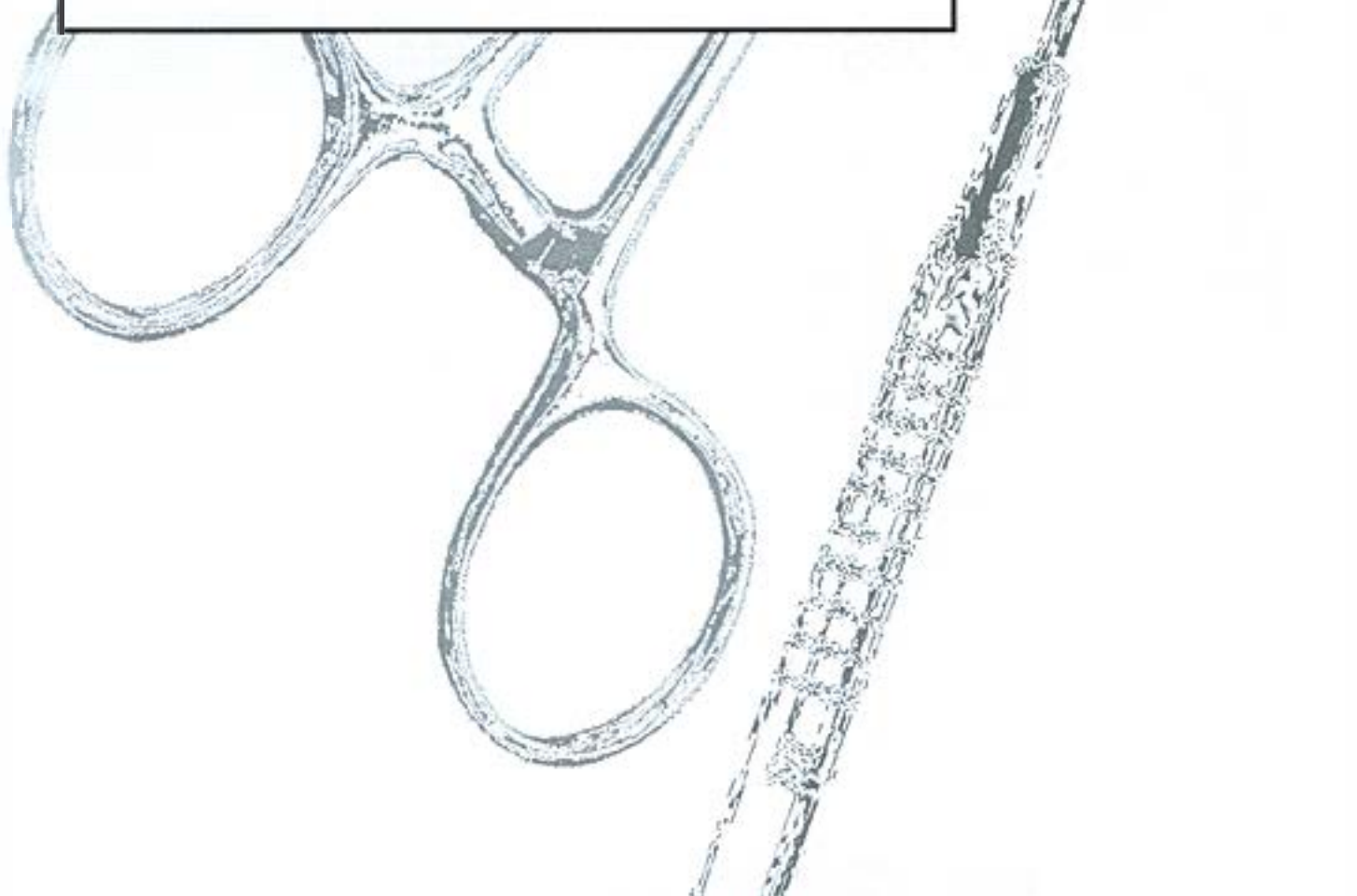
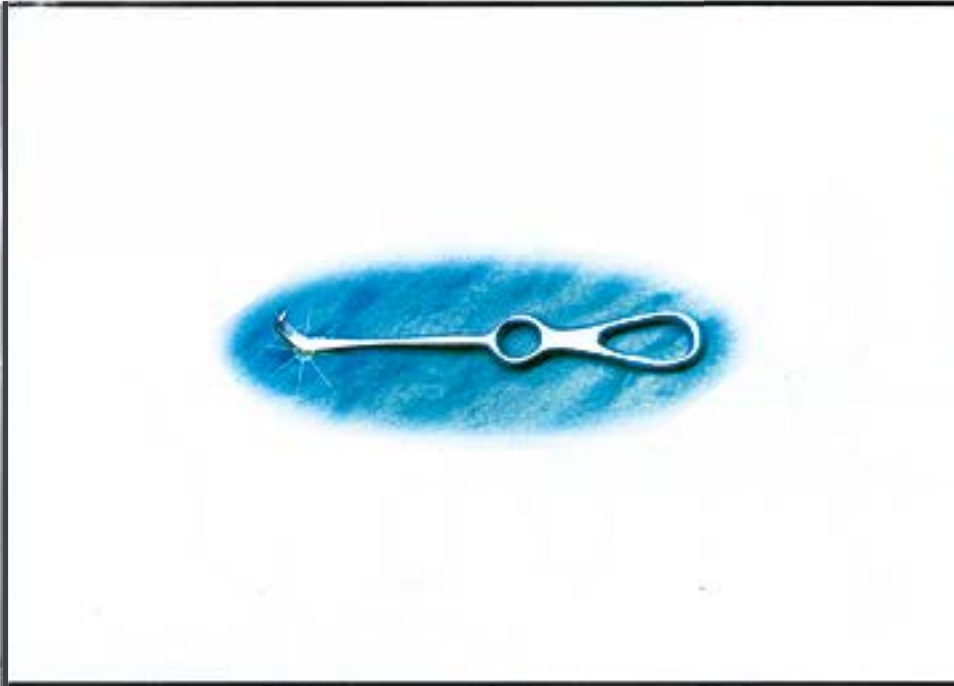

DEPARTMENT NO. 17

---

FROM  
PAGE#

235

TO  
PAGE#

244

INSTRUMENTS CATEGORY

TISSUE RETRACTORS  
WEICHTEILHAKEN  
SEPARADORES



**PETRACTORS - MOUTH GAGS**  
**ECARTEURS - OUVRE - BOUCHES**  
**SEPARADORES - ABRE - BOCAS**

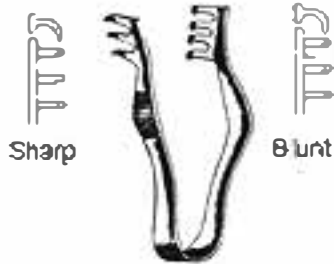
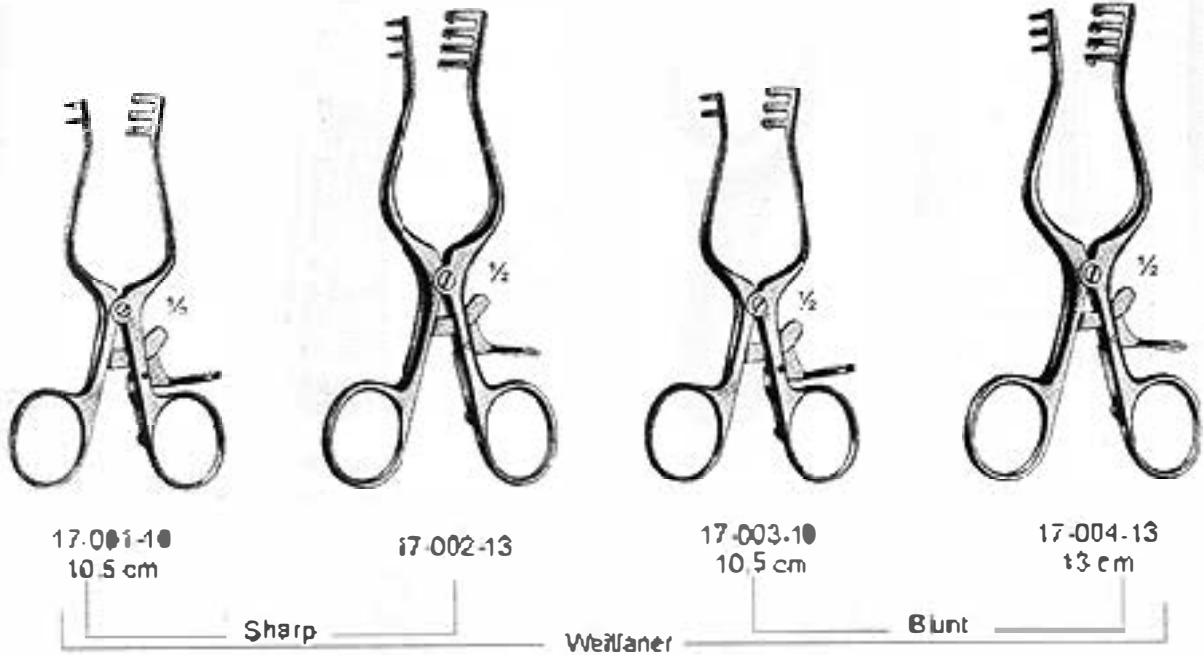

17-005-07(Sharp)  
 17-006-07(Blunt)  
 7 cm  
 Finsen

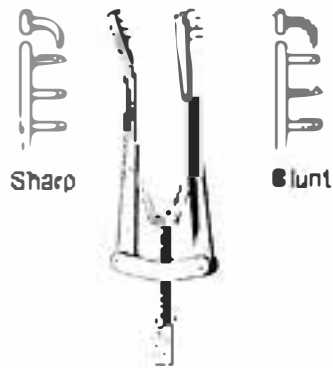

17-007-10(Sharp)  
 17-008-10(Blunt)  
 10 cm  
 All

RETRACTORS - MOUTH GAGS  
 ECARTEURS - OUVRE-BOUCHES  
 SEPARADORES - ABRE-BOCAS

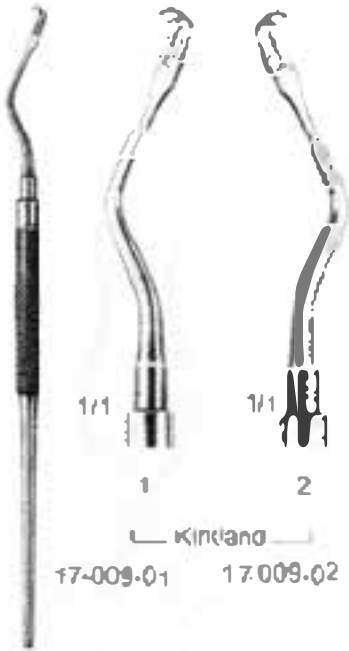

Kindland  
 17-009-01    17-009-02

17-009-18  
 18 cm



17-010-11  
 11 cm  
 Simplex



17-01100  
 Minnesota



17-011-14 14 cm  
 17-011-15 15 cm  
 Wieder



17-012-13  
 13 cm  
 Farabeuf



17-013-12 (12 cm)    17-014-14 (14 cm)  
 17-013-14 (14 cm)    17-014-16 (16 cm)  
 17-013-16 (16 cm)    17-014-18 (18 cm)

Stenberg



17-015-00



17-016-00

Brunings



17-017-00



17-018-00

Luniatzschek

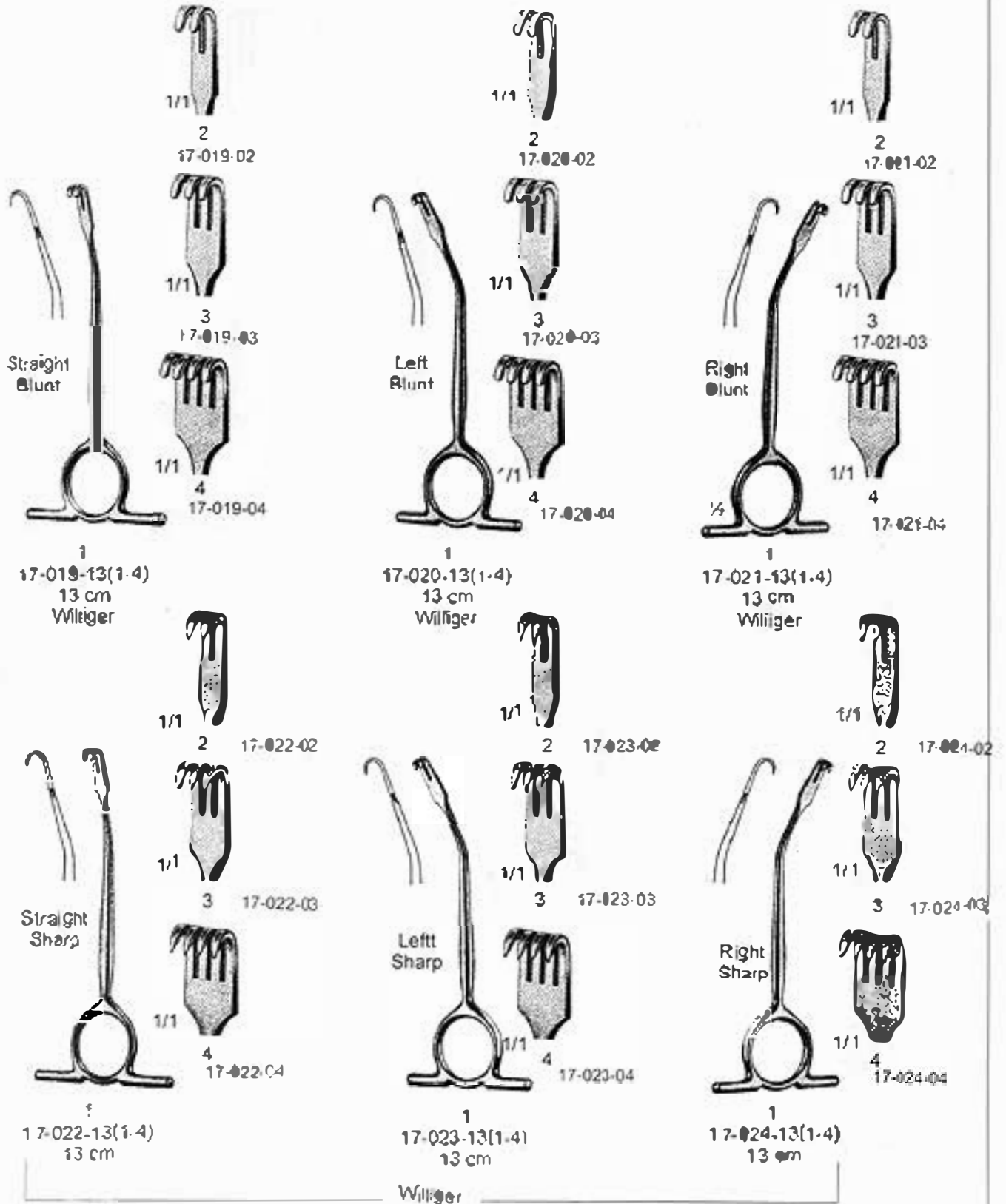



RETRACTORS  
ECARTEURS  
SEPARADORES



17-025-16  
16 cm



17-027-16  
16 cm  
Sharp



2  
17-028-00  
Blunt

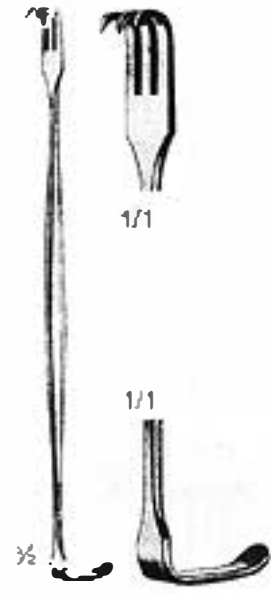

17-029-00  
Senn-Kuebler



1  
17-030-01  
Middeldorff



17-030-02



17-030-03



17-031-21  
21 cm



17-032-21  
21 cm

Kocher



17-032-19  
19 cm  
Wassmann



17-033-22(1-5)  
22 cm  
Langensack



17-033-02



17-033-03

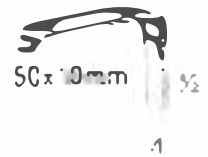

17-033-04



17-033-05



1.5  
 17-034-21  
 21 cm  
 Langenbeck

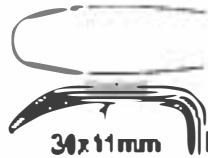

1  
 30x11mm  
 17-034-01



2  
 30x14mm  
 17-034-02

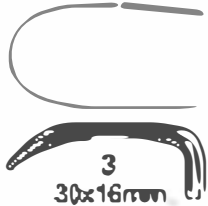

3  
 30x16mm  
 17-034-03

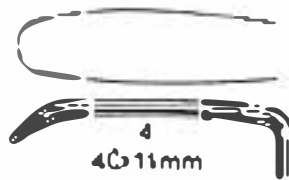

4  
 40x11mm  
 17-034-04

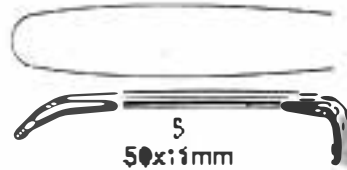

5  
 50x11mm  
 17-034-05



1/2



1  
 17-035-01



2  
 17-035-02



3  
 17-035-03



4  
 17-035-04



1/1



5  
 17-035-05



6  
 17-035-06



7  
 17-035-07



8  
 17-035-08



1/1

Blunt

SOFT TISSUE RETRACTORS  
WEICHTEILHAKEN  
SEPARADORES

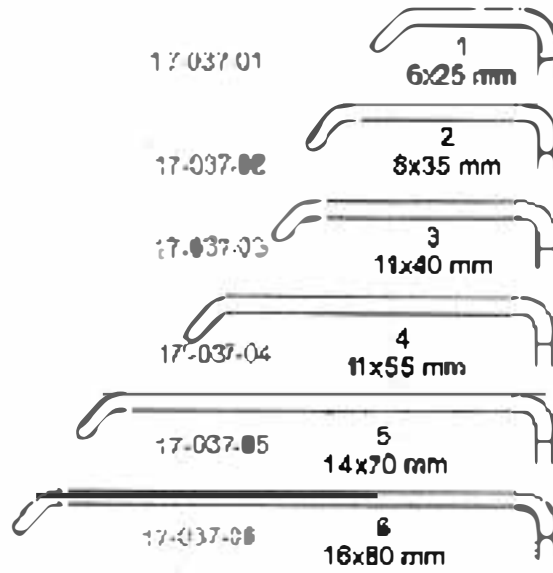
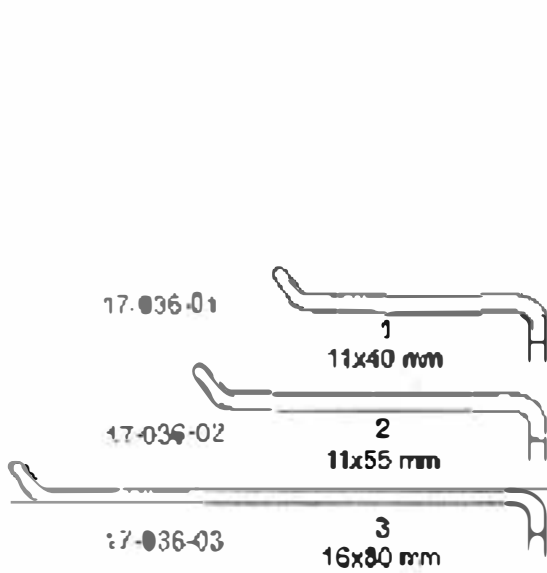
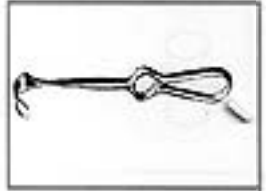

1-3  
17-036-22  
22 cm  
Obwegeser



1-6  
17-037-21  
21.5 cm  
Obwegeser  
(Kocher-Langenbeck)



SOFT TISSUE RETRACTORS  
 WEICHTEILHAKEN  
 SEPARADORES

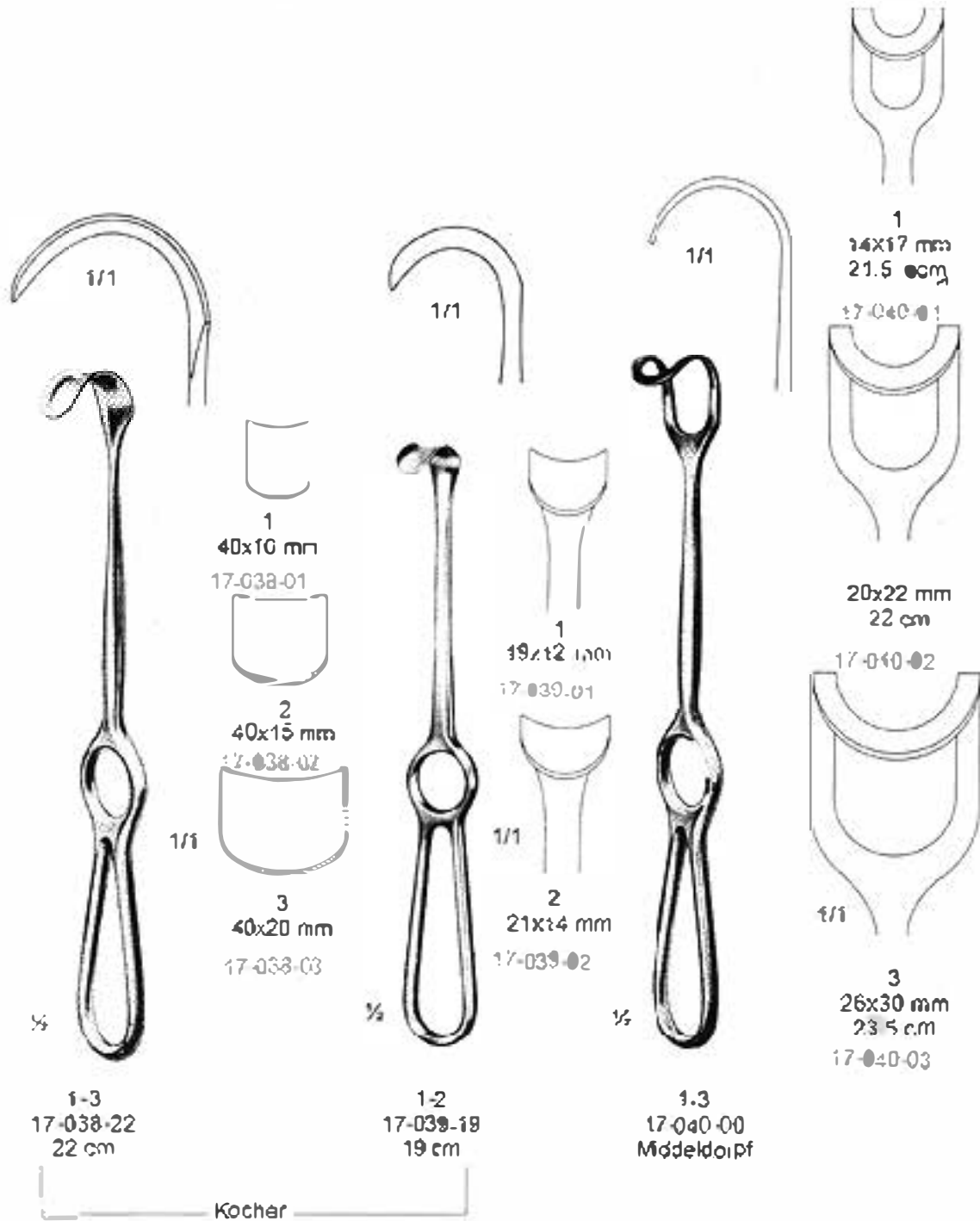

TISSUE RETRACTORS  
WEICHTELHAKEN  
SEPARADORES

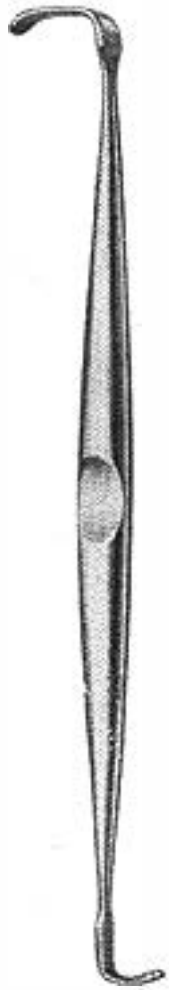
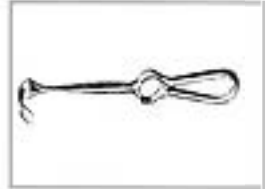

17-041-00  
8x4 mm x 15x5 mm  
Ragnell - Davis

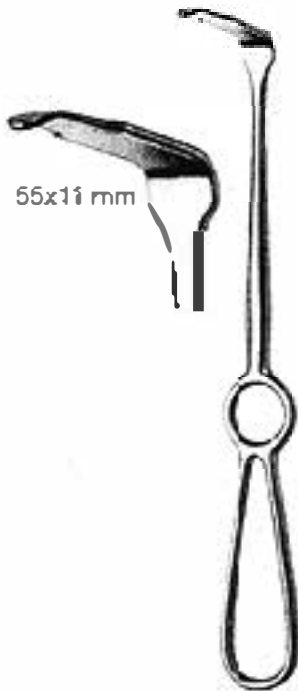

1-2  
17-042-22  
22cm  
Miller



1-2  
17-043-00  
Meyerding



17-044-00  
Wassmund



1  
28x8 mm  
17-045-01



2  
35x11 mm  
17-045-02

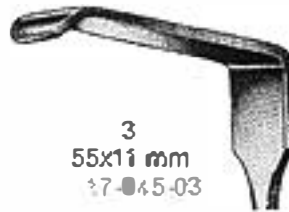

3  
55x11 mm  
17-045-03



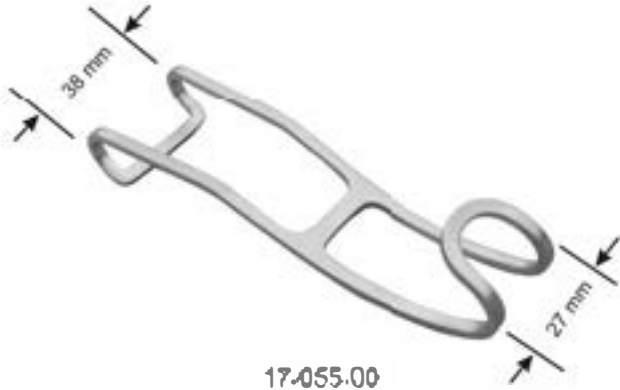

17-055-00  
38 x 27 mm

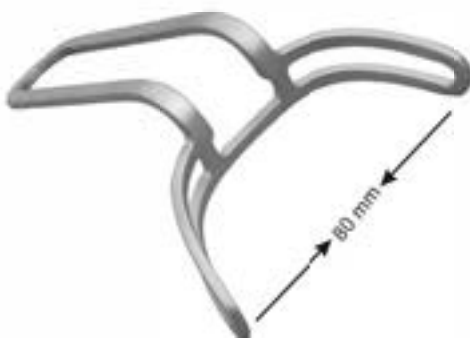

17-056-00  
14 cm



Frazier (Fergusson)

- 17-057-06 Chair 6 mm
- 17-058-08 Chair 8 mm
- 17-059-10 Chair 10 mm
- 17-060-12 Chair 12 mm

18 cm

©spannont

18

ARTERY FORCEPS  
ARTERENKLEMMEN  
PINZAS HEMOSTATICAS

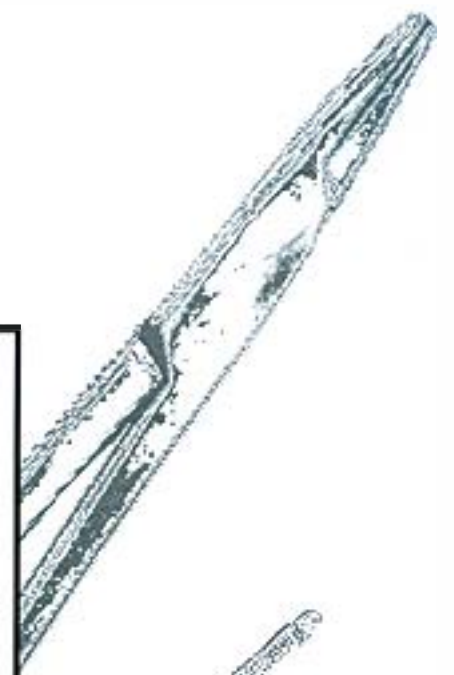
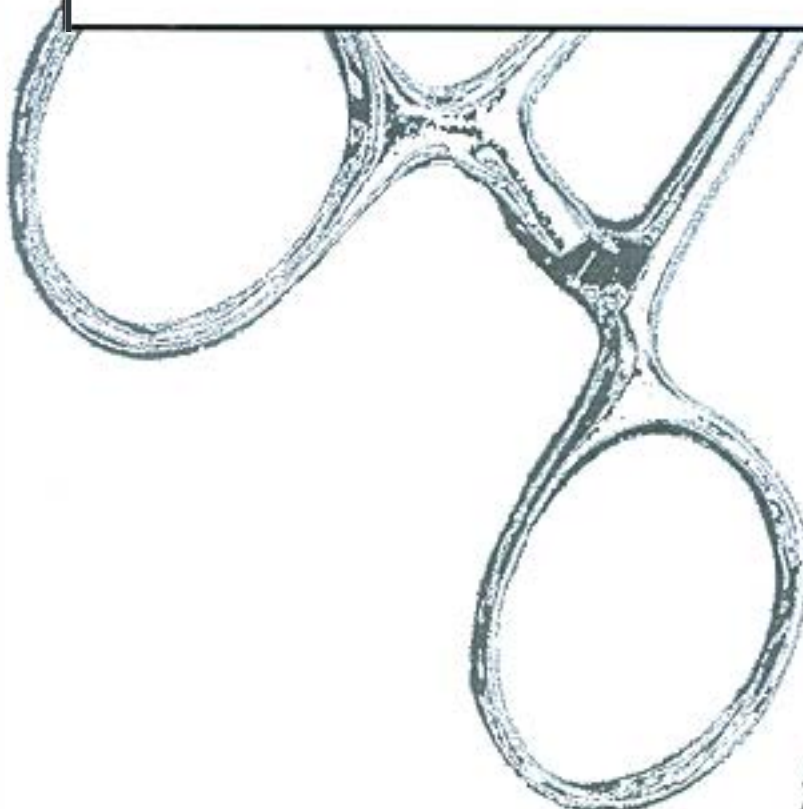
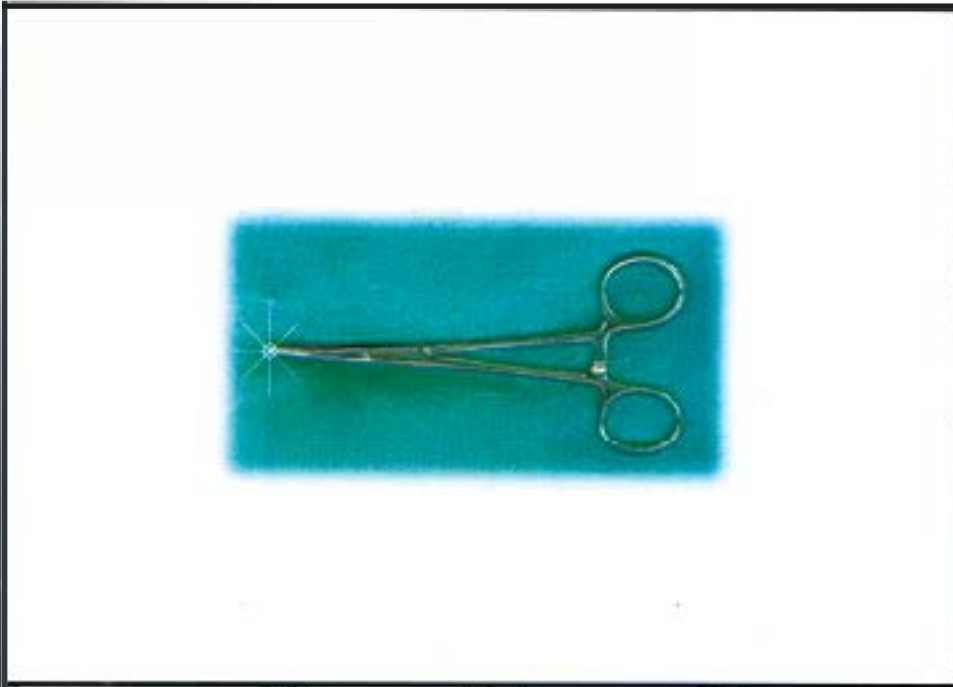

DEPARTMENT NO. 18

FROM  
PAGE#

245

TO  
PAGE#

253

INSTRUMENTS CATEGORY

ARTERY FORCEPS  
ARTERIENKLEMMEN  
PINZAS HEMOSTATICAS



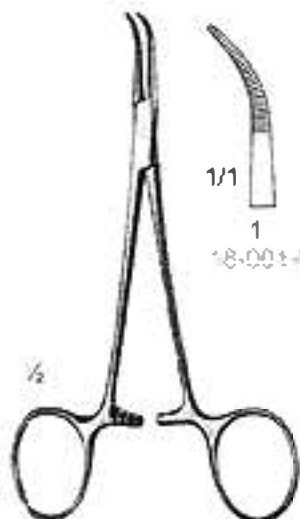

1-2  
 18-001-14  
 14 cm  
 Baby-Fixter



1/1  
 18-001-03



2  
 18-001-02

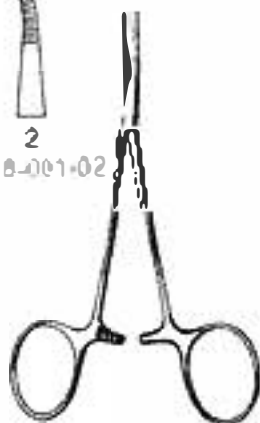

18-002-10-18-005-12  
 Micro-Mosquito



18-002-10  
 10 cm



18-002-12  
 12 cm



18-003-10  
 10 cm



18-003-12  
 12 cm



18-004-10  
 10 cm



18-004-12  
 12 cm



18-005-10  
 10 cm



18-005-12  
 12 cm

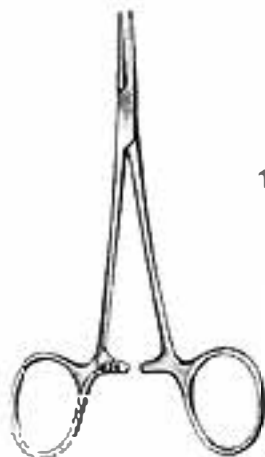

18-006-12-18-007-14  
 Fajstet-Mosquito



18-006-12  
 12 cm



18-006-14  
 14 cm



18-007-12  
 12 cm



18-007-14  
 14 cm



18-008-12  
 12 cm



18-008-14  
 14 cm



18-009-12  
 12 cm



18-009-14  
 14 cm

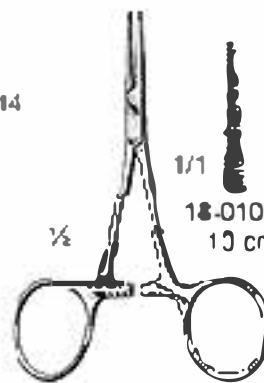

18-010-10-18-011-10  
 10 cm  
 Hartmann



1/1  
 18-010-10  
 10 cm



18-011-10  
 10 cm

ARTERY FORCEPS  
ARTERIENKLEMMEN  
PINZAS HEMOSTATICAS

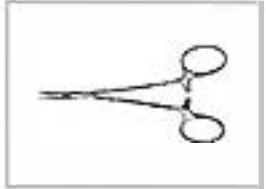

18-012-09 Str  
18-013-09 Cur  
9 cm  
Micro-Hartmann



18-014-09 Str  
18-015-09 Cur  
9 cm  
Baby-Mosquito



18-016-09 Str  
18-017-09 Cur  
9 cm  
Baby-Mosquito 1x2 teeth



18-018-10-10-021-12  
Micro-Mosquito



18-018-10  
10 cm



18-018-12  
12 cm



18-019-10  
10 cm



18-019-12  
12 cm



18-020-10  
10 cm



18-020-12  
12 cm



18-021-10  
10 cm



18-021-12  
12 cm

1x2 teeth



ARTERY FORCEPS  
 ARTERIENKLEMMEN  
 PINZAS HEMOSTATICAS



18-022-18.1. J25-21  
 Halsted-Messquite

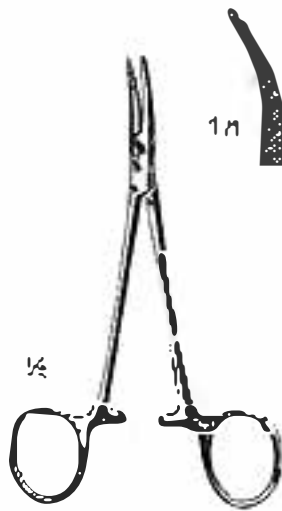
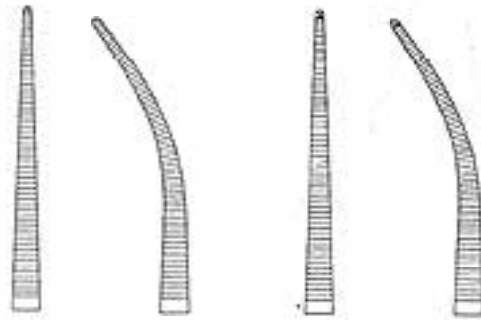
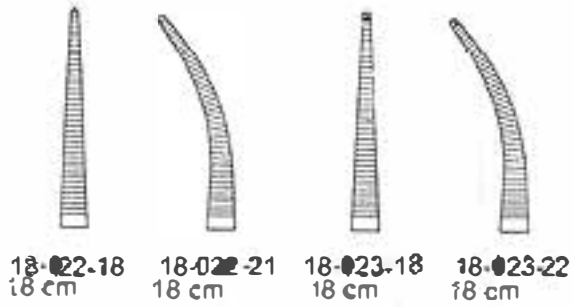

18-026-12  
 12cm

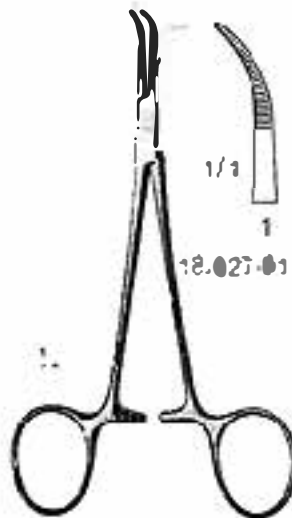

1-2  
 18-027-14  
 14 cm  
 Baby Mixter



ARTERY FORCEPS  
ARTERIENKLEMMEN  
PINZAS HEMOSTATICAS

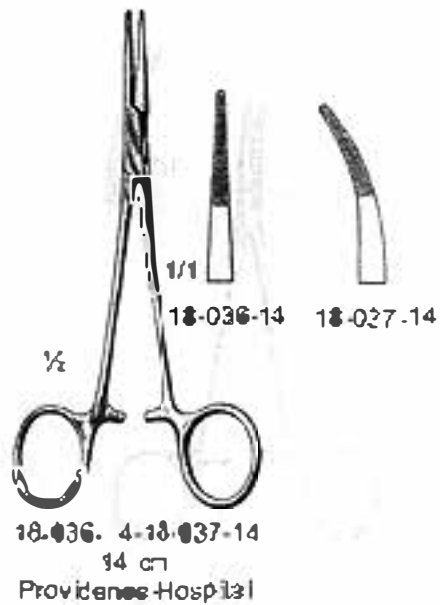
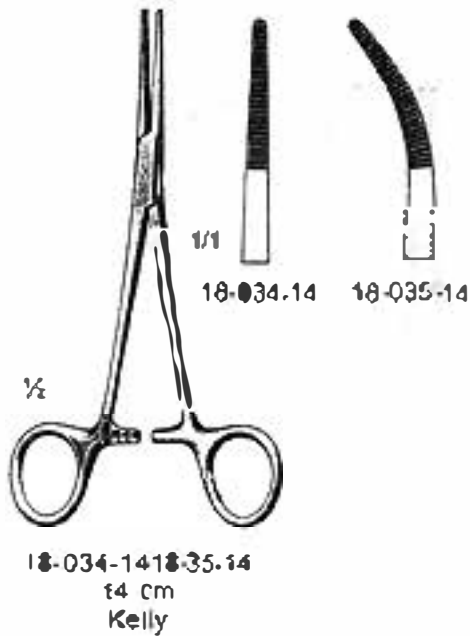
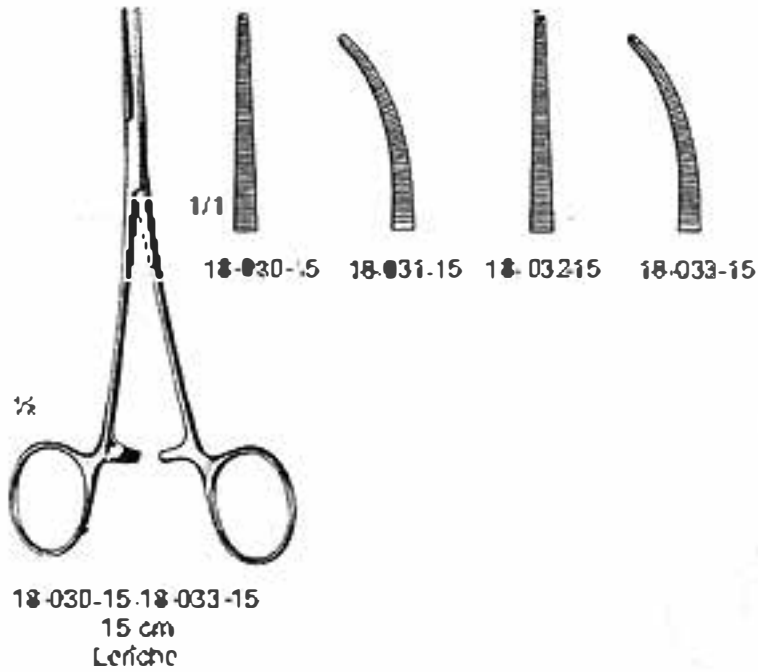
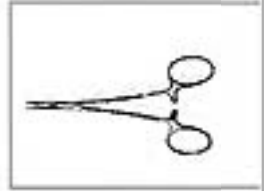

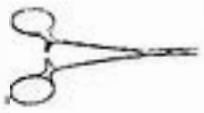

18-038-14-18-041-14  
 14 cm  
 Crile

1/1



18-038-14



18-039-14



18-040-14



18-041-14



18-042-16-18-043-16  
 16 cm  
 Kelly-Rankin

1/1



18-042-16



18-043-16

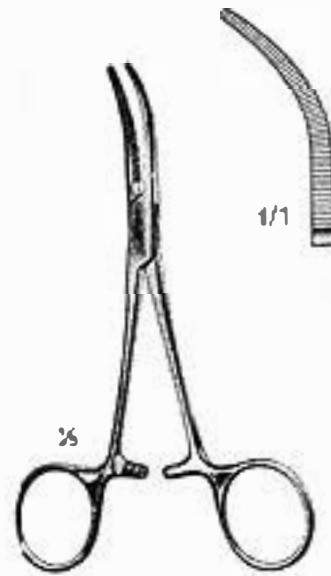

18-044-13  
 13.5 cm  
 Baby-Overtolt

1/1



ARTERY FORCEPS  
ARTERIENKLEMMEN  
PINZAS HEMOSTATICAS

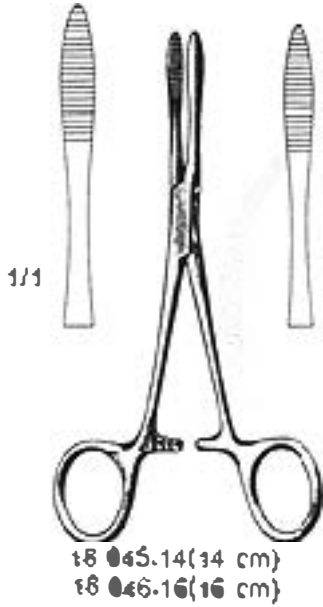
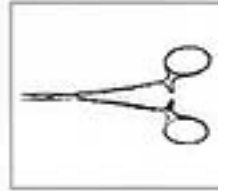

18 045-14 (14 cm)  
18 046-16 (16 cm)

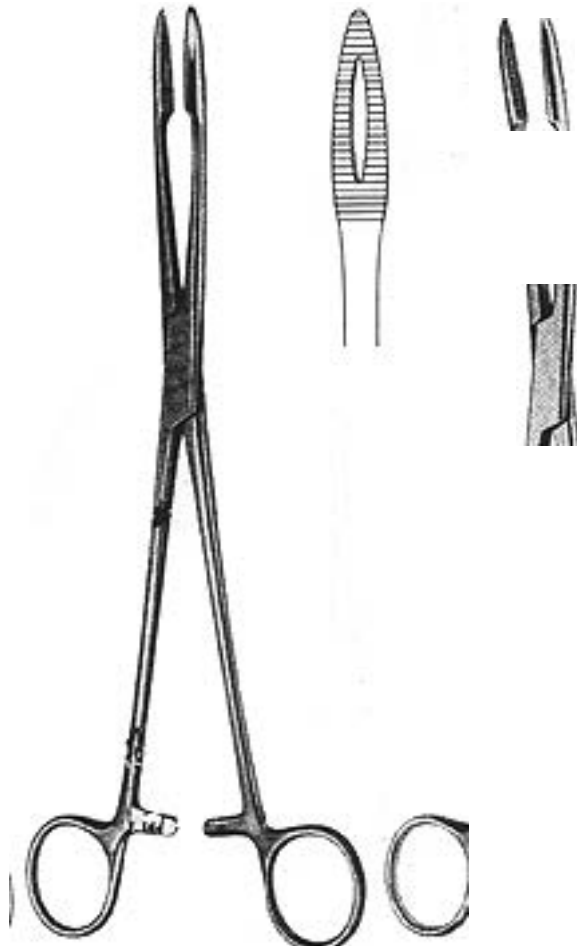
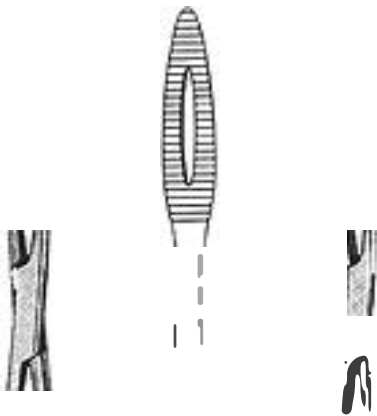

18 017 20  
20 cm

Gross

18 044 20  
20 cm

18 049 26  
26 cm

Maier

18 050 26  
26 cm



**TOWEL FORCEPS**  
**TUCHKLEMMEN**  
**PINZAS PARA COMPRESAS, PINZAS DE CAMPO**



18-051-05  
5.5 cm



18-052-08  
8 cm  
Jones



18-053-18  
18 cm  
Schäffel



18-054-08  
8 cm



18-055-13(13 cm)  
18-055-15(15cm)  
Roeder



18-056-08(8.5 cm)  
18-056-10(10 cm)



18-057-13(13 cm)  
18-057-15(15 cm)

Harkhaus

Department

19

NEEDLE HOLDERS  
NADELHALTER  
PORIA-AGUJAS

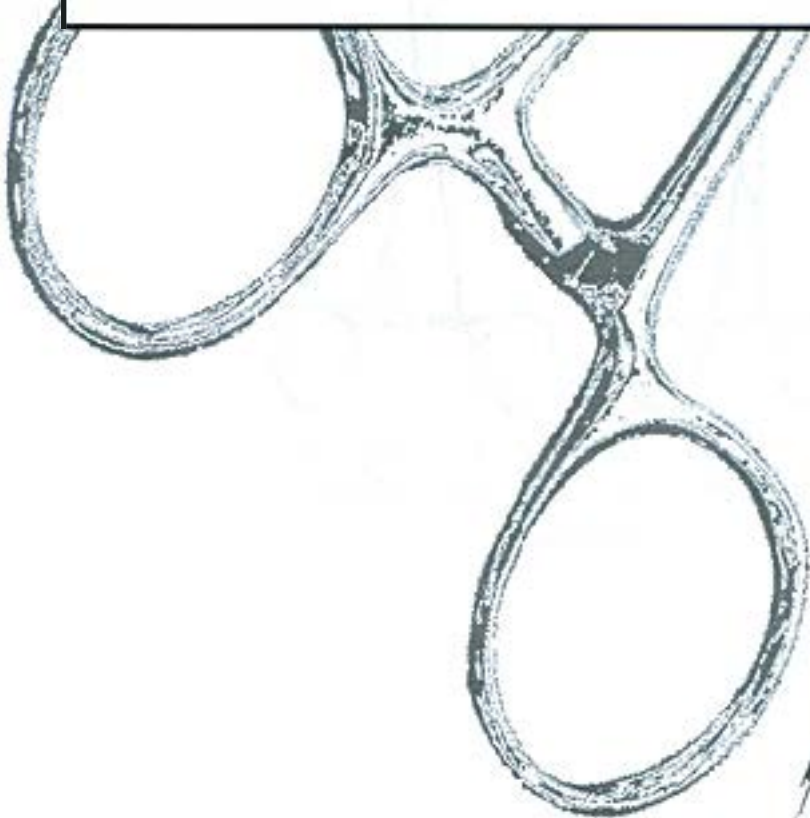
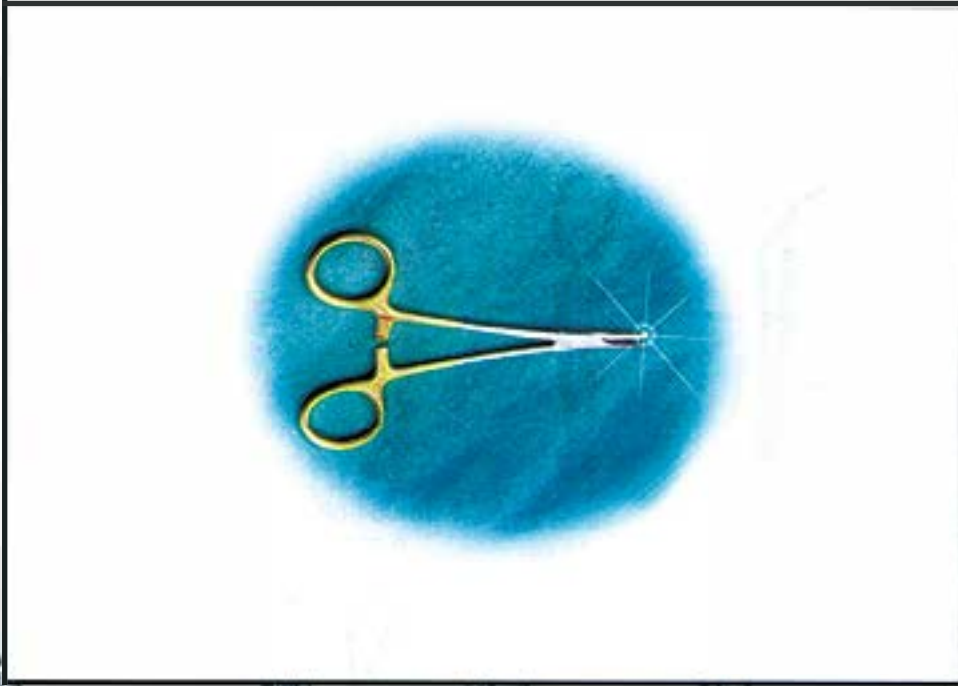





DEPARTMENT NO. 19

---

FROM  
PAGE#

254

TO  
PAGE#

265

INSTRUMENTS CATEGORY

NEEDLE HOLDERS  
NADEL HOLDERS  
PORTA-AGUJAS

# NEEDLE HOLDERS NADEL HALTER PORTA-AGUJAS

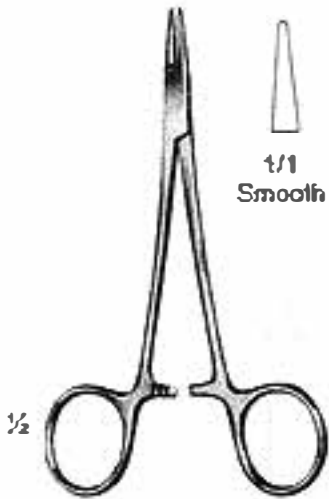
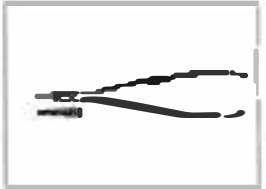

1/1  
Smooth

19-001-13  
13 cm  
Webster

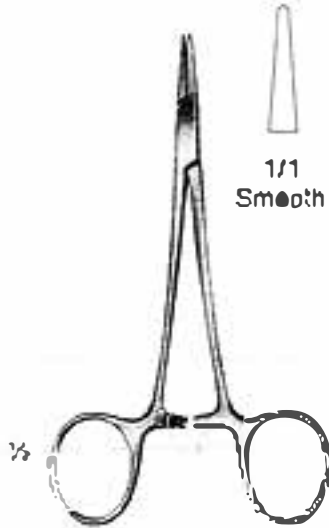

1/1  
Smooth

19-002-13  
13 cm  
Halsey

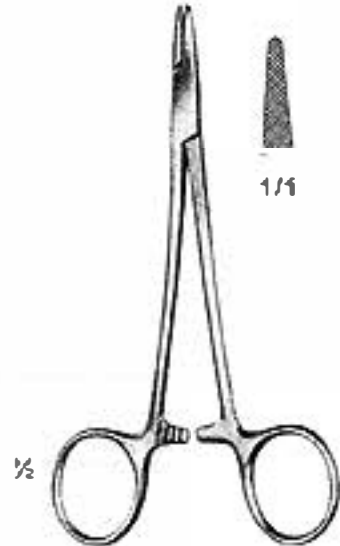

1/1

19-003-14  
14 cm  
Heger-Baumgartner

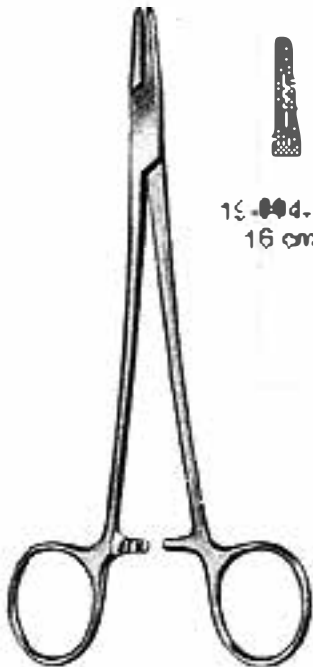

19-004-16  
16 cm



19-004-18  
18 cm

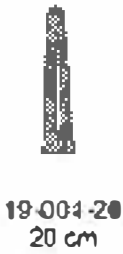

19-004-20  
20 cm

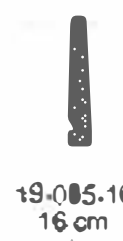

19-005-16  
16 cm



19-005-18  
18 cm



19-005-20  
20 cm

Delicate Patterns

19-004-00

19-005-00

Mayo-Hegar

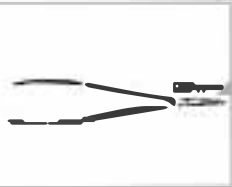

19-007-18  
18 cm  
Tennis



19-008-16  
16 cm  
Langenbeck

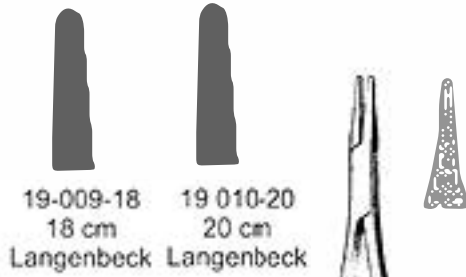

19-011-14 (14 cm)  
19-012-17 (17 cm)  
Mathieu



19-013-12  
12 cm

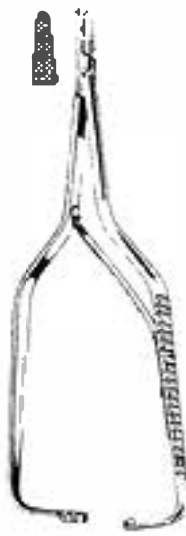

19-014-12  
12 cm

Boynton



19-015-14  
14 cm  
Aethias

19-016-17 17 cm  
19-017-20 20 cm

NEEDLE HOLDERS  
NADEL HALTER  
PORTA-AGUJAS

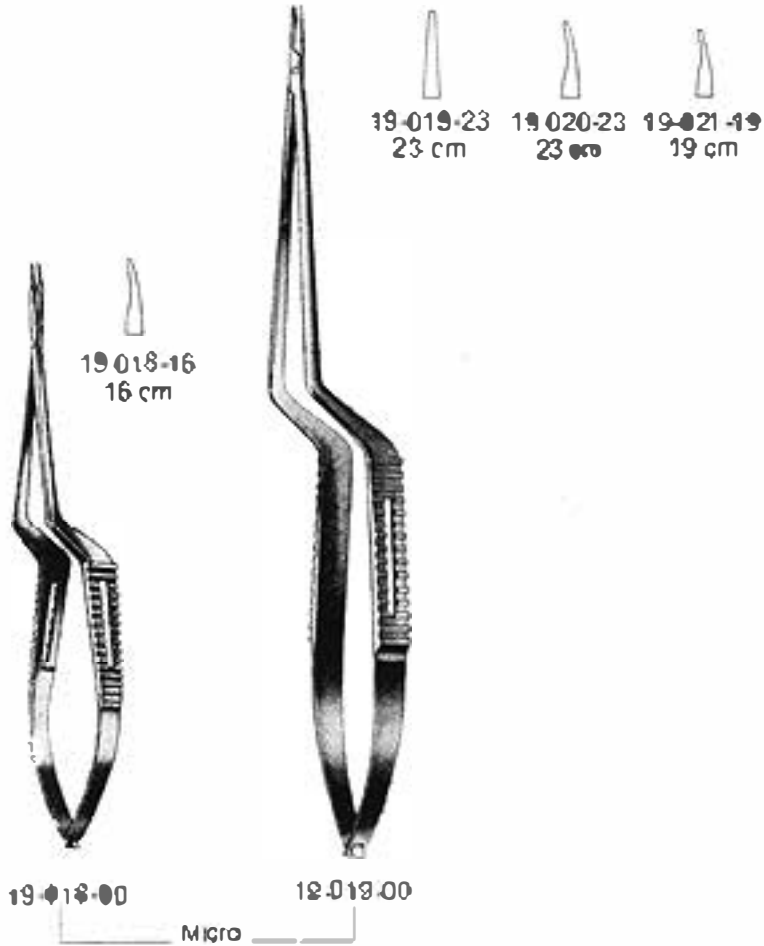

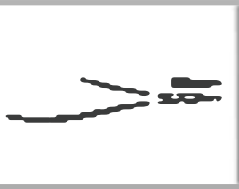

**TUNGSTEN  
 CARBIDE  
 INSERTS**



19-076-16  
 16 cm



19 077 16  
 16 cm



19-076 16  
 16 cm  
 Amiga



19 078-12  
 12 cm  
 Boyton



19 079 14(14 cm)  
 19 079 17(17 cm)  
 19 079 20(20 cm)  
 19 079-24(24 cm)  
 Mahey



19 081-16  
 16 cm



19-082 18  
 18 cm



19 083 20  
 20 cm



19 080 00  
 Langenbeck Lechl



19 084 22  
 22 cm



19-085-25  
 25 cm



19 086-17  
 17 cm  
 L chilenberg

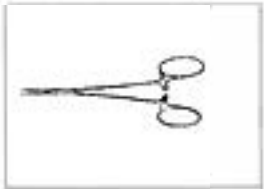

# TUNGSTEN CARBIDE INSERTS



19-087-00  
Isen-Heger

- 1/1 19-087-14 14 cm
- 19-087-16 16.5 cm
- 19-088-18 18 cm

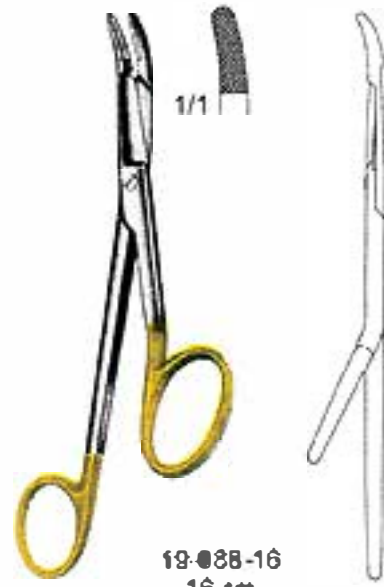

19-088-16  
16 cm  
Gillies



19-089-15  
15 cm

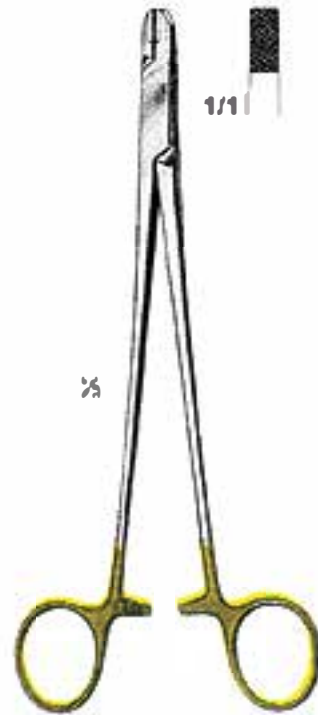

19-090-20  
20 cm

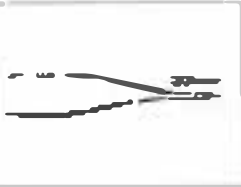

# TUNGSTEN CARBIDE INSERTS

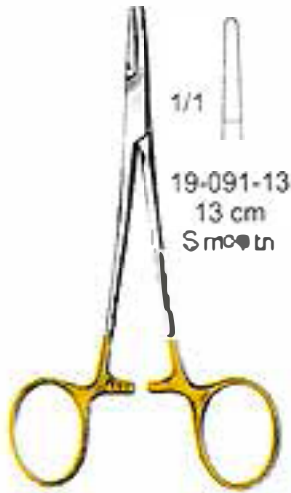

19-091-13  
13 cm  
Smooth

19-091-13  
13 cm  
Halsey



19-092-13  
13 cm

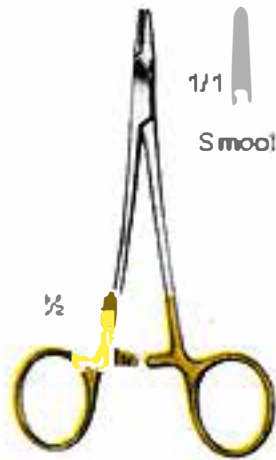

Smooth



19-093-12  
12 cm  
Webster



19-094-15  
15 cm  
Grife Wood

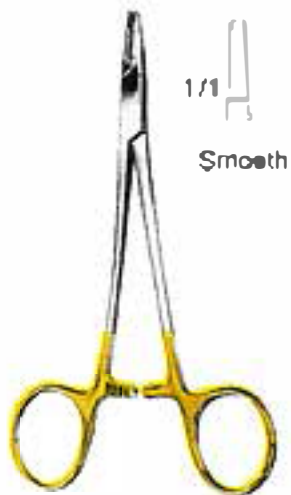

Smooth

19-095-13  
13 cm  
Webster

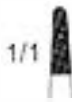
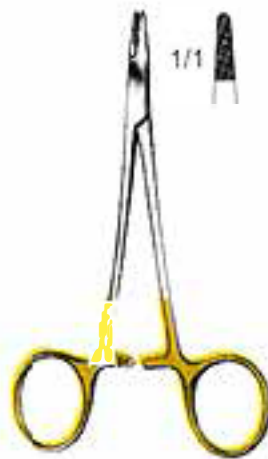

19-096-12  
12 cm  
Orf



19-097-13  
13 cm



19-097-14  
14 cm

19-097-03  
Hegar-Baumgartner

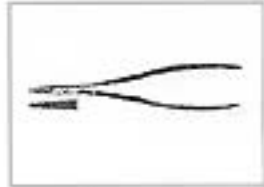

# TUNGSTEN CARBIDE INSERTS

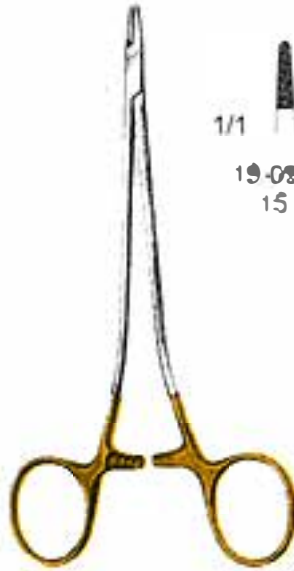

19-098-00  
Martin

- 1/1 19-098-15 15 cm
- 19-098-17 17 cm
- 19-098-20 20 cm

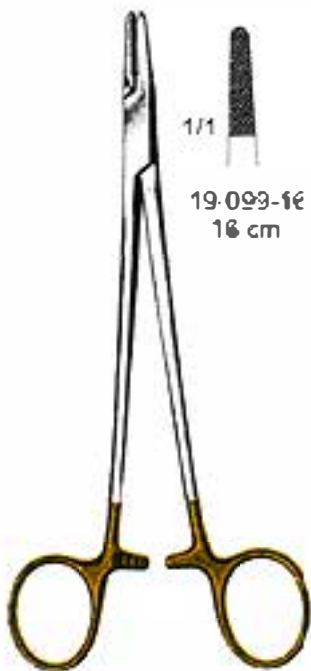

19-099-00  
Mayo-Hegar

- 1/1 19-099-16 16 cm
- 19-099-18 18 cm
- 19-099-20 20 cm



19-100-00  
Universal

- 1/1 19-100-13 13 cm
- 19-100-15 15 cm











19-101-00  
Sardol

-   
19-101-18  
18 cm
-   
19-102-20  
20 cm
-   
19-103-23  
23 cm

**TUNGSTEN  
 CARBIDE  
 INSERTS**



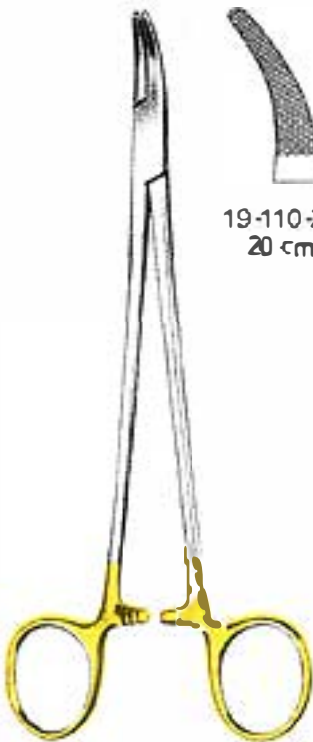

19-104-00  
Mayo Heger

-   
19-104-16  
16 cm
-   
19-105-18  
18 cm
-   
19-106-20  
20 cm
-   
19-107-24  
24 cm
-   
19-108-26  
26 cm
-   
19-109-30  
30 cm









19-110-00  
Mayo Heger (Heaney)

-   
19-110-20  
20 cm
-   
19-111-24  
24 cm
-   
19-112-26  
26 cm



19-113-00  
De Bakay

-   
19-113-16  
16 cm
-   
19-114-20  
20 cm
-   
19-115-23  
23 cm
-   
19-116-26  
26 cm
-   
19-117-31  
31 cm
-   
19-118-37  
37 cm



# TUNGSTEN CARBIDE INSERTS



19-114-00  
Vascular

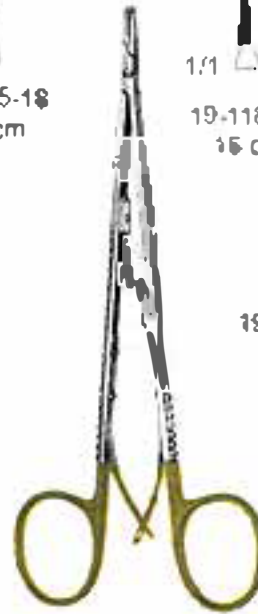

19-118-00  
Dierich

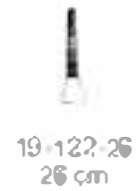

19-123-00



19-127-18  
18 cm  
Scheidt



19-128-22  
22 cm  
Polt-Smith



- 1- Probe double end
- 2- Grooved director with tongue tie
- 3- B.P. Handle No.3
- 4- B.P. Handle No.4
- 5- Thumb dressing forcep serrated 14 cm
- 6- Tissue forcep 14 cm, 1x2 teeth
- 7- Mayo hegar needle holder 14 cm
- 8- Operating scissor 14 cm SH/BL str
- 9- Operating scissor 14 cm SH/BL cvd

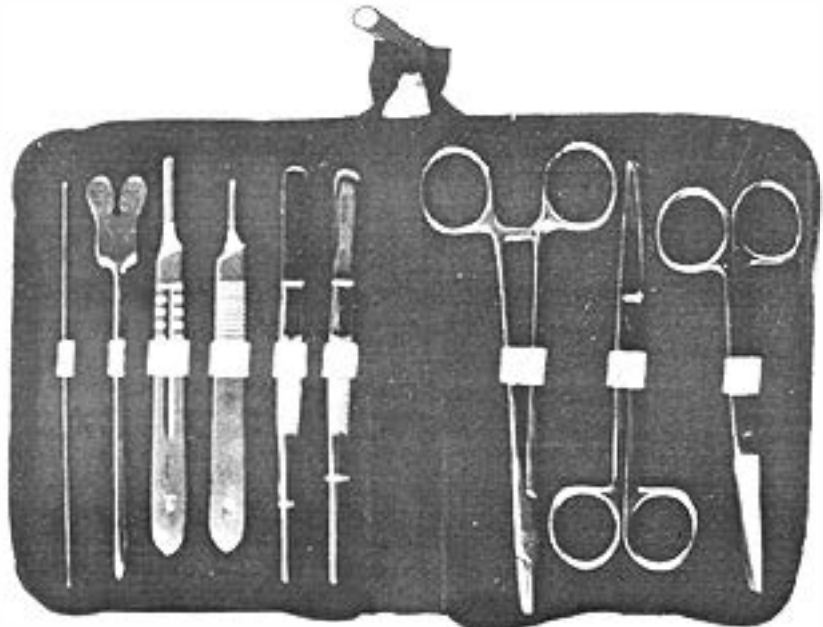

19-134-00  
 Dissecting set consisting of 9 instruments

- 1- Probe double end
- 2- Grooved director with tongue tie
- 3- B.P. Handle No.3
- 4- B.P. Handle No.4
- 5- Thumb dressing forcep serrated 14 cm
- 6- Tissue forcep 14 cm, 1x2 teeth
- 7- Mayo hegar needle holder 14 cm
- 8- Operating scissor 14 cm SH/BL str
- 9- Operating scissor 14 cm SH/BL cvd
- 10- Kelly Forcep 14 cm Str.
- 11- Kelly Forcep 14 cm Cvd.

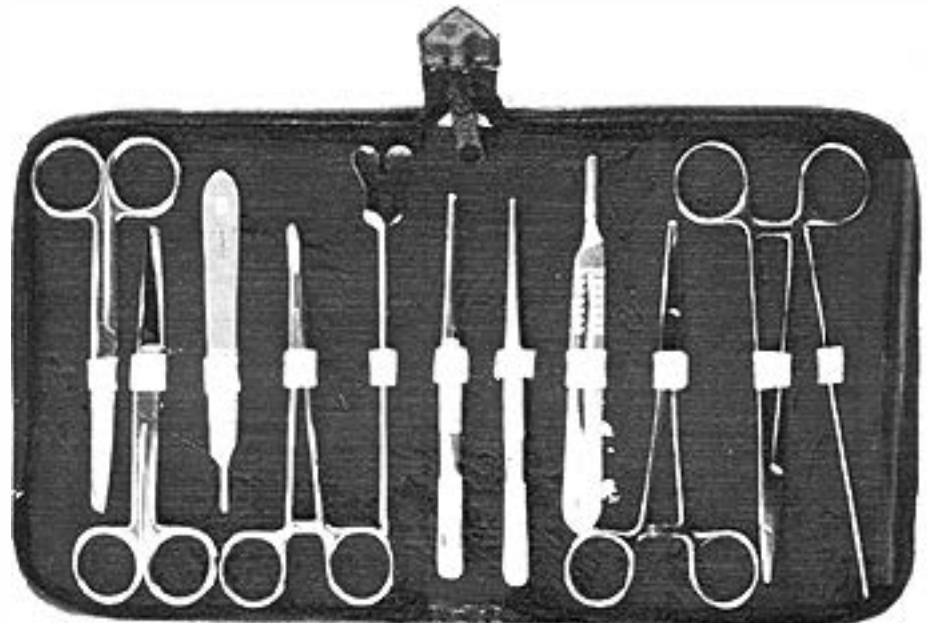

19-134-00  
 Dissecting set consisting of 11 instruments

Department

20

INSTRUMENTS BOXES  
INSTRUMENTENBEHALTER  
CONTENEDORES PARA INSTRUMENTOS

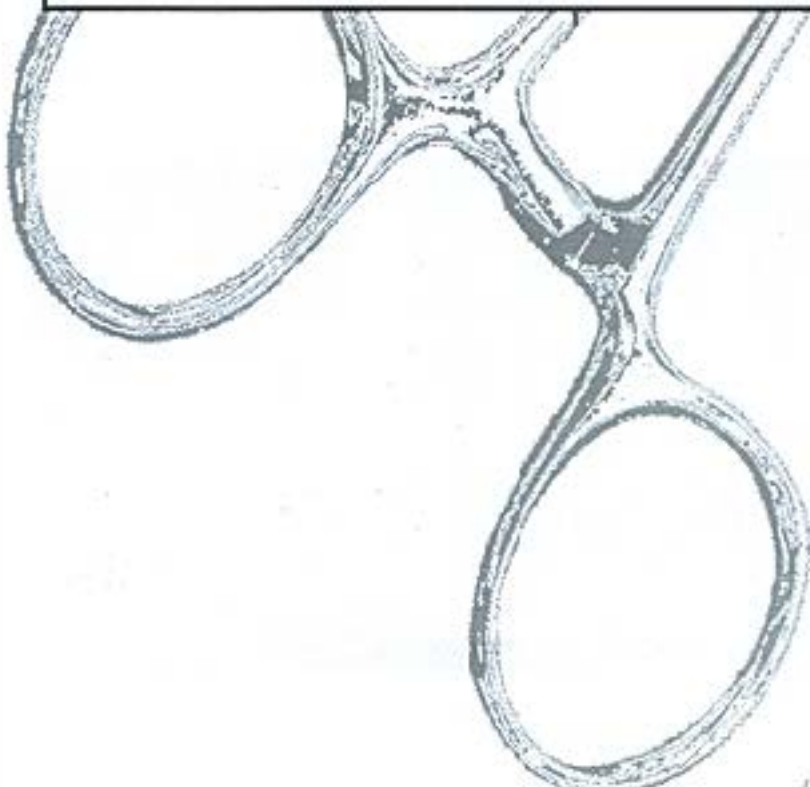
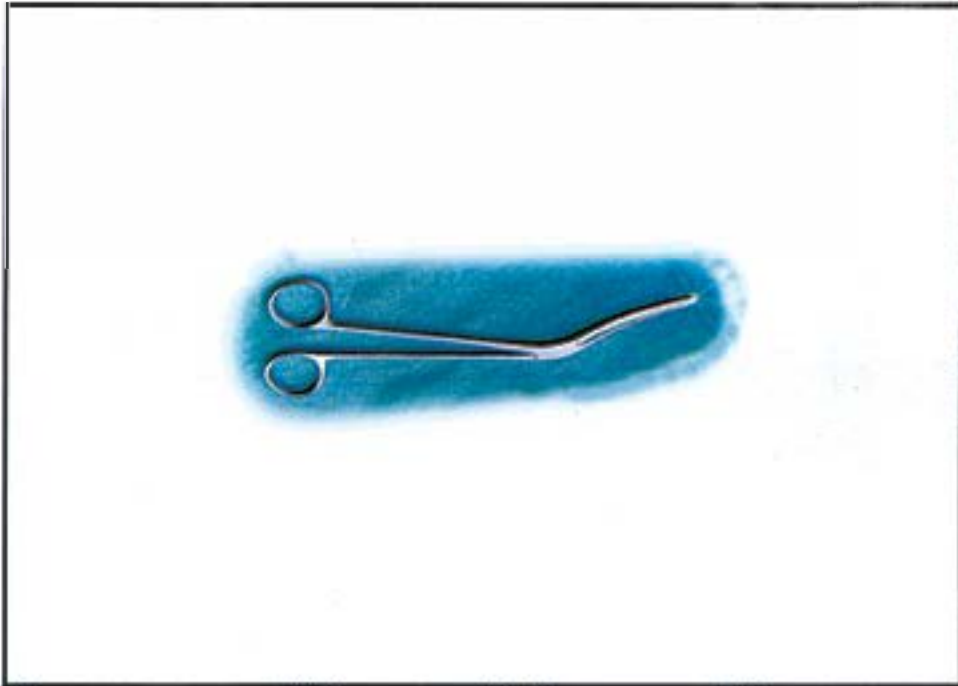

DEPARTMENT NO. 23

---

FROM  
PAGE#

266

TO  
PAGE#

272

INSTRUMENTS CATEGORY

INSTRUMENTS BOXES  
INSTRUMENTENBEHALTER  
CONTENEDORES PARA INSTRUMENTOS

STERILIZER FORCEPS  
 STERILISIERZANGEN  
 PINZAS PARA ESTERLIZAR

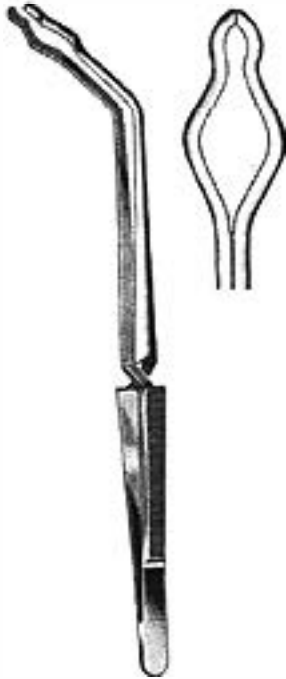
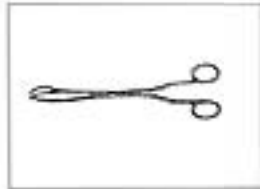

20-001-18(18 cm)  
 20-002-25(25 cm)  
 Mod. Martin



20-003-16(16 cm)  
 20-004-20(20 cm)  
 20-005-24(24 cm)  
 Davis



20-006-25(25 cm)  
 20-007-30(30 cm)  
 Pye-Smith  
 (Harrison)



20-008-23  
 23 cm  
 Rogge



20-009-20(20 cm)  
 20-010-30(30 cm)



20-011-27  
 27 cm  
 Cheate



20-012-24  
24 CM



20-013-24  
24 CM  
Ulleval



20-014-20(20 cm)  
20-015-28(28 cm)



20-016-20(20 cm)  
20-017-28(28 cm)

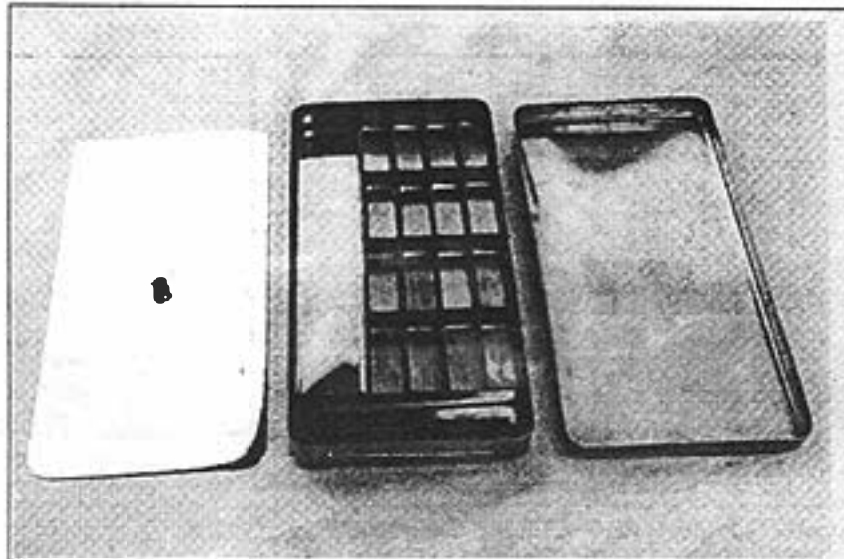

20-018-00  
Endodontics Try  
Curatagge Case Double Cap

**INSTRUMENTS BOXES  
INSTRUMENTENBEHALTER  
CONTENEDORES PARA INSTRUMENTOS**



L	W	H
20-066-00	(17x7x3 cm)	
20-067-00	(17.5x7.5x3 cm)	
20-068-00	(18x6x3 cm)	
20-069-00	(18x7x3 cm)	
20-070-00	(18x9x4 cm)	
20-071-00	(20x10x4 cm)	
20-072-00	(21x10x4 cm)	

Instrument Boxes  
in Different Sizes

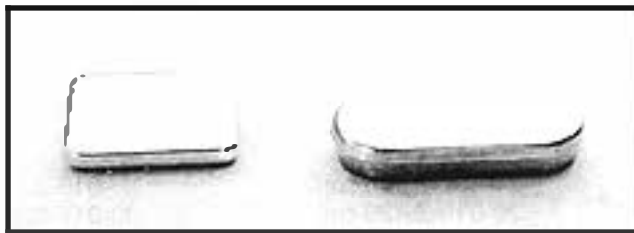
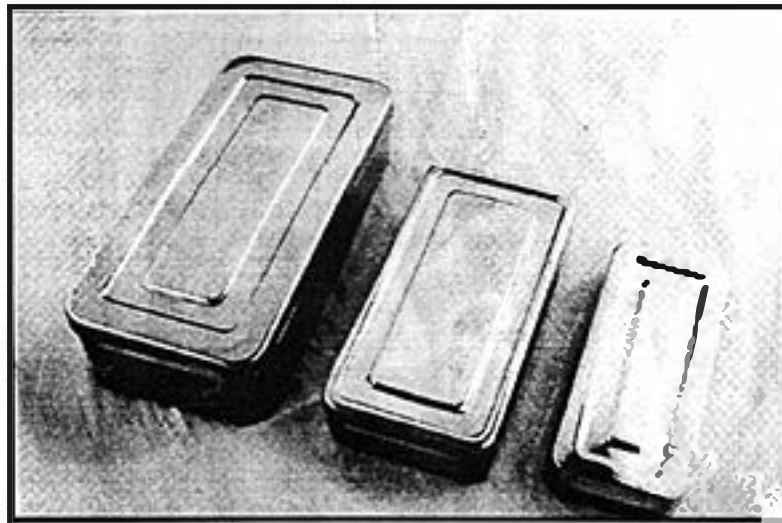

20-073-00  
Needle Case

20-074-00 (5 cc)  
20-075-00 (2 cc)  
Syringe Case



20-076-00  
Finger Cup

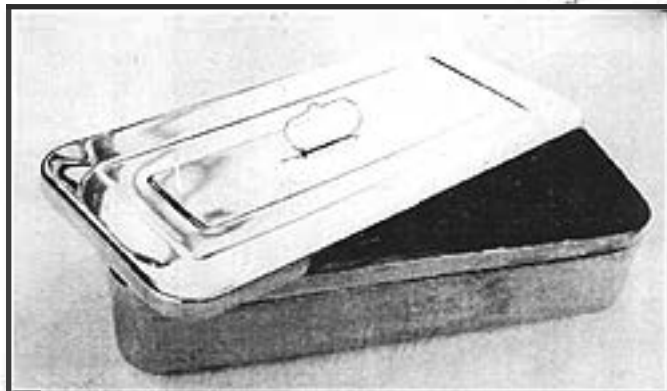

L	W	H	L	W	H
20-077-00	(30x15x10 cm)		20-083-00	(40x20x10 cm)	
20-078-00	(30x17x5 cm)		20-084-00	(40x30x5 cm)	
20-079-00	(34x16x5 cm)		20-085-00	(40x30x10 cm)	
20-080-00	(36x24x5 cm)		20-088-00	(42x19x5 cm)	
20-081-00	(36x24x10 cm)		20-087-00	(45x30x5 cm)	
20-082-00	(40x20x5 cm)		20-088-00	(45x30x10 cm)	

Instrument Boxes  
in Different Sizes

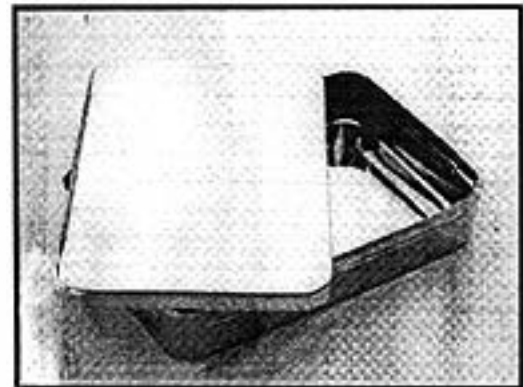

L	W	H
20-089-00	(23x15x5 cm)	
20-090-00	(25x12x5 cm)	
20-091-00	(24x12x10 cm)	
20-092-00	(28x15x5 cm)	
20-093-00	(30x15x5 cm)	
20-094-00	(35x8x4 cm)	

Instrument Boxes  
in Different Sizes





**STERILIZING/DRESSING DRUM  
STERILISING/PRAPARIERTROMMEL  
TAMBOR PARA ESTERILIZACION Y PREPARACION**

20

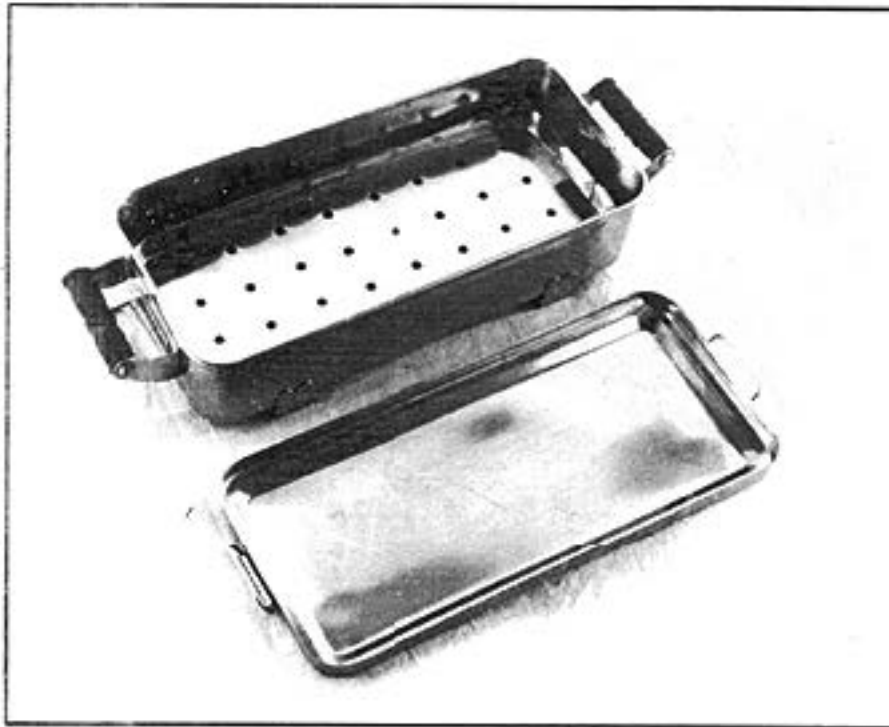

20-095-00 (27x12x6 cm)  
Sterilizer With Heater



- |                      |                      |
|----------------------|----------------------|
| 20-096-00 (24x12 cm) | 20-101-00 (34x28 cm) |
| 20-097-00 (30x15 cm) | 20-102-00 (37x30 cm) |
| 20-098-00 (30x30 cm) | 20-103-00 (39x14 cm) |
| 20-099-00 (34x16 cm) | 20-104-00 (39x20 cm) |
| 20-100-00 (34x24 cm) | 20-105-00 (39x29 cm) |

● Dressing/Sterilizing Drum  
In Different Sizes

- 20-106-00 (8x8 cm)
- 20-107-00 (10x10 cm)
- 20-108-00 (12x12 cm)
- 20-109-00 (15x15 cm)
- 20-110-00 (16x12 cm)
- 20-111-00 (18x18 cm)
- 20-112-00 (19x14 cm)
- 20-113-00 (19x20 cm)
- 20-114-00 (20x16 cm)
- 20-115-00 (20x20 cm)
- 20-116-00 (24x16 cm)
- 20-117-00 (24x24 cm)
- 20-118-00 (29x14 cm)
- 20-119-00 (29x16 cm)
- 20-120-00 (29x24 cm)

● Dressing/Sterilizing Drum  
in different sizes

STERILIZING, DRESSING JAR & FORCEPS  
 STERILISING, PRAPARIERBEHALTER, ZANGENBEHALTER  
 CAJA PARA ESTERILIZACION Y PREPARACION CAJA PARA PINZAS

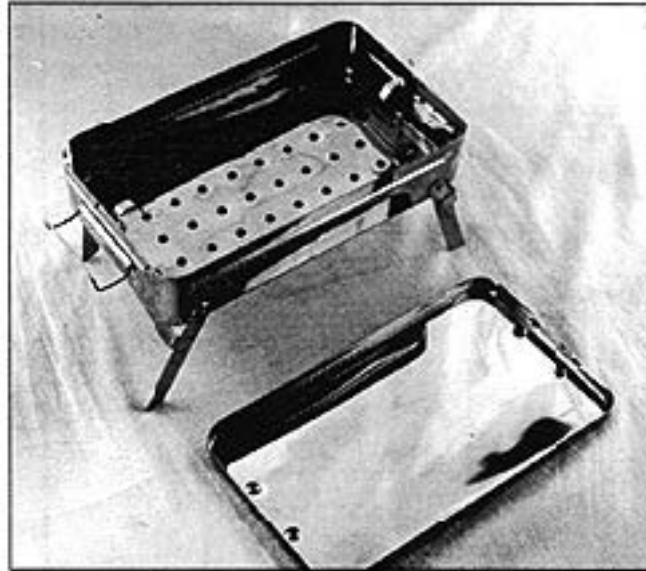

20-121-00 (20x10x5 cm)  
 20-122-00 (25x12x5 cm)  
 20-123-00 (26x15x5 cm)

Spring Sterilizer With Perforated Tray Stand And Lid.



20-124-00 (7.5x7.5 cm)    20-128-00 (18x18 cm)  
 20-125-00 (10x10 cm)    20-129-00 (10x12.5 cm)  
 20-126-00 (12.5x12.5 cm)    20-130-00 (20x20 cm)  
 20-127-00 (15x15 cm)

Cotton/Dressing Jar With Lid. Consisting of Different Sizes.



20-131-00 (5x11.5 cm)  
 20-132-00 (5x16.5 cm)

20-133-00 (3x11 cm)  
 20-133-00  
 Thermometer Jar.

Forceps Jar/Chettle Jar Consisting of Different Sizes

Department

21

RUBBER DAM INSTRUMENTS  
KOFFERDAM - INSTRUMENTE  
INSTRUMENTOS PARA DIQUE DE GOMA

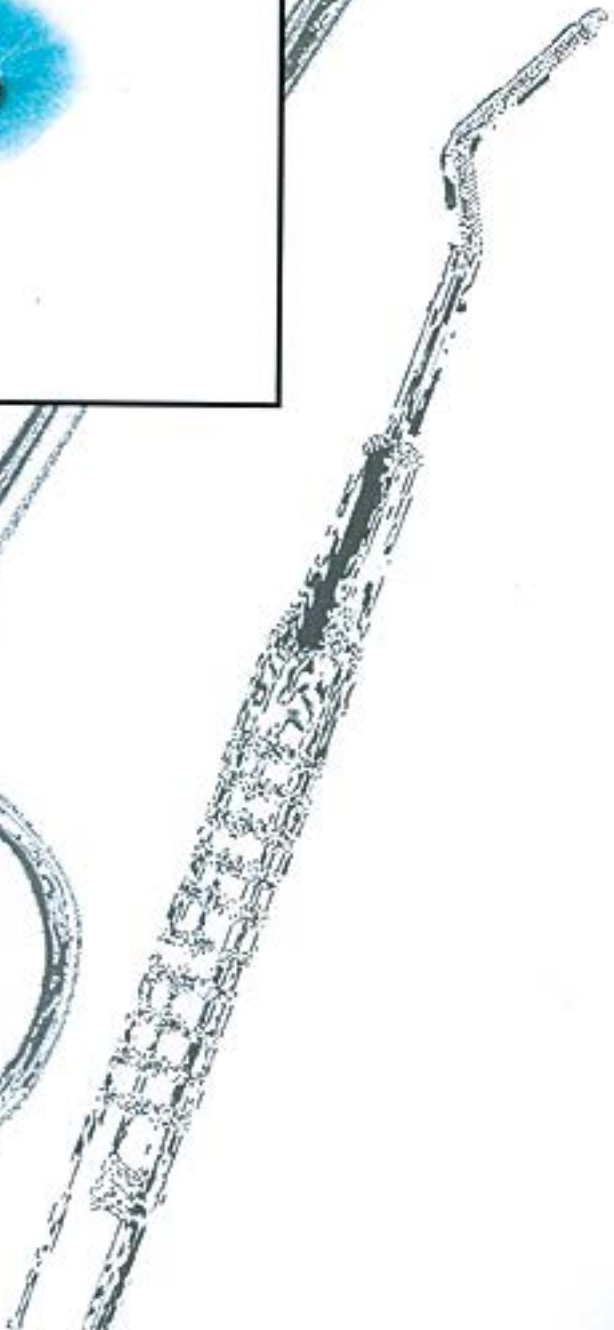
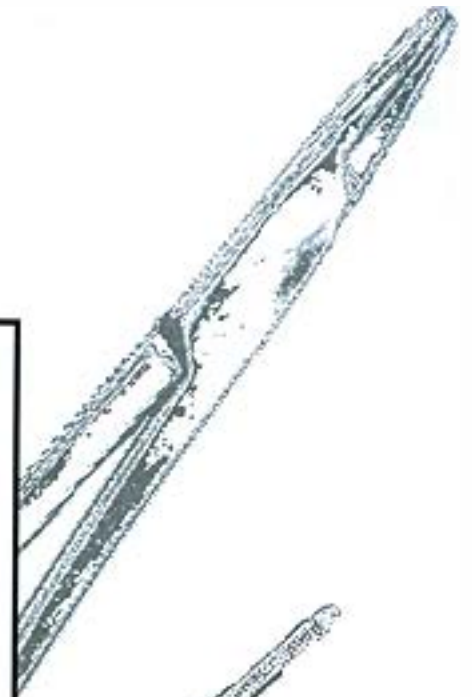
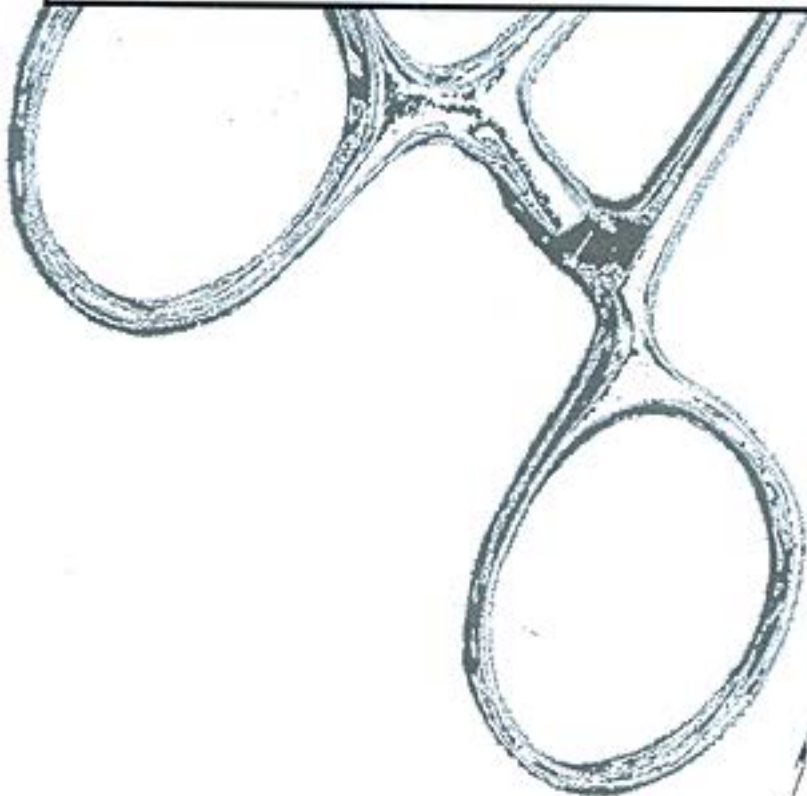
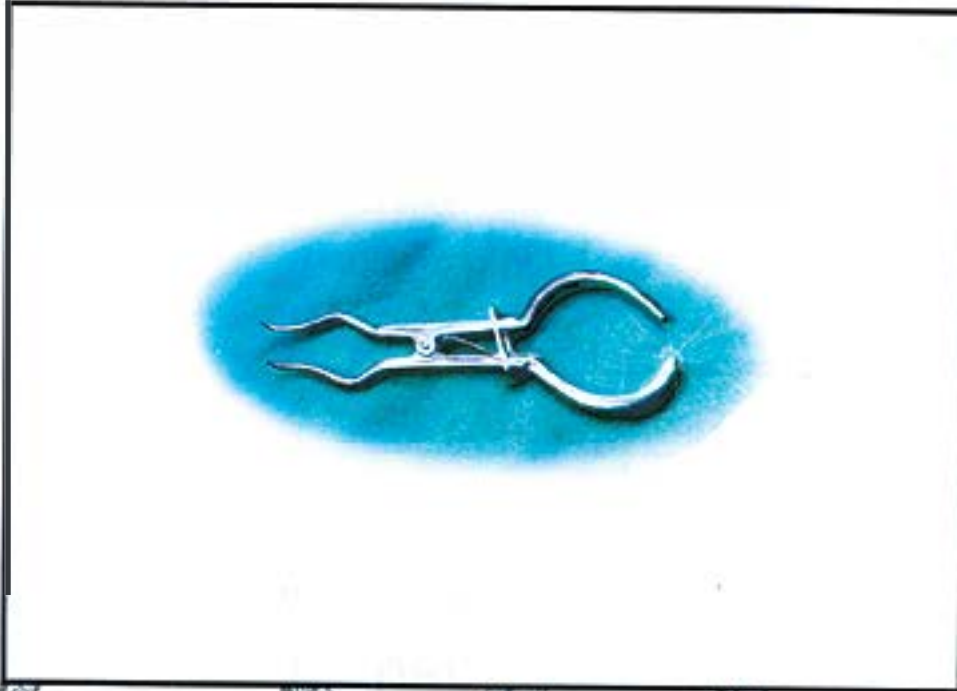

DEPARTMENT NO. 21

---

FROM  
PAGE#

273

TO  
PAGE#

280

INSTRUMENTS CATEGORY

RUBBER DAM INSTRUMENTS  
KOFFERDAM - INSTRUMENTE  
INSTRUMENTOS PARA DIQUE DE GOMA

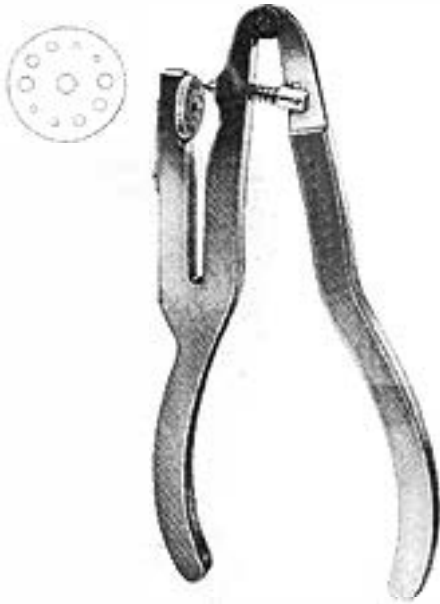
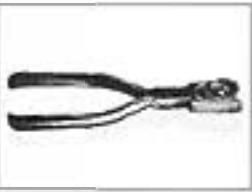

21-001-00  
Ivory  
With two rows of holes

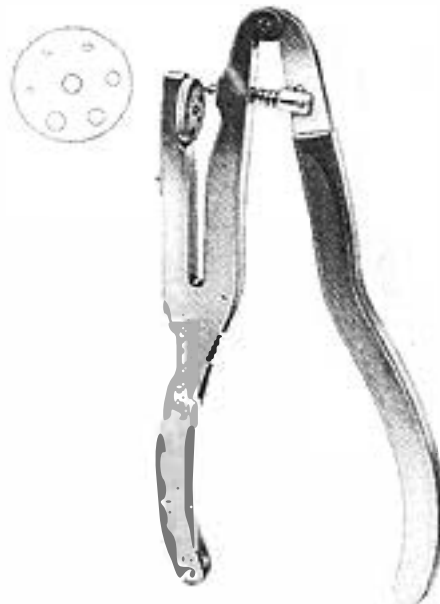

21-002-00  
Ivory  
With one row of holes



21-003-00



21-004-00

Ainsworth

RUBBER DAM INSTRUMENTS  
KOFFERDAM - INSTRUMENTE  
INSTRUMENTOS PARA DIQUE DE GOMA

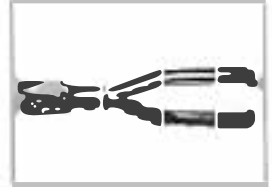

21-005-00  
Ainsworth type rubber  
dam punch



21-006-00



21-007-00  
Light weight rubber  
dam punch



21-008-17  
17 cm  
Ainsworth

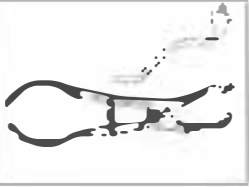

Full  
Size

21-009-00  
Ivory

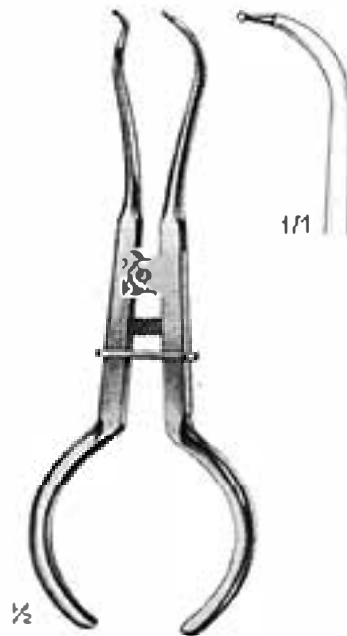

1/1

21-010-00  
White

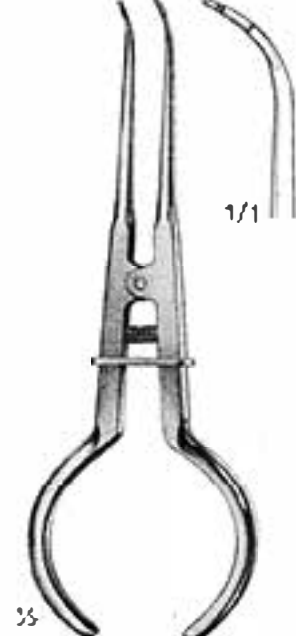

1/1

1/1

21-011-00  
Palmer

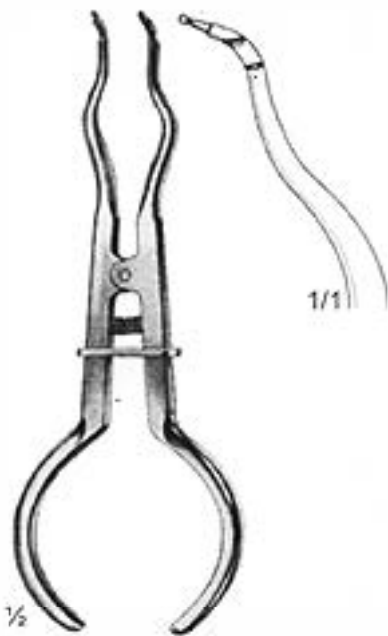

1/1

1/2

21-012-00  
Brewer

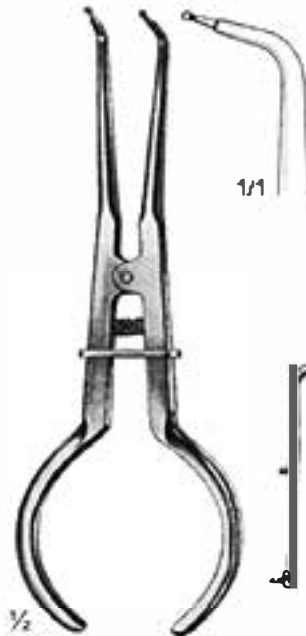

1/1

1/2

21-013-00  
Stockes

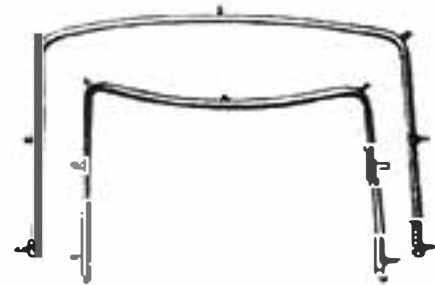

21-014-00 (Large)  
21-015-00 (Small)  
Rubber Dam Frame

RUBBER DAM CLAMPS  
KOFFERDAM - CLAMMERNS  
CLAMPS PARAD QUE



201  
21 016 00



202  
21 017 00



203  
21 010 00



204  
21 019 00



205  
21 020 00



3  
21 021 00



4  
21 022 00



5  
21 023 00



8  
21 024 00



8A  
21 025 00



12A  
21 026 00



13A  
21 027 00



14  
21 028 00



14A  
21 029 00



200  
21 030 00





RUBBER DAM CLAMPS  
KOFFERDAM - CLAMMERNS  
CLAMPS PARA DIQUE

21



24  
21-031-00



25  
21-032-00



26  
21-033-00



28  
21-034-00



30  
21-035-00



51  
21-036-00



138  
21-037-00



130  
21-038-00



31  
21-039-00



W&A  
21-040-00



W14  
21-041-00



W14A  
21-042-00



15  
21-043-00



18  
21-044-00

279

RUBBER DAM CLAMPS  
KOFFERDAM - CLAMMERNS  
CLAMPS PARA DIQUE



212  
21-045-00



22  
21-046-00



27  
21-047-00



29  
21-048-00



210  
21-049-00



211  
21-050-00



21-051-00



206  
21-052-00



207  
21-053-00



208  
21-054-00



209  
21-055-00



W2  
21-062-00



W3  
21-059-00



W13  
21-057-00



2A  
21-068-00



9  
21-056-00



26N  
21-063-00



2  
21-060-00



7  
21-064-00



7A  
21-061-00



12  
21-065-00



17 N  
21-066-00



58  
21-067-00



60  
21-068-00



80  
21-069-00



210  
21-070-00



210  
21-071-00

Department

22

CROWN INSTRUMENTS  
KRONENINSTRUMENTE  
INSTRUMENTOS PARA CORONAS

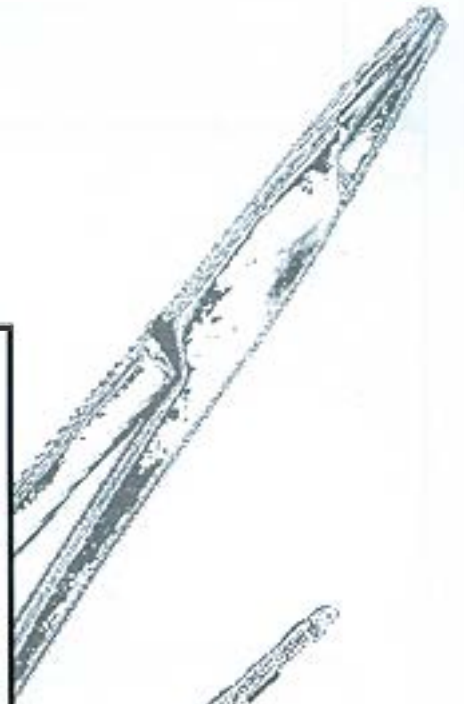
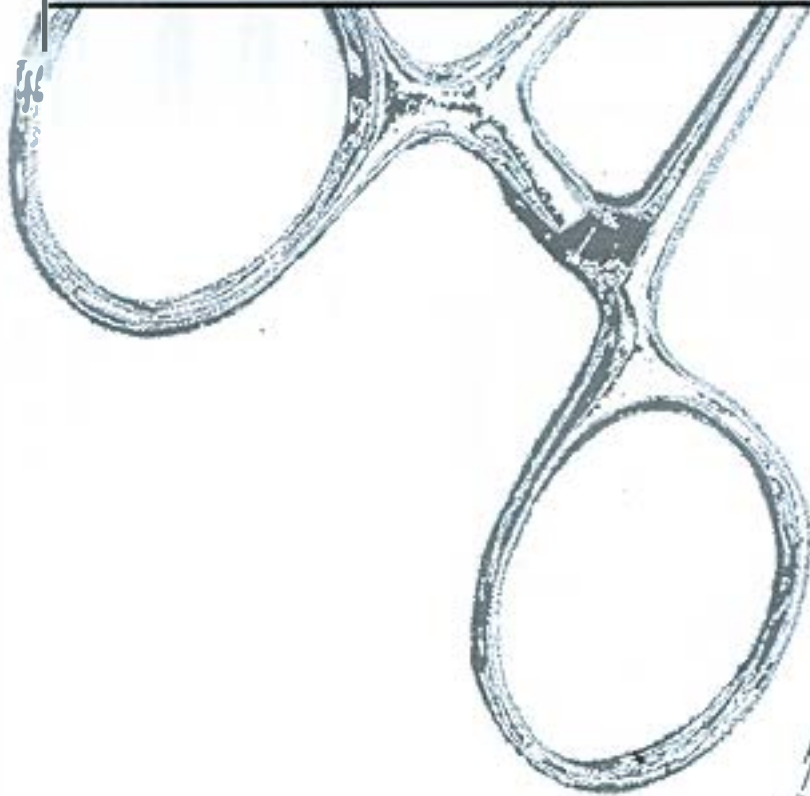
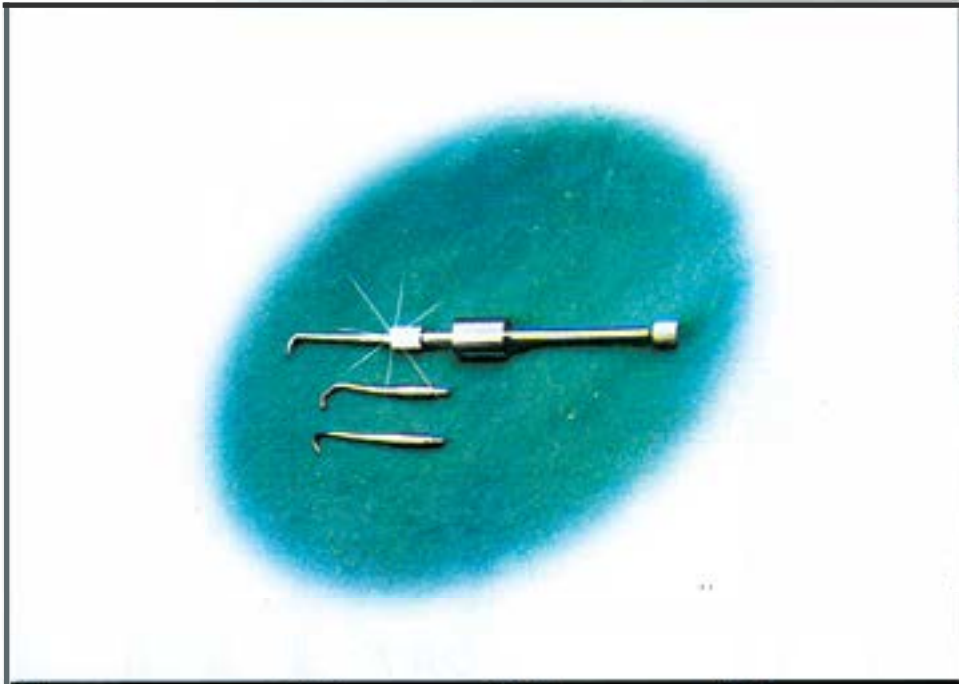

DEPARTMENT NO. 22

---

FROM  
PAGE#

281

TO  
PAGE#

287

INSTRUMENTS CATEGORY

CROWN INSTRUMENTS  
KRONENINSTRUMENTE  
INSTRUMENTOS PARA CORONAS



CROWN INSTRUMENTS  
 KRONEN INSTRUMENTE  
 INSTRUMENTOS PARA CORONAS



1-3  
22-001-00

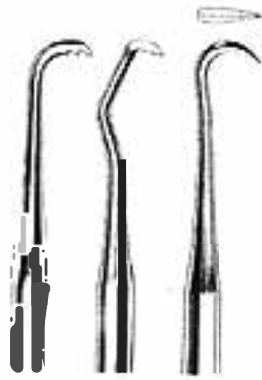

1 2 3  
22-001-01 22-001-02 22-001-03



1-3  
22-002-00



0-9  
22-003-00

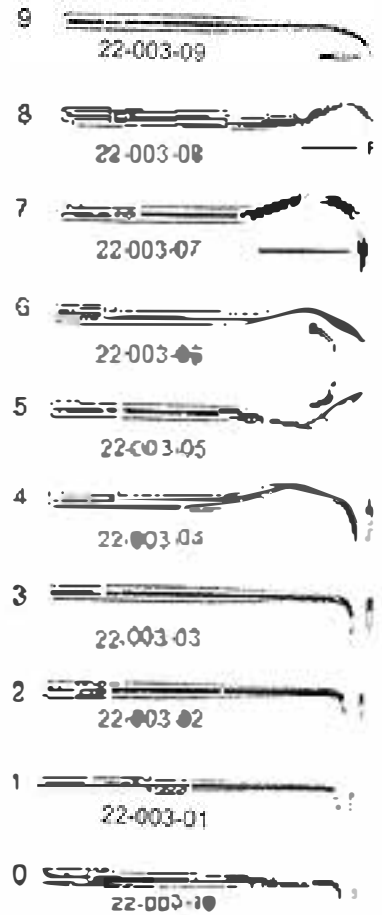

# CROWN INSTRUMENTS KRONEN INSTRUMENTE INSTRUMENTOS PARA CORONAS



1-3  
22-054-00  
Crown Remover



1

22-054-01



2

22-054-02



3

22-054-03

Fonts  
Complete With 3  
Attachments



22-055-00



1-2  
22-056-00



1

22-056-01



2

22-056-02

Points  
Complete With 3  
Attachments



CROWN INSTRUMENTS  
KRONEN INSTRUMENTE  
INSTRUMENTOS PARA CORONAS

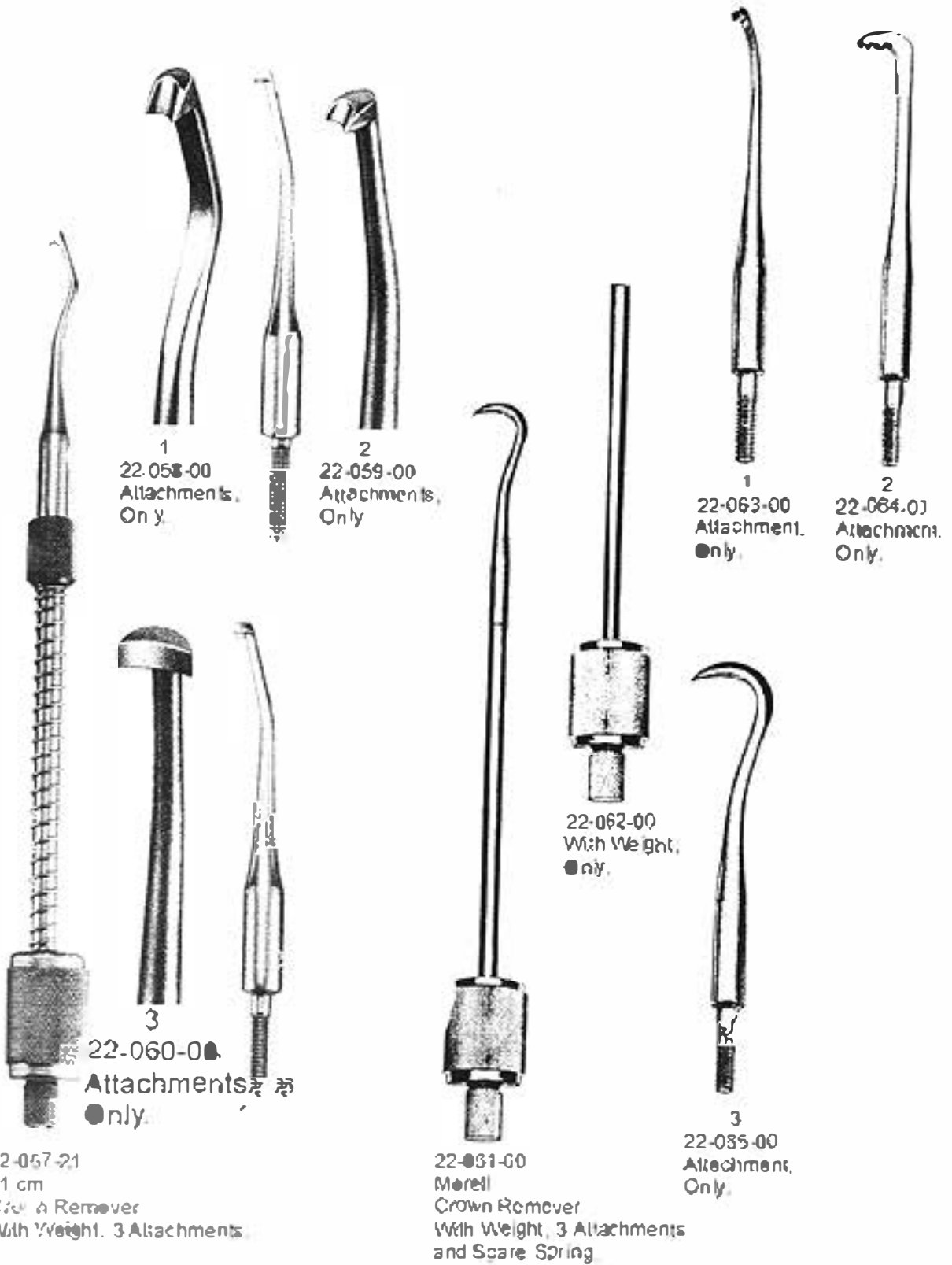

CROWN INSTRUMENTS  
KRONEN INSTRUMENTE  
INSTRUMENTOS PARA CORONAS

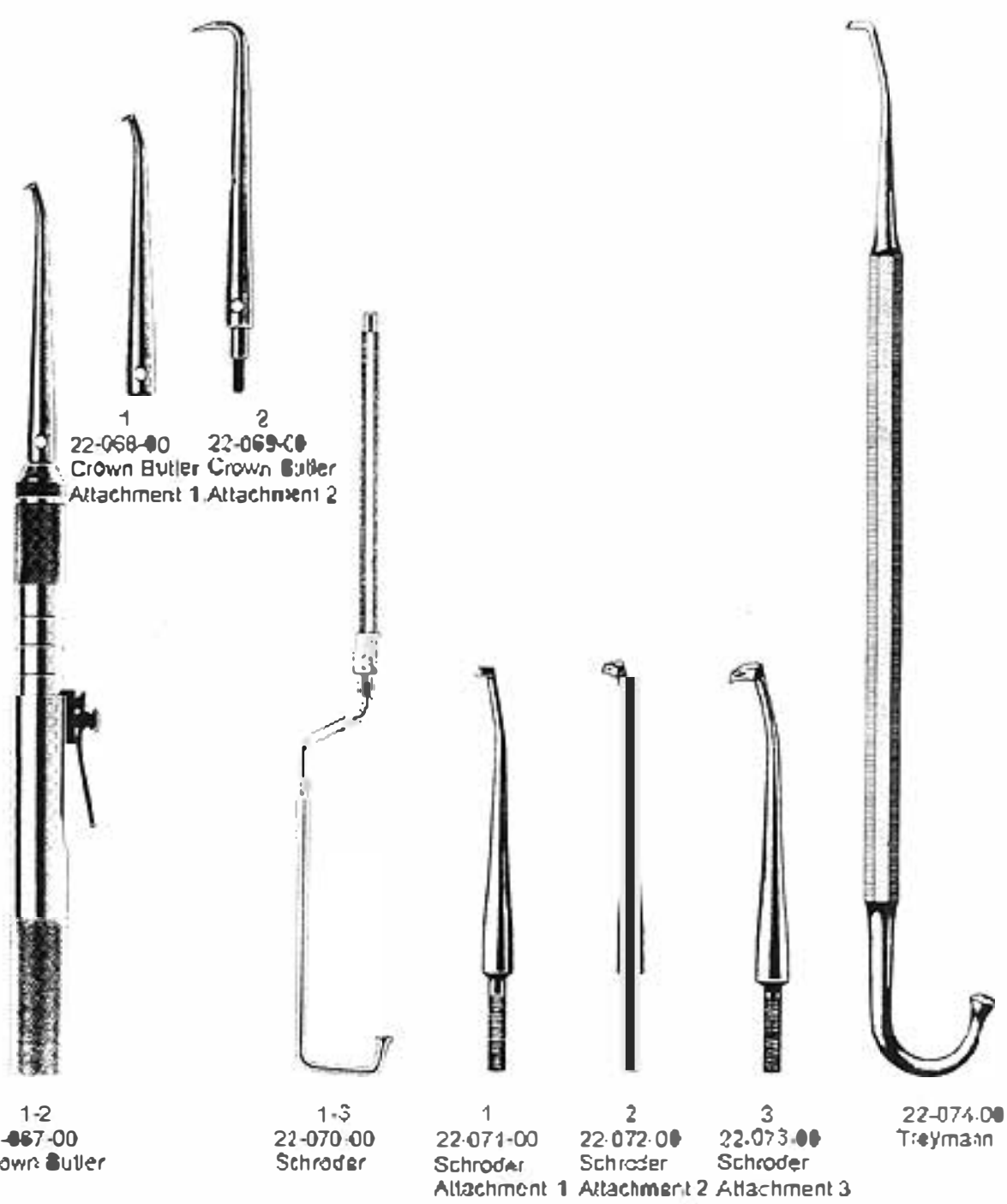

1  
22-068-00 Crown Butler Attachment 1

2  
22-069-00 Crown Butler Attachment 2

1-2  
22-067-00 Crown Butler

1-3  
22-070-00 Schroder

1  
22-071-00 Schroder Attachment 1

2  
22-072-00 Schroder Attachment 2

3  
22-073-00 Schroder Attachment 3

22-074-00 Treymann





1-3  
22-076-00



Crown  
Removing Forcep  
17 cm  
22-078-17



22-097-00

Crown & Bridge Holding Forceps with support Ring  
22-096-00



Ligature Instrument  
22-098-00



Saliva Ejectors  
22-099-00 Ø 3 mm  
22-100-00 Ø 4 mm  
22-101-00 Ø 5 mm  
15 cm

Department

23

AMALGAM CARRIERS  
AMALGAMPISTOLEN  
PORTA AMALGAMAS

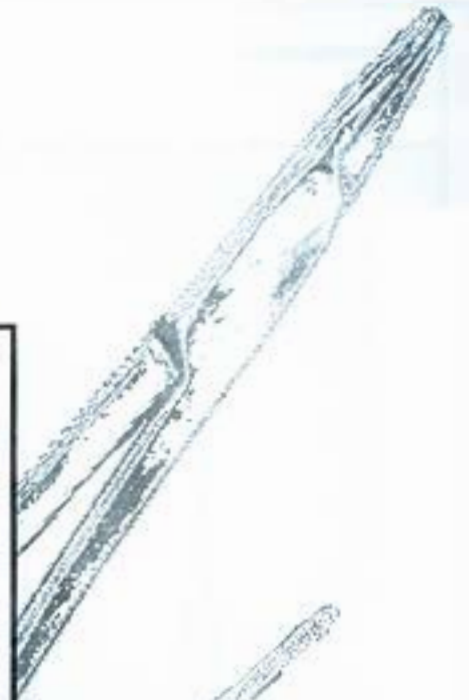
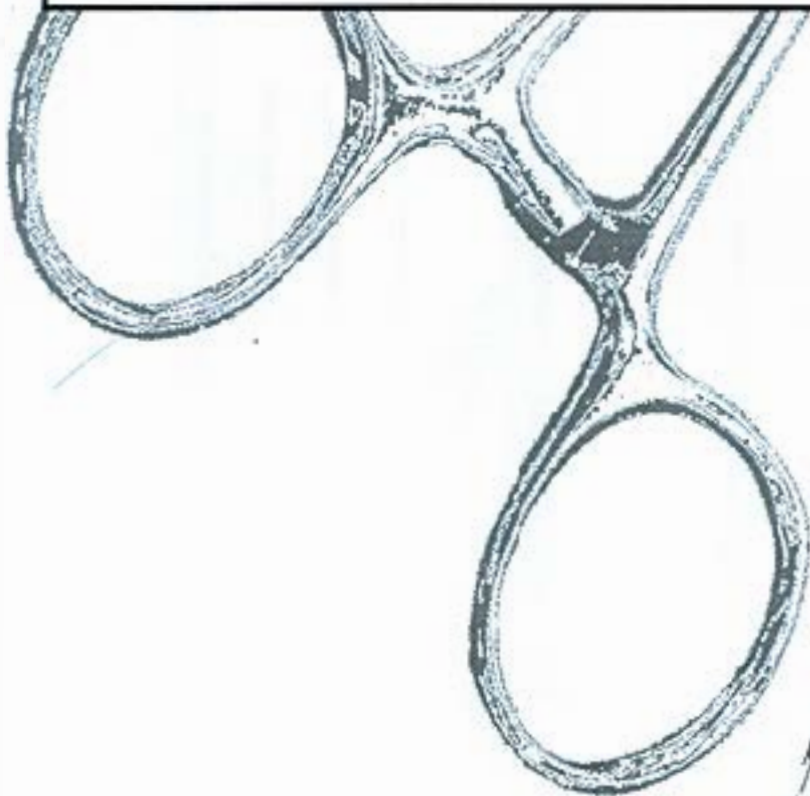
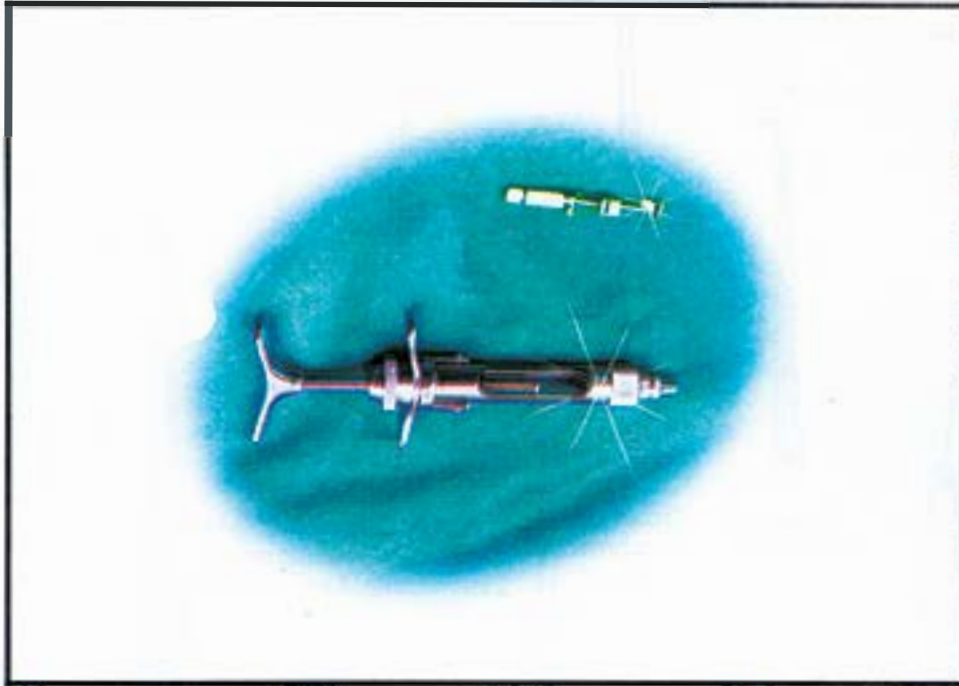

DEPARTMENT NO. 23

FROM  
PAGE#

288

TO  
PAGE#

295

INSTRUMENTS CATEGORY

AMALGAM CARRIERS  
AMALGAMPISTOLEN  
PORTA AMALGAMAS

AMALGAM CARRIERS  
AMALGAMPISTOLEN  
PORTA AMALGAMAS



23-001-00  
Non-Slip  
Amalgam Well



23-002-00  
Amalgam Well



1 P  
23-008-00  
Plastic Tip



2 P  
23-009-00  
Metal Tip



3  
23-010-00  
Metal Tip  
For 23-007-00



3  
23-011-00  
Plastic Tip  
For 23-007-00



23-003-00  
Micro



1/1  
23-004-00

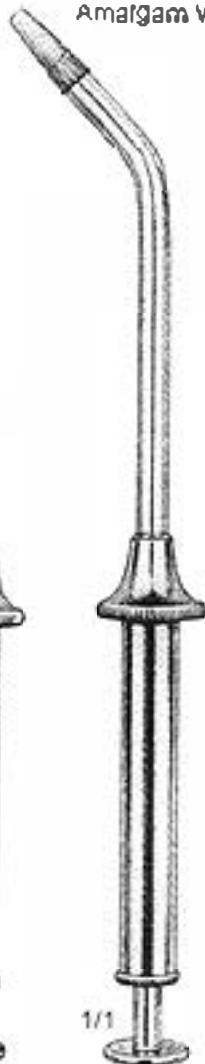

1/1  
23-005-00

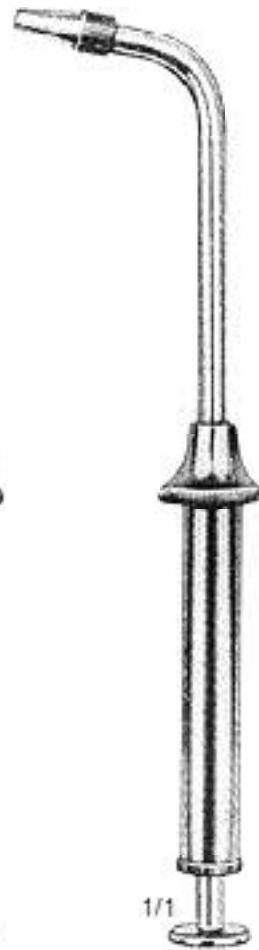

1/1  
23-006-00

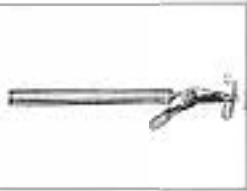

AMALGAM CARRIERS  
 AMALGAMPISTOLEN  
 PORTA AMALGAMAS

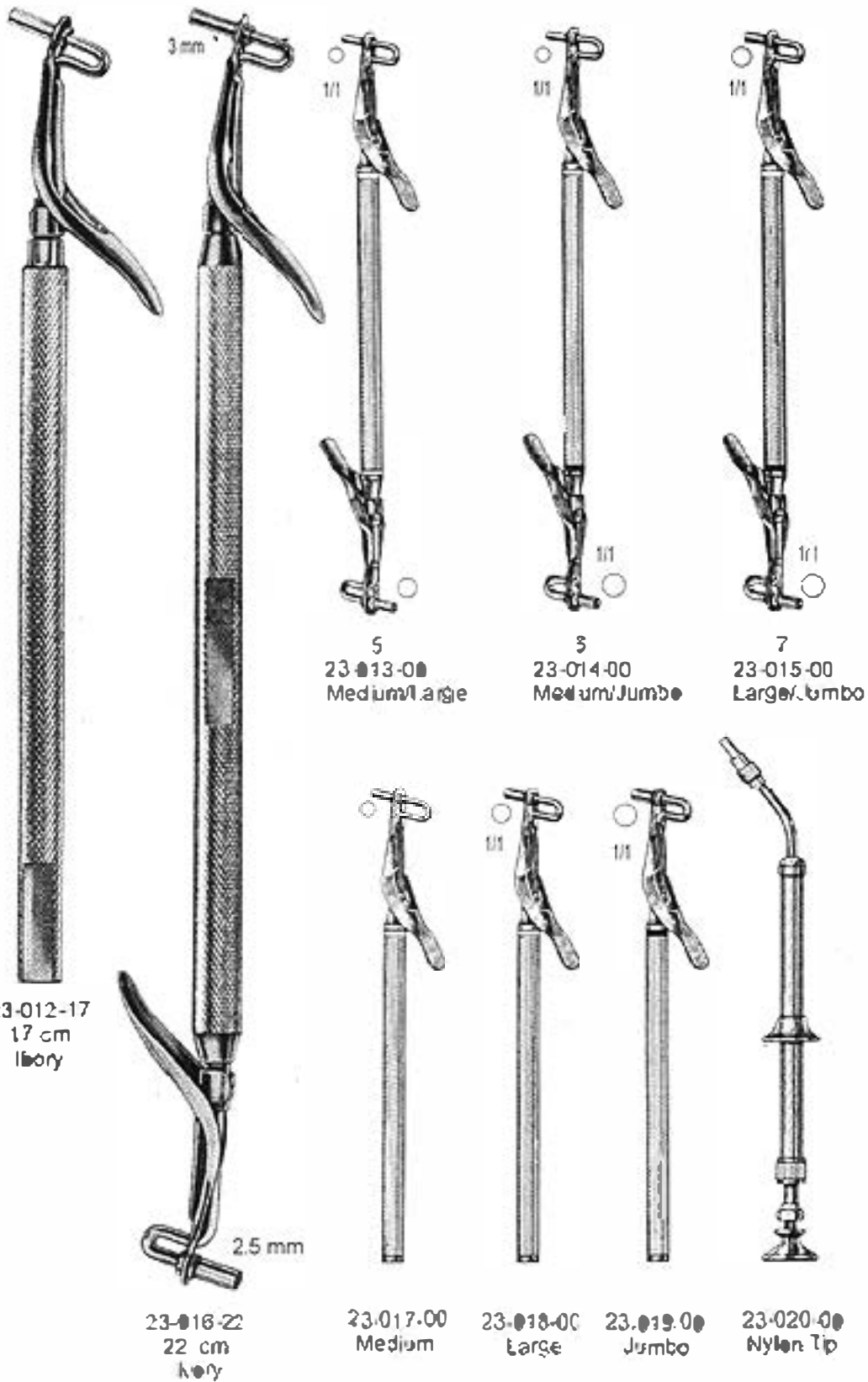

CARTRIDGE SYRINGES  
INJEKTIONSKANULEN  
JERINGAS PARA CARTUCHO

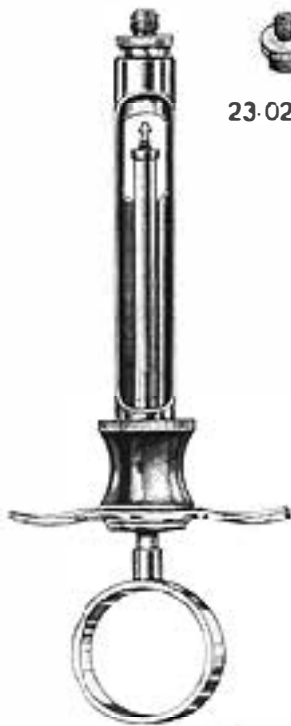

23-023-00

23-121-00 (1.8 ml)  
23-122-00 (2.2 ml)



23-026-00

23-024-00 (1.8 ml)  
23-025-00 (2.2 ml)



23-027-00 (1.8 ml)  
23-028-00 (2.2 ml)



23-031-00  
23-032-00

23-029-00 (1.8 ml)  
23-030-00 (2.2 ml)



23-033-00 (1.8 ml)  
23-034-00 (2.2 ml)



23-035-00 (1.8 ml)  
23-036-00 (2.2 ml)



23-037-00 (1.8 ml)  
23-038-00 (2.2 ml)

Note:- Available Both In European & American.



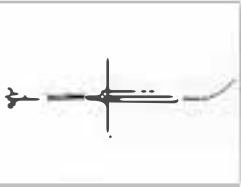

1/2

23-039-00



23 039 01



23 040-00



23 031 01



1/2

23.041.00  
 Without Valve



23.042.00  
 With Valve



11

CARTRIDGE SYRINGES  
 INJEKTIONSKANULEN  
 JERINGAS PARA CARTUCHO



23-043-00 (1.8 ml)  
 23-044-01 (2.2 ml)



23-045-00 (1.8 ml)  
 23-046-01 (2.2 ml)



23-049-00 (1.8 ml)  
 23-048-01 (2.2 ml)



23-051-00 (1.8 ml)  
 23-052-01 (2.2 ml)



23-053-00 (1.8 ml)  
 23-054-01 (2.2 ml)  
 Cork Screw Tip



23-055-00 (1.8 ml)  
 23-056-01 (2.2 ml)



23-057-00 (1.8 ml)  
 23-058-01 (2.2 ml)



CARTRIDGE SYRINGES  
INJEKTIONSKANULEN  
JERINGAS PARA CARTUCHO

23



23-059-00  
INTRALIGAMENTAL SYRINGE (PISTOL Shaped)

294A



## **INTRALIGAMENTAL SYRINGES**



**23-060-00**  
Injects 0.05 ml with every click



**23-061-00**  
Injects 0.05 ml with every click.  
Easy attach / detach luer lock system.  
Angled tip allows easy access to inject in difficult areas.  
Special featured release button.



**23-062-00**  
Injects 0.05 ml with every click.  
Easy attach / detach luer lock system.  
Angled tip allows easy access to inject in difficult areas.



MATRIX RETAINERS  
 MATARIZAN SPANNER  
 PORAMATRICES



23-110-00



23-111-00  
 Junior



23-112-00  
 Senior

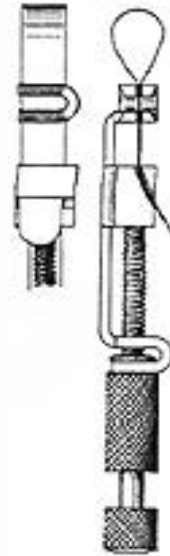

23-113-00  
 Universal  
 Teffiere



23-114-00  
 Ivor 1



23-115-00  
 Ivor 12



1  
 23-116-00



2  
 23-117-00

----- Nystrom -----

Department

24

HANDLES FOR MOUTH MIRRORS  
MUNDSPIEGELGRIFFE  
MANGOS PARA ESPEJOS DE BOCA

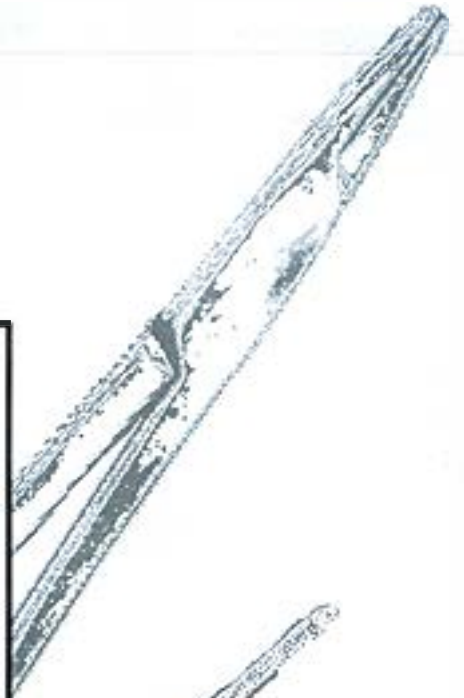
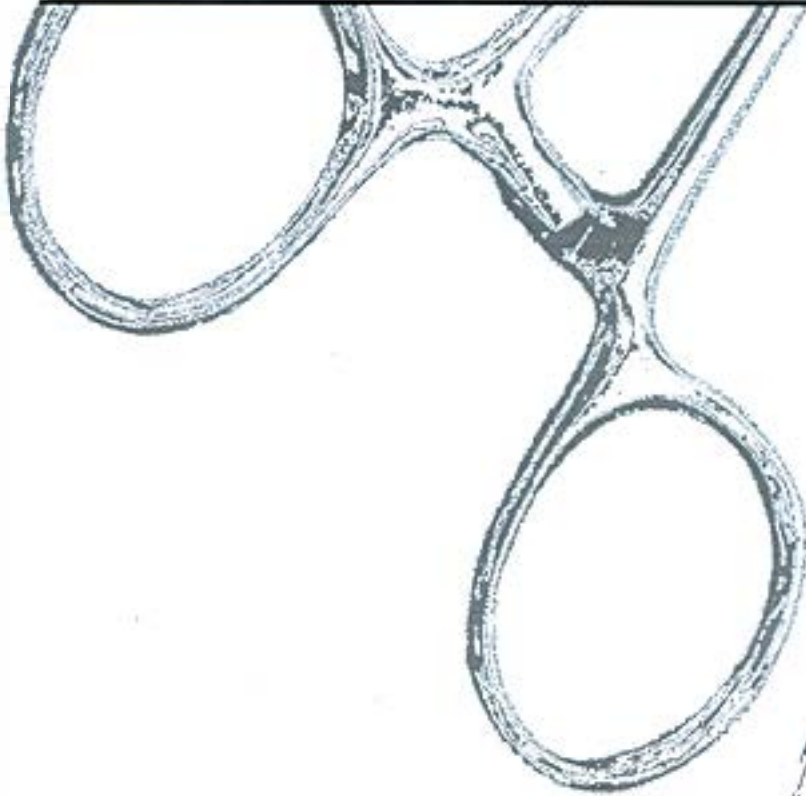
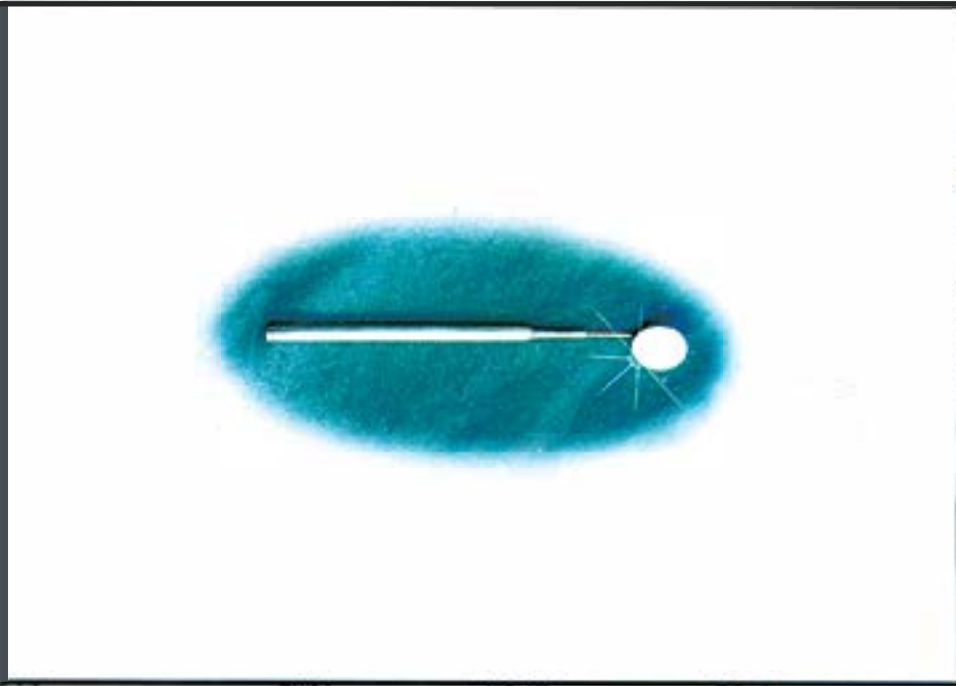

DEPARTMENT NO. 24

---

FROM  
PAGE#

296

TO  
PAGE#

300

INSTRUMENTS CATEGORY

HANDLES FOR MOUTH MIRRORS  
MUNDSPIEGELGRIFFE  
MANGOS PARA ESPEJOS DE BOCA

HANDLES FOR MOUTH MIRRORS  
 MUNDSPIEGELGRIFFE  
 MANGOS PARA ESPEJOS DE BOCA

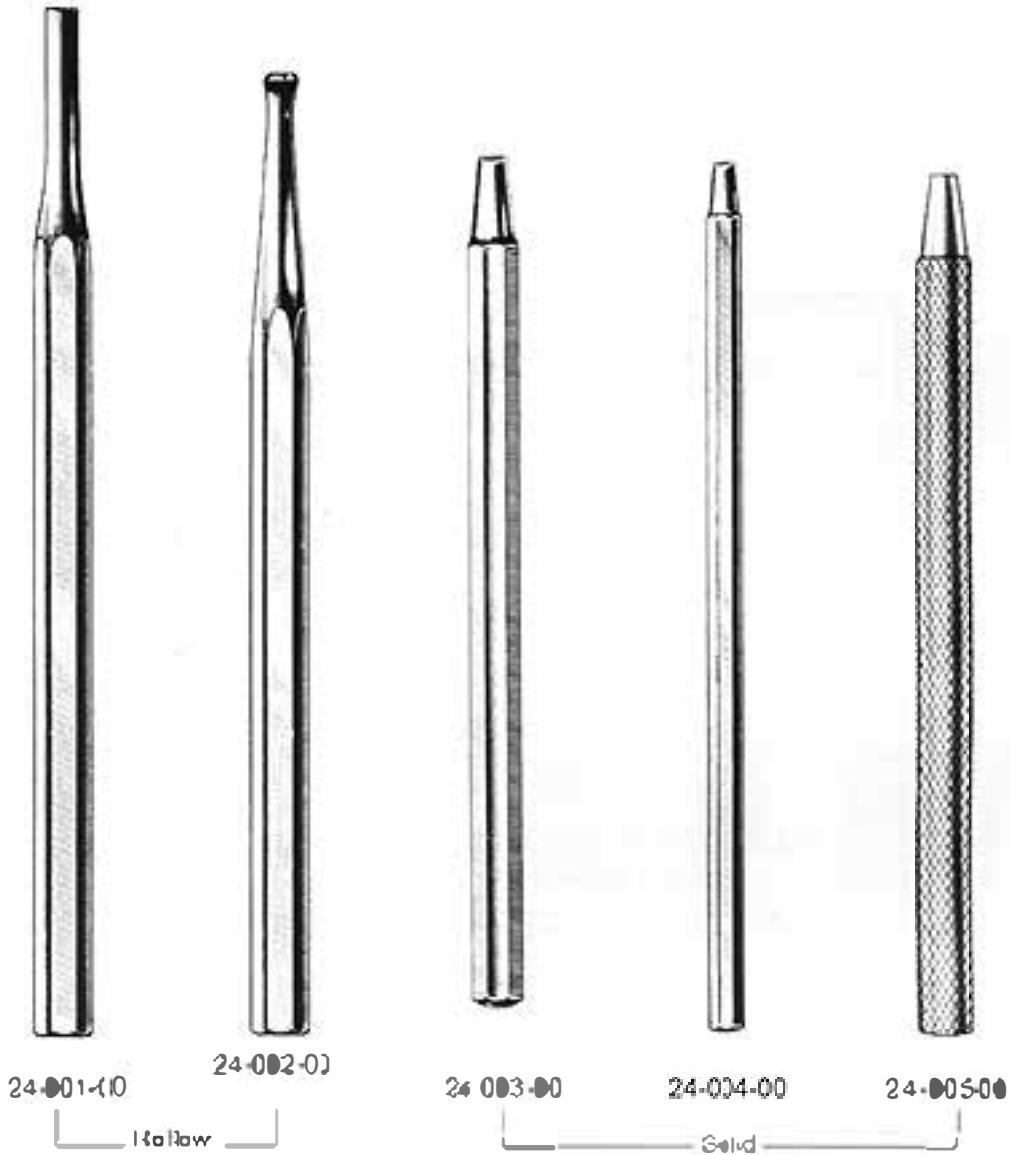
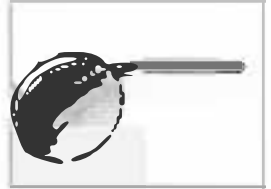

Note:- Available Both In European & American Thread



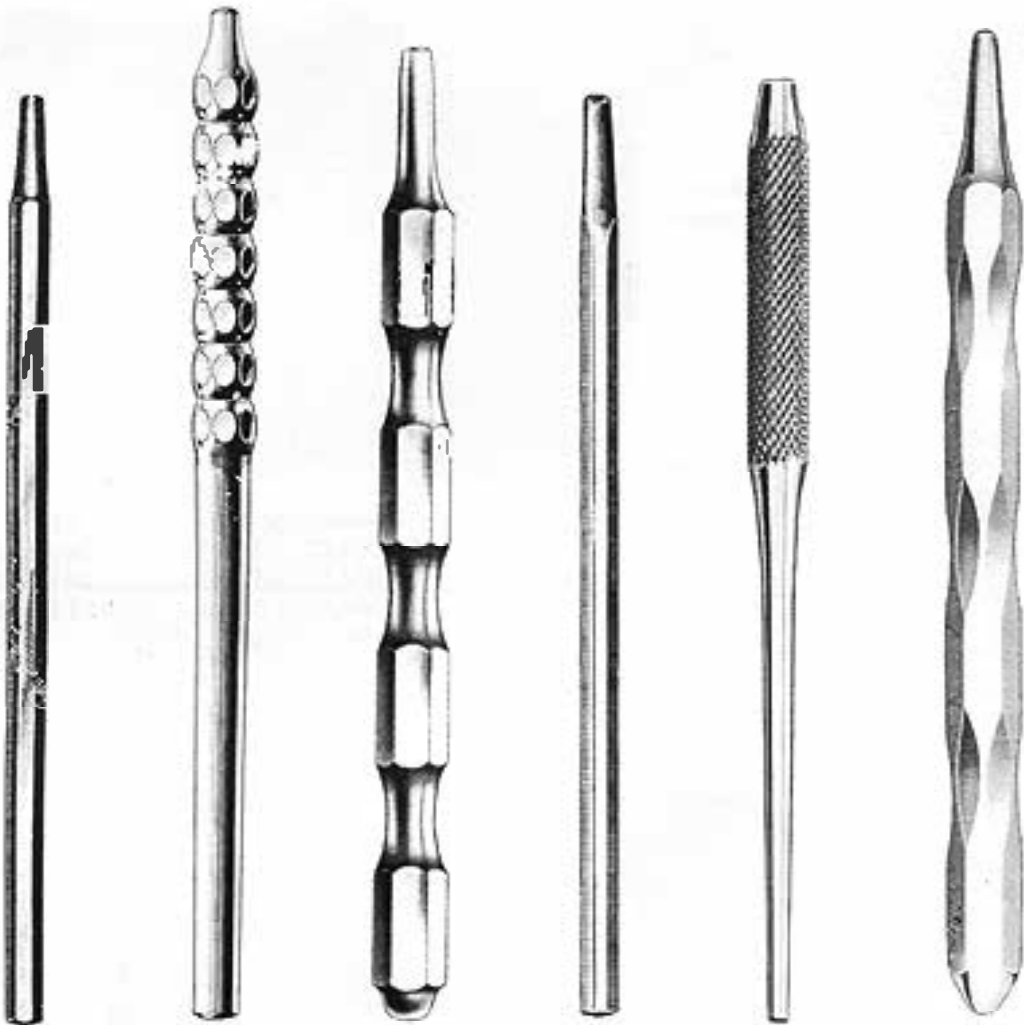

24-006.00  
Solid

24-007.00  
Hollow

24-008.00  
Solid

483  
24-009.00

487 Rs  
24-010.00  
Solid

488 Rs  
24-011.00  
Hollow

Note:- Available Both In European & American Thread

MOUTH MIRRORS  
MUNDSPIEGEL  
ESPEJOS DE BOCA

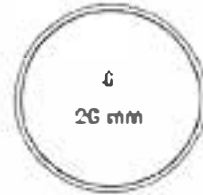

24-052-02 (2 cm)  
24-062-02 (2.2 cm)  
24-062-02 (2.4 cm)  
24-062-02 (2.6 cm)  
Magnifying



24-063-02 (2 cm)  
24-063-02 (2.2 cm)  
24-063-02 (2.4 cm)  
24-063-02 (2.6 cm)  
Plain



24-054-02 (2 cm)  
24-034-02 (2.2 cm)  
24-054-02 (2.4 cm)  
24-054-02 (2.6 cm)  
Magnifying



24-065-02 (2 cm)  
24-065-02 (2.2 cm)  
24-065-02 (2.4 cm)  
24-065-02 (2.6 cm)  
Plain



24-066-02 (2 cm)  
24-066-02 (2.2 cm)  
24-066-02 (2.4 cm)  
24-066-02 (2.6 cm)  
Plain (Frost Surface)  
Rhodium Plated



Department

25

SCALPLE HANDLES  
SKALPELL-GRIFFE  
MANGOS DE BISTURIES

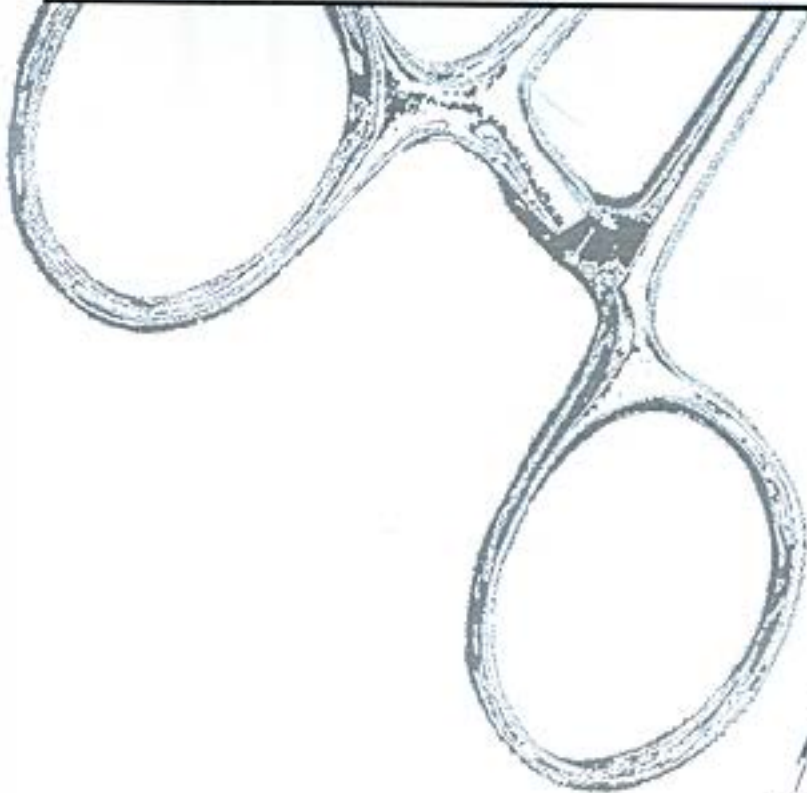

DEPARTMENT NO. 25

---

FROM  
PAGE#

301

TO  
PAGE#

304

INSTRUMENTS CATEGORY

SCALPLE HANDLES  
SKALPELL-GRIFFE  
MANGOS DE BISTURIES



FRET SAWS  
LAUBSAGEBOGAN  
PORTA-SIERRAS

25



25-001-20  
20 cm  
Model Saw

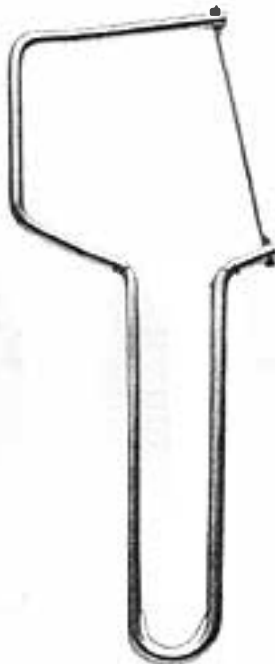

25-002-18  
18 cm  
Bowed  
Model Saw

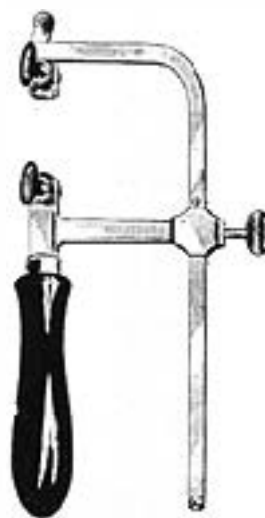

25-003-00  
Fret Saw Frames,  
Adjustable



25-004-00  
Fret Saw Frames,  
Adjustable

SCALPLE HANDLES  
SKALPELL-GRIFFE  
MANGOS DE BISTURIAS

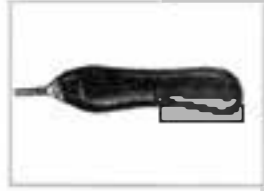

3  
25-055-00



4  
25-058-00

— Bakelite —



4  
25-057-00  
Solid



3L  
25-058-00



3  
25-099-00



3G  
25-080-00



8  
25-061-00



7  
25-062-00

Department

26

HAMMER  
MALLET  
MARTILLOS Y MAZOS

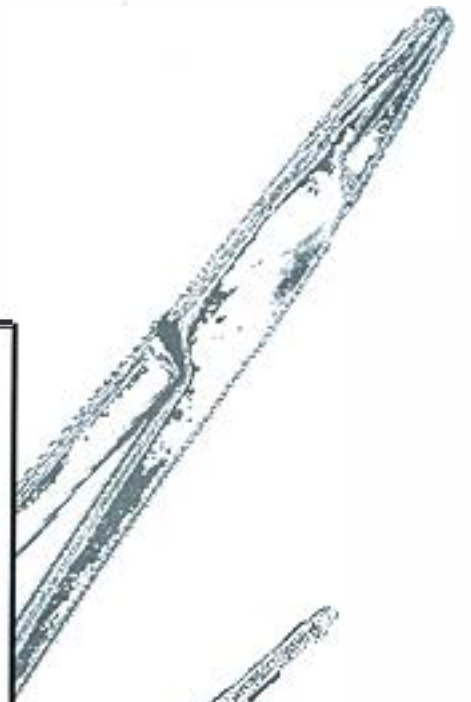
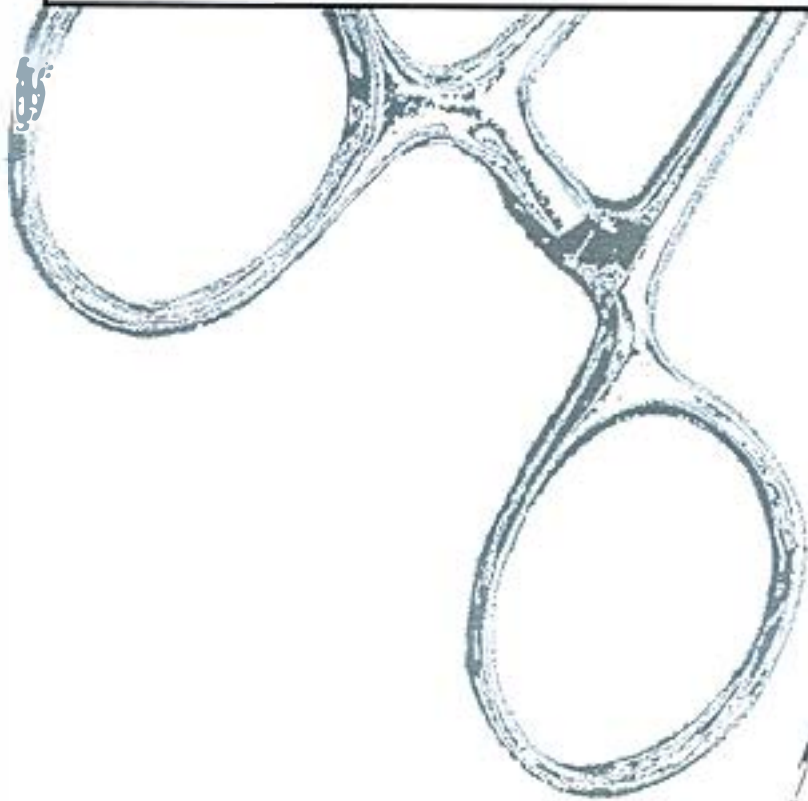
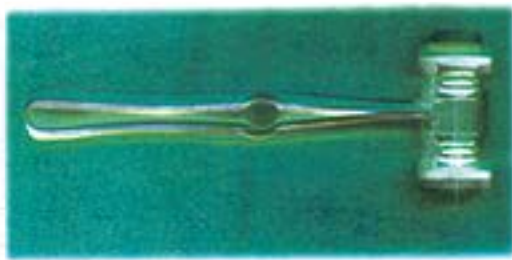

DEPARTMENT NO. 26

---

FROM  
PAGE#

305

TO  
PAGE#

308

INSTRUMENTS CATEGORY

HAMMER  
MALLETS  
MARTILLOS Y MAZOS





HAMMERS  
MALLETs  
MARTILLOS Y MAZOS

26



26-001-22  
22 cm  
Riveting Mallets



26-002-22  
22 cm



26-003-20  
20 cm  
Horn Mallet

307

# HAMMER MALLETS MARTILLOS Y MAZOS

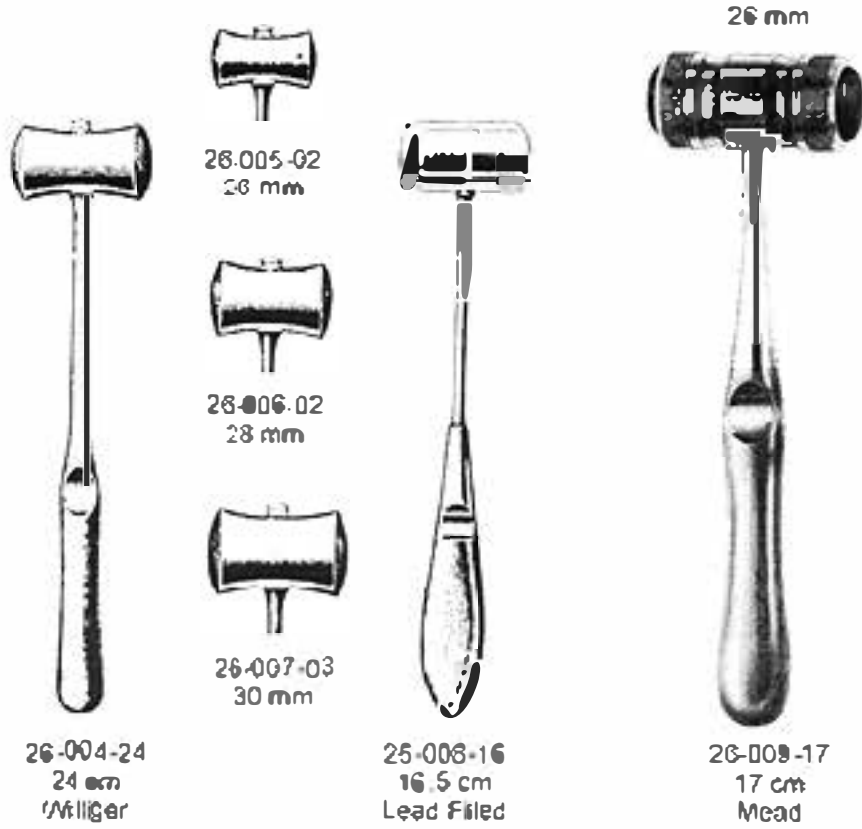
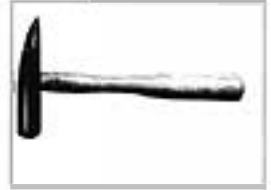

Department

27

CARVING INSTRUMENTS  
MODELLIER INSTRUMENTE  
INSTRUMENTOS PARA MODELAR

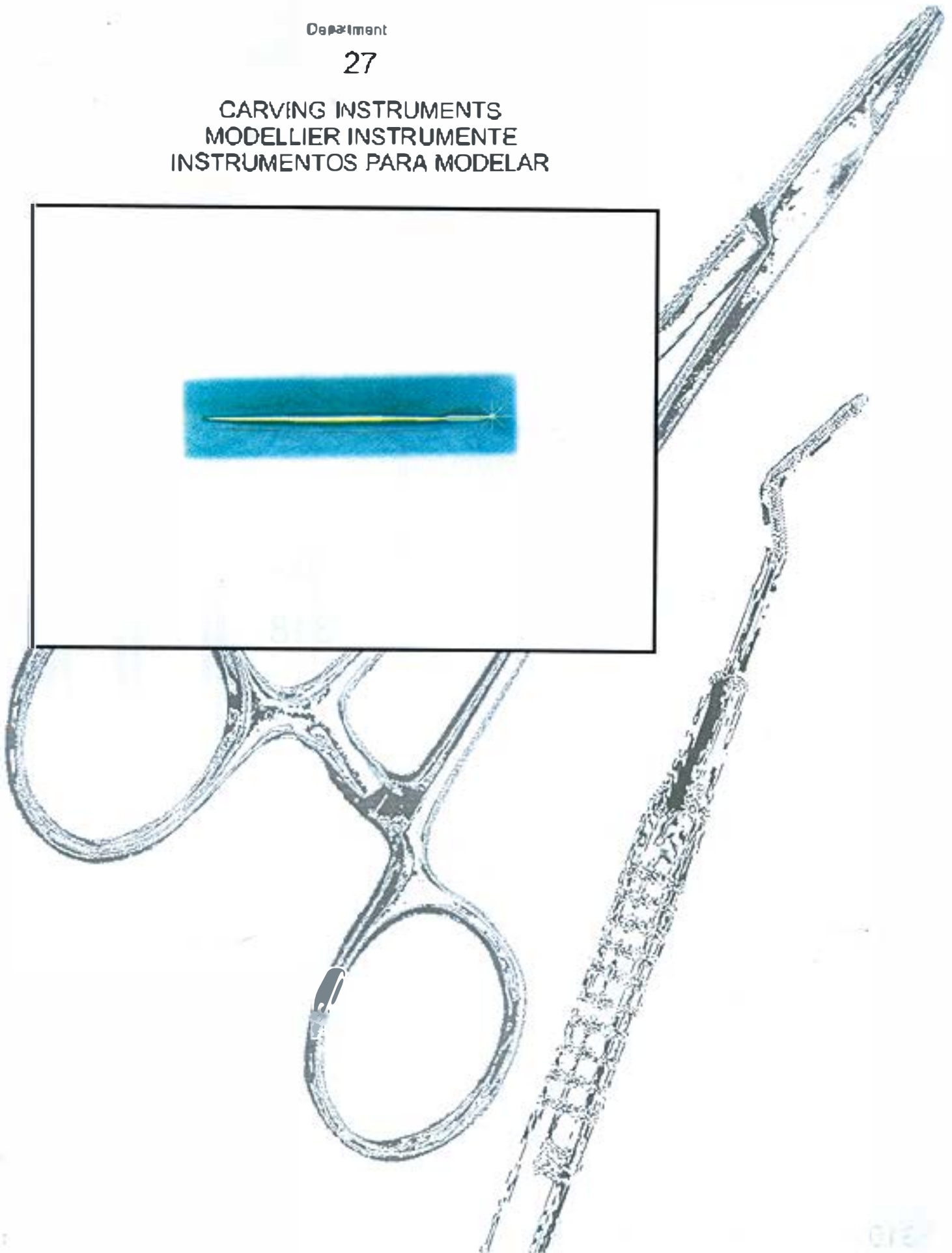
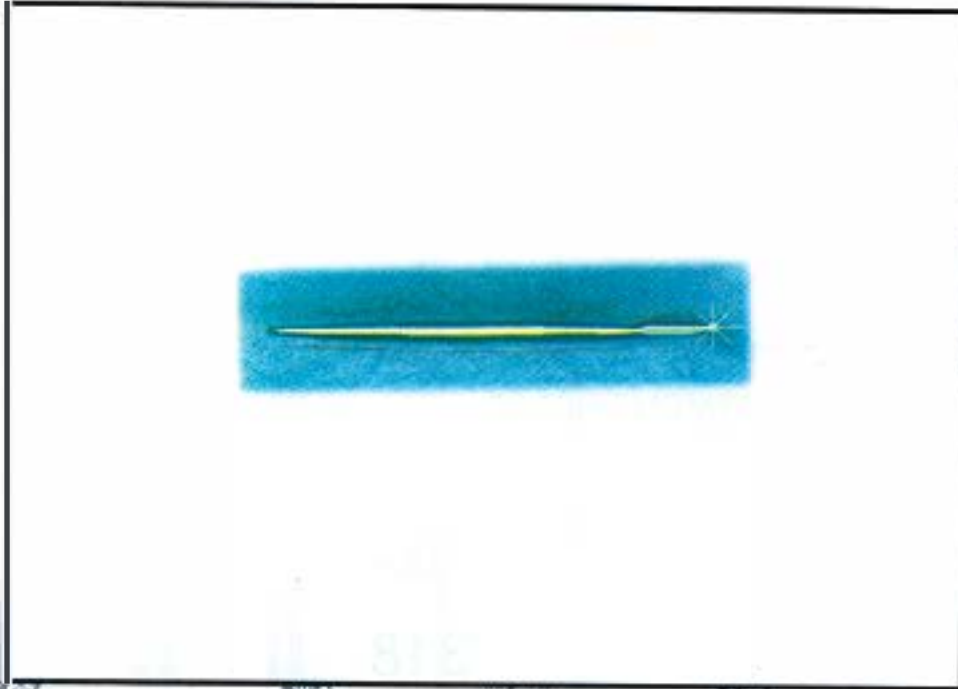

DEPARTMENT NO. 27

---

FROM  
PAGE#

309

TO  
PAGE#

318

INSTRUMENTS CATEGORY

CARVING INSTRUMENTS  
MODELLIER INSTRUMENTE  
INSTRUMENTOS PARA MODELAR

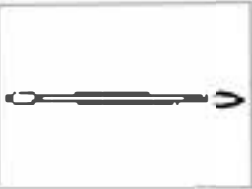

1 2 3  
 1-3  
 27-001-00  
 Mysko  
 27-001-01 27-001-02 27-001-3  
 1 1S 2  
 1-2  
 27-002-00  
 Ward  
 27-002-01 27-002-1S 27-002-02  
 27-003-00  
 Ward  
 27-004-0  
 Baltimore  
 27-004-10  
 Galtman  
 27-005-00  
 Vahé

CARVING INSTRUMENTS  
MODELLIER INSTRUMENTE  
INSTRUMENTOS PARA MODELAR

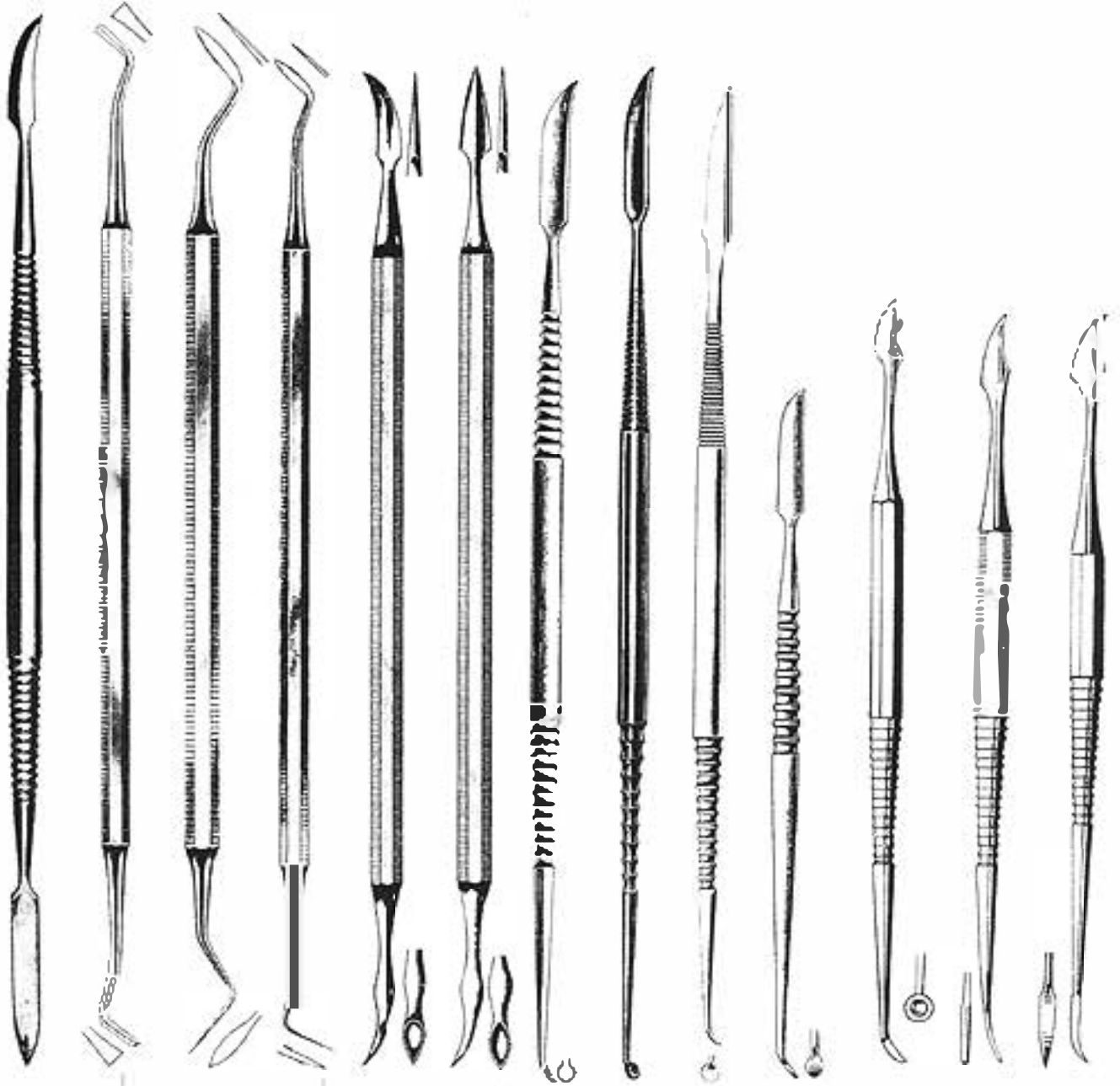

27-006-00  
Reeve  
27-007-00  
Hollenback

27-008-00  
Hollenback  
27-009-00  
Hollenback

27-010-00  
Reach  
27-011-00  
Fisch

27-012-00  
Le Cron  
27-013-00  
Le Cron

27-014-00  
Le Cron  
27-015-00  
Le Cron

27-016-00  
Zahle  
27-017-00  
Zahle

27-018-00  
Zahle



27-019-00  
Hylin



27-020-00  
Hylin-Le Cron



27-021-00  
Hylin-Ceramica



27-022-00  
Hylin



27-023-00



27-024-00  
Le Cron



27-025-00  
Le Cron



27-019-00  
Hylla



27-020-00  
Hyllin-Le Cron



27-021-00  
Hyllin-Ceramica



27-022-00  
Hyllin



27-023-00



27-024-00  
Le Cron



27-025-00  
Le Cron



MODELLING CARVERS  
MODELLIER INSTRUMENTE  
TALLADORES PARA MODELAR

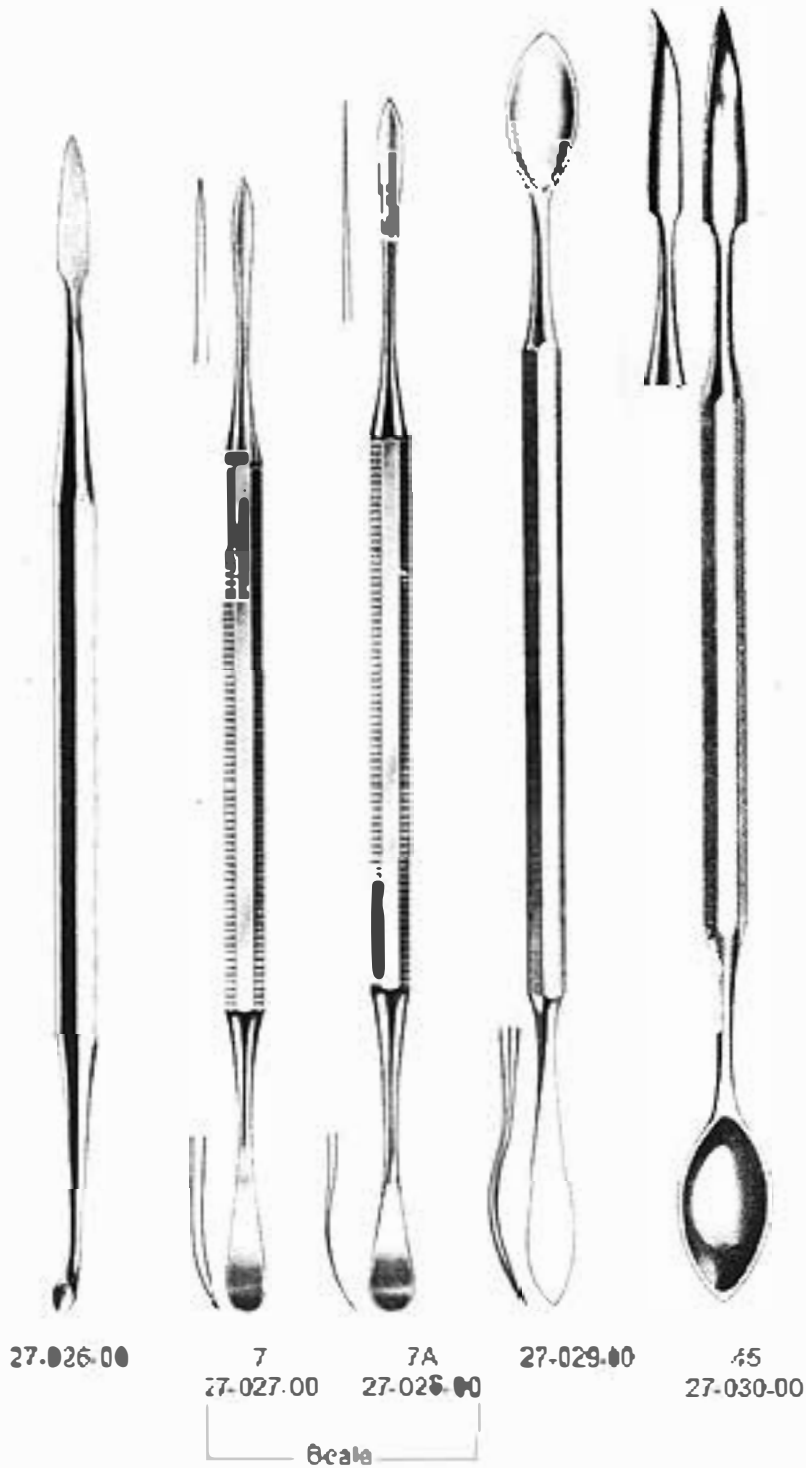

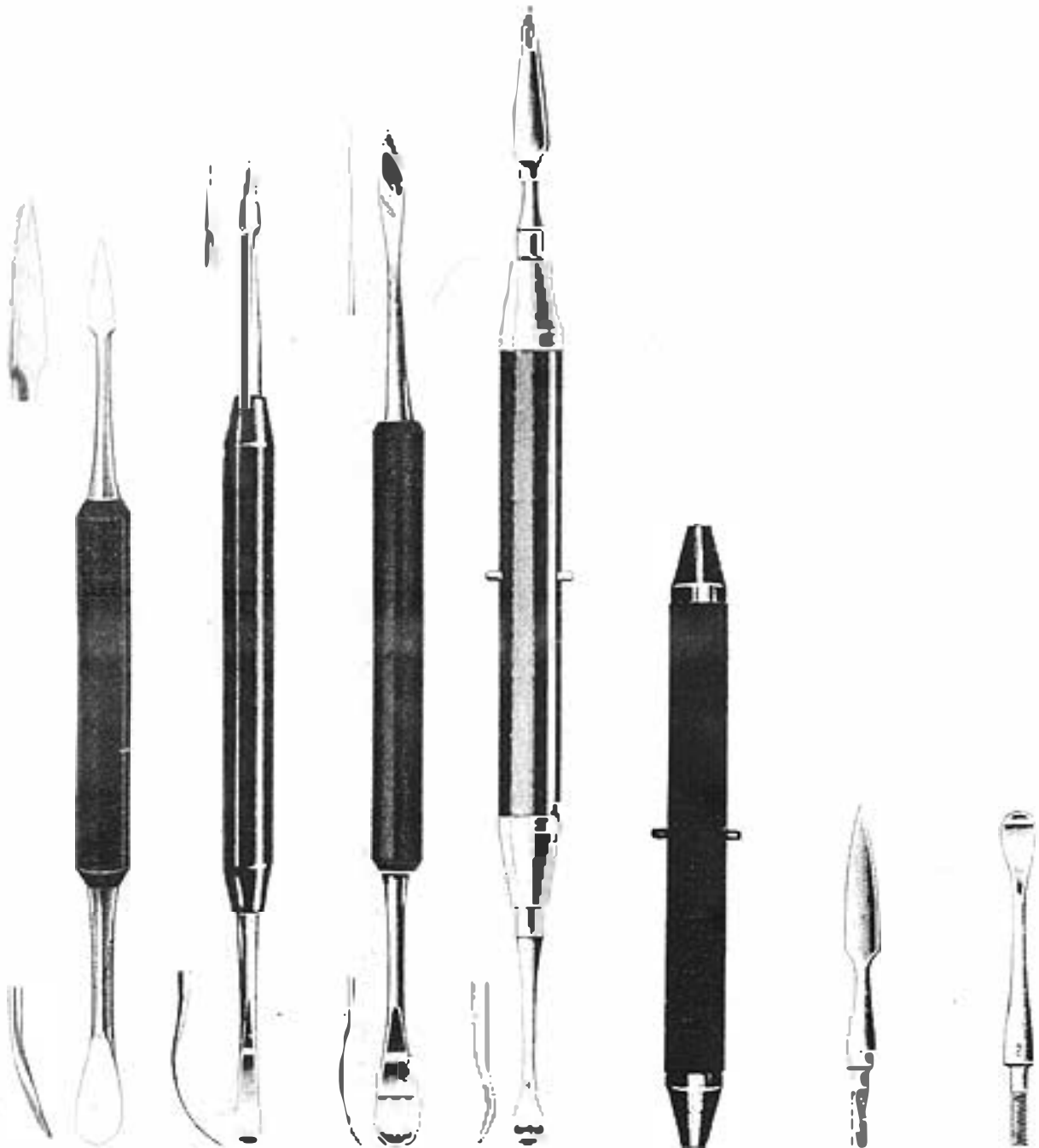

27-031-00  
Taylor

27-032-00  
Falk

27-033-00  
Beale

27-034-00  
Acker

27-035-00  
Handle Only

27-036-00  
Attachment Only

27-037-00  
Attachment Only

CARVING INSTRUMENTS  
MODELLIER INSTRUMENTE  
INSTRUMENTOS PARA MODELAR

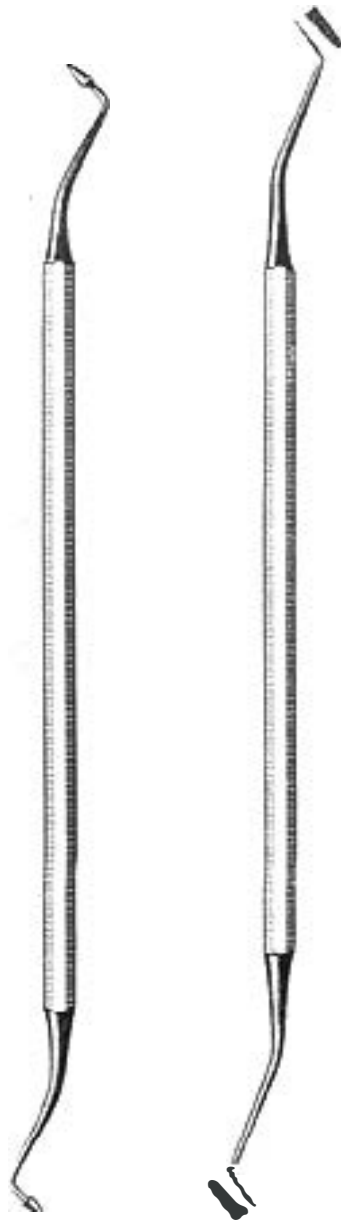

1 2 3 4 5  
37-038 00 37-039 00 37-040 00 37-041-00 37-042-00

- P.K.Thomas

37-043 00 37-065 00 37-046 00 37-047-00 37-048-00

P.K.Thomas



CARVING INSTRUMENTS  
MODELLIER INSTRUMENTE  
INSTRUMENTOS PARA MODELAR

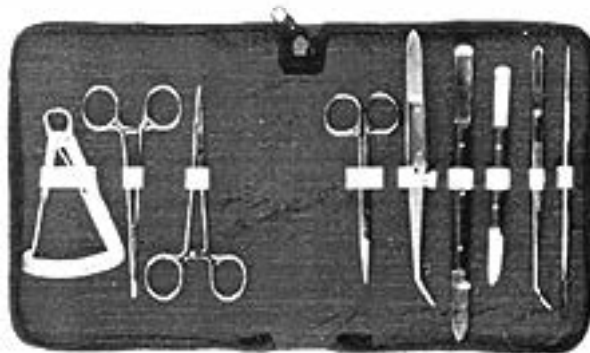

27-049-00  
Modeling Instrument  
Set in Pouch

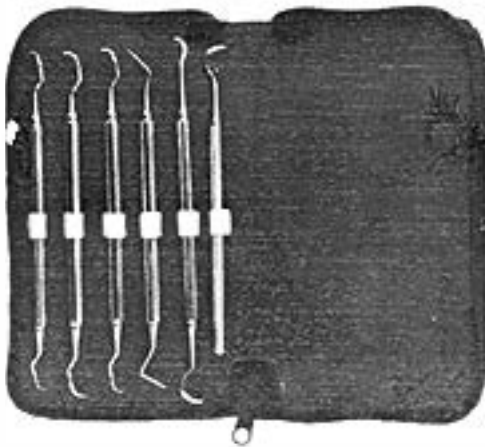

37-050-00  
Modeling Instrument  
Set in Pouch



37-051-00  
Modeling Instrument  
Set in Pouch

CARVING INSTRUMENTS  
MODELLIER INSTRUMENTE  
INSTRUMENTOS PARA MODELAR

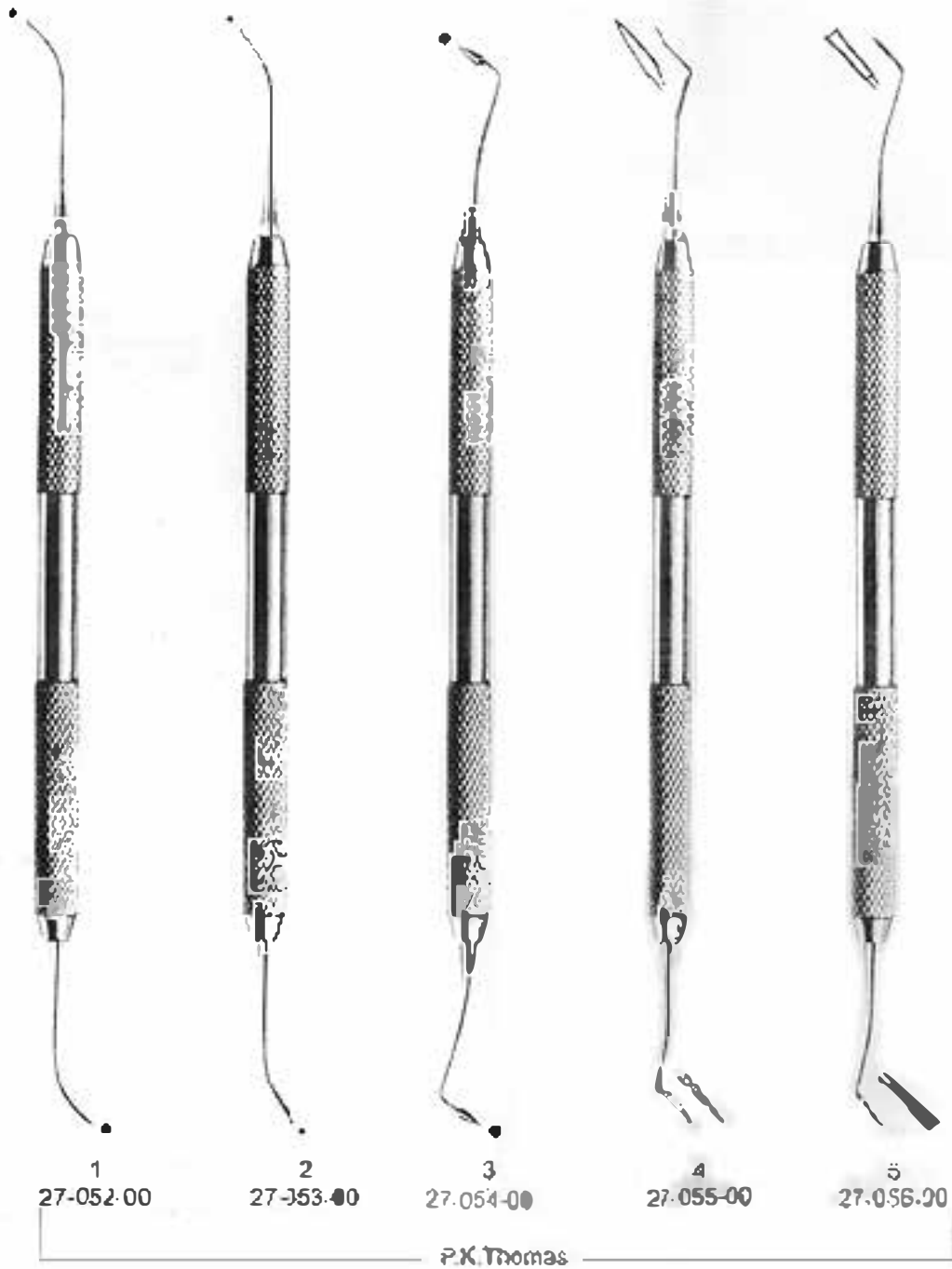



27-058-01



27-059-02

27-057-00



27-061-01



27-062-02

27-060-00



27-064-01



27-065-02

27-063-00



Department

28

WAX KNIVES  
WACHSMESSER  
CUCHILLOS PARA CERA





DEPARTMENT NO. 28

FROM  
PAGE#

319

TO  
PAGE#

331

INSTRUMENTS CATEGORY

WAX KNIVES  
WACHSMESSER  
CUCHILLOS PARA CERA



28.001-13  
13 cm



Fahnenstock



28.002-17  
17.5 cm



28.003-13  
13 cm



Lessmann



28.004-17  
17.5 cm



WAX KNIVES  
WACHSMESSER  
CUCHILLOS PARA CERA



28-005-13  
13 cm



28-006-13  
13 cm



28-007-13  
13 cm



28-008-17  
17 cm



28-009-00



28-010-00

Emert



WAX KNIVES  
WACHSMESSER  
CUCHILLOS PARA CERA

28



28-012-00



28-013-00  
Sach



28-014-00



28-015-00  
Gritman



1/2

28-016-00

ALGinate AND PLASTER SPATULAS  
ALGinate UND GIPSPATEL  
ESPATULAS PARA ALGINATO Y PARA YESO



28-063-00

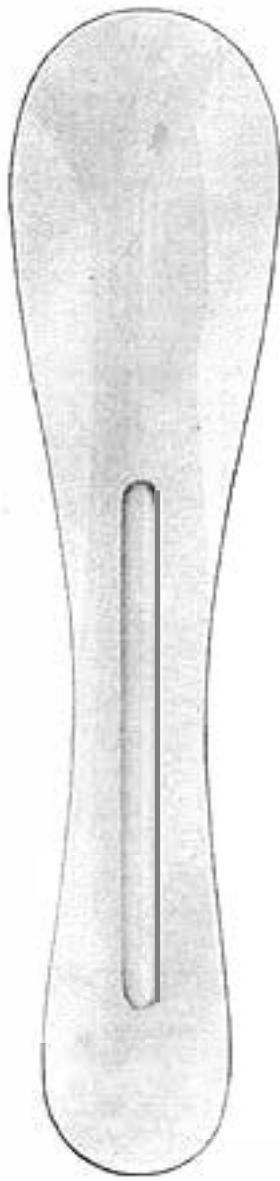

28-064-00  
Lichtenstein



28-065-00  
Flexibel



28-066-00



28-067-30  
Flexibel



ALGINATE AND PLASTER SPATULAS  
ALGINATE UND GIPSPATEL  
ESPATULAS PARA ALGINATO Y PARA YESO

28



28-088-18  
18.5 cm



28-089-19  
19.5 cm



28-070-21  
21.5 cm



28-071-20  
20.5 cm

PLASTER CUTTING FORCEPS  
GIPSSCHNEIDE UND GIPSBRUCHZANGE  
ALICATE PARA YESO

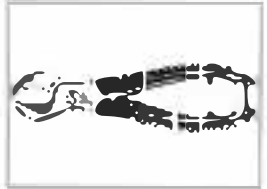

28-122-00



28-123-00



28-124-00

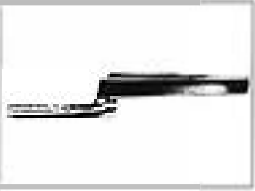

28-165-15  
15 cm



28-166-15  
15 cm  
Miller



28-167-15  
15 cm

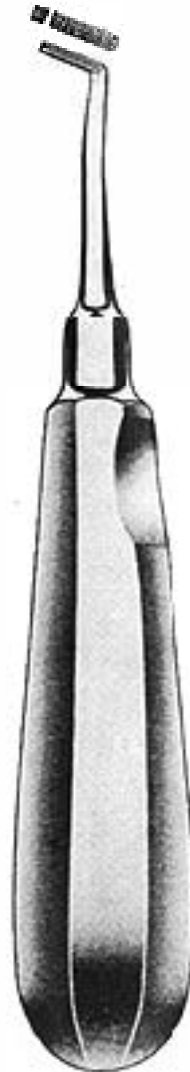

28-168-00  
Mershon



1/1

28-169-00



1/1

28-170-00  
Steiner



ARTICULATORS  
ARTIKULATOREN  
ARTICULADORES



28-220-00  
Full Arch  
Chrome Plated



28-221-00  
Denture  
Chrome Plated



28-222-00



28-223-00  
Crowned Bridge  
Chrome Plated



28-224-00  
Full Denture  
Chrome Plated



28-225-00

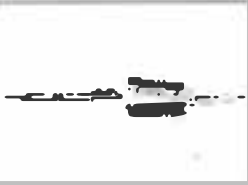

**SOLDERING TWEEZERS  
LOTPINZETTEN  
PINZAS PARA SOLDAR**



28-275-16  
16 cm

28-276-16  
16 cm

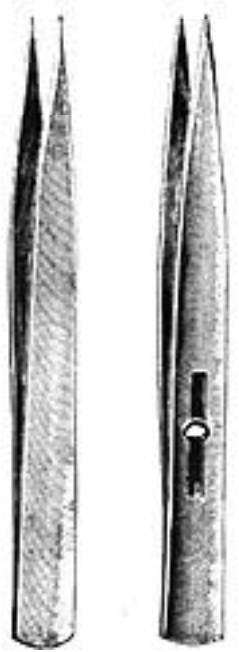

28-277-12  
28-278-16  
12 cm  
16 cm

28-279-12  
28-280-16  
12 cm  
16 cm

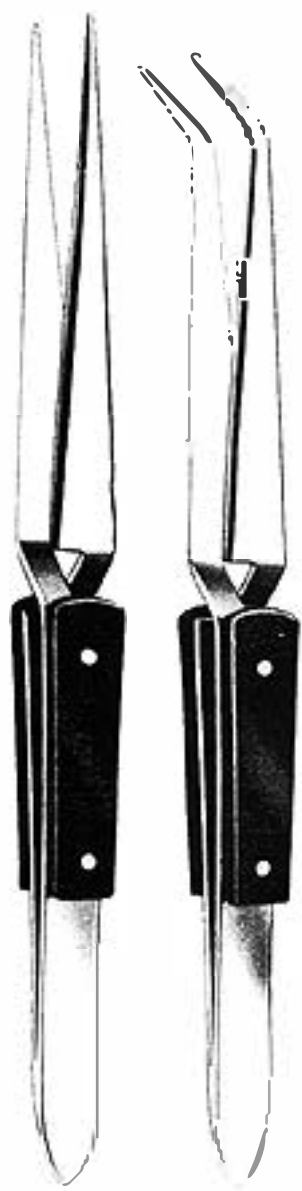

28-281-10  
10.5 cm



28-282-10  
10.5 cm



28-283-16  
16 cm



28-284-16  
16 cm

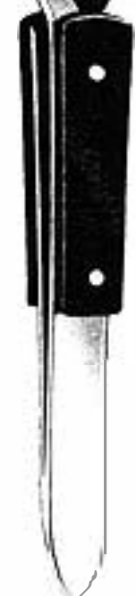

28-285-16  
16 cm



28-286-16  
16 cm

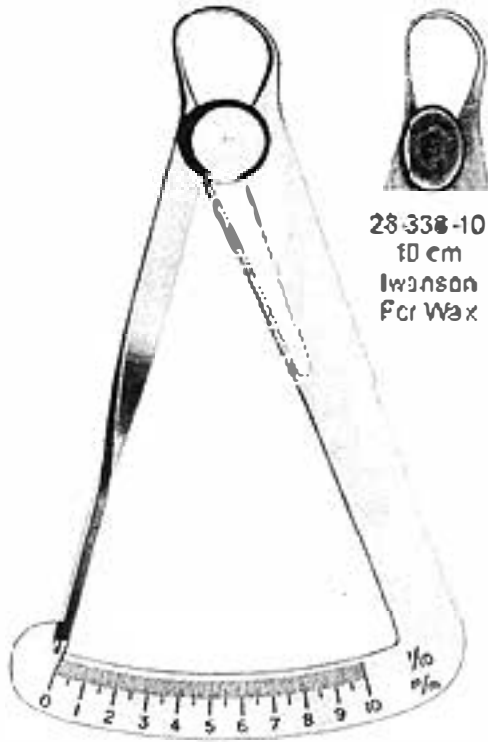

28-338-10  
10 cm  
Invarson  
For Wax

28-337-10  
10 cm  
Invarson  
For Metal



28-339-10



28-340-00  
Boley

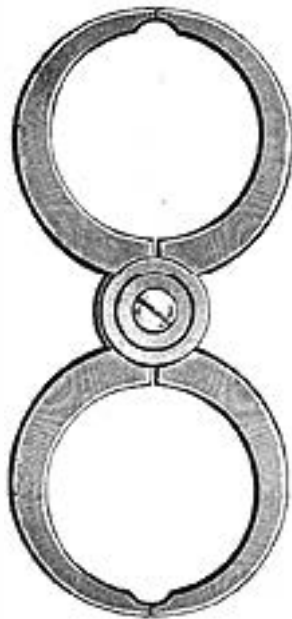

28-341-00



28-342-00  
Estadonk



28-343-00

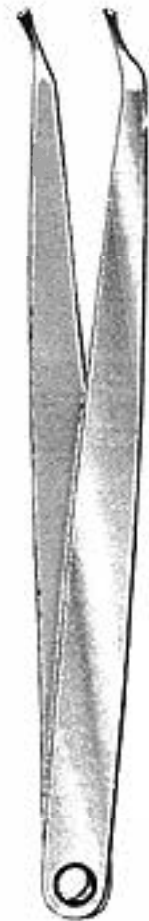

28-344-00  
Korbi

Department

29

STAINLESS STEEL IMPRESSION TRAYS  
ABDRUCKLOFFEL AUS EDELSTAHL  
CUBETAS PARA DE ACERO INOXIDABLE

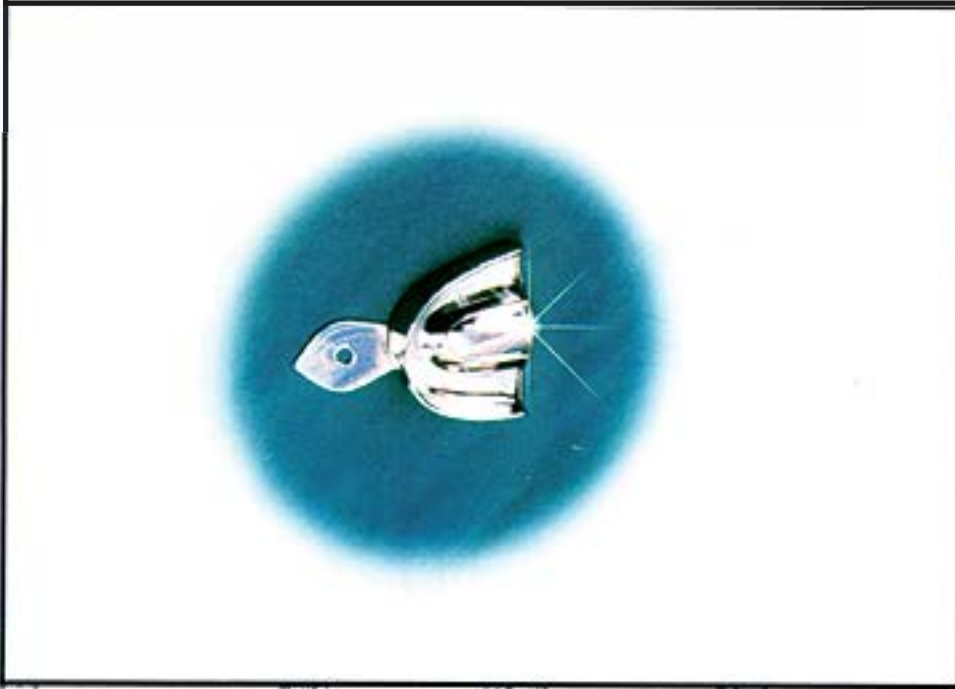

**Uppers**

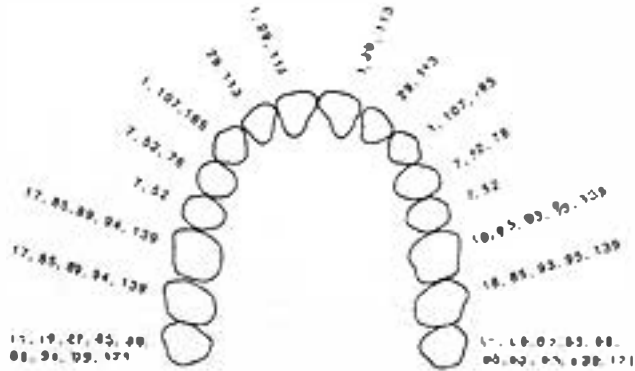

**ADULTS**

**Lowars**

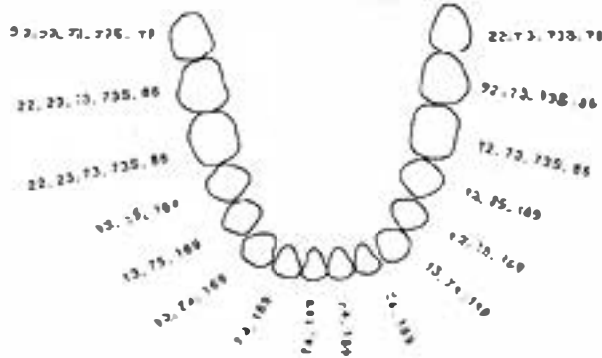

**Children's Uppers**

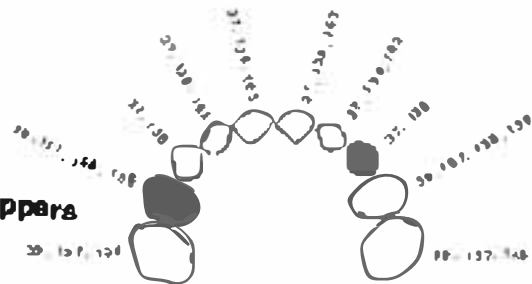

**CHILDREN**

**Children's Lowars**

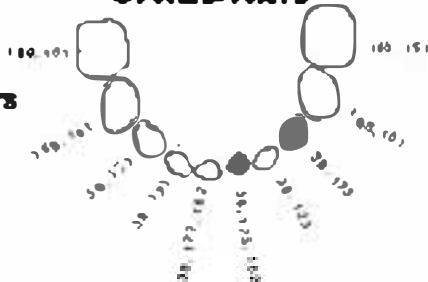

STAINLESS STEEL IMPRESSION TRAYS  
 ABDRUCKLOFFEL AUS EDELSTAHL  
 CUBETAS PARA DE ACERO INOXIDABLE



**SUPER ( Rim Lock )**

29-001.00

→ Set of 10 pieces

Numbers	Size	mm.	mm.
29-001-U1	XL	81	63
29-002-U2	L	74	60
29-003-U3	M	71	55
29-004-L5	NM	67	53
29-005-L4	S	65	51

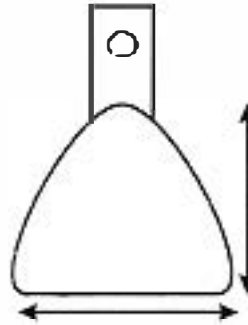

Numbers	Size	mm.	mm.
29-006-L1	XL	80	63
29-007-L2	L	78	59
29-008-L3	M	76	57
29-009-L4	NM	72	57
29-010-L5	S	69	50

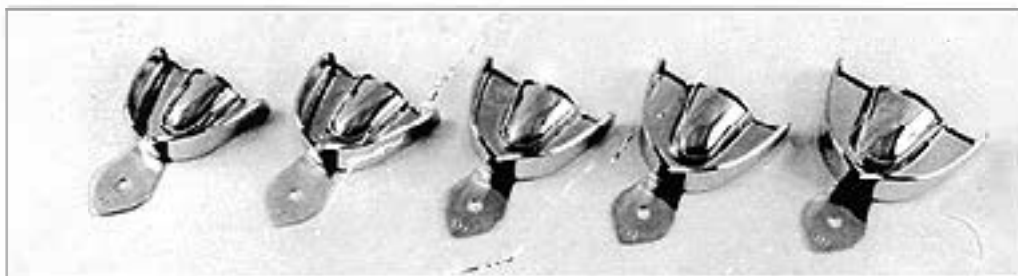
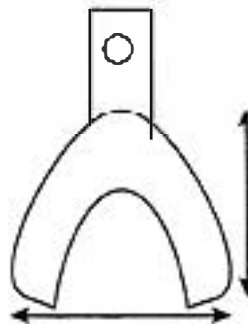

29-005-U5    29-004-L4    29-003-U3    29-002-U2    29-001-U1

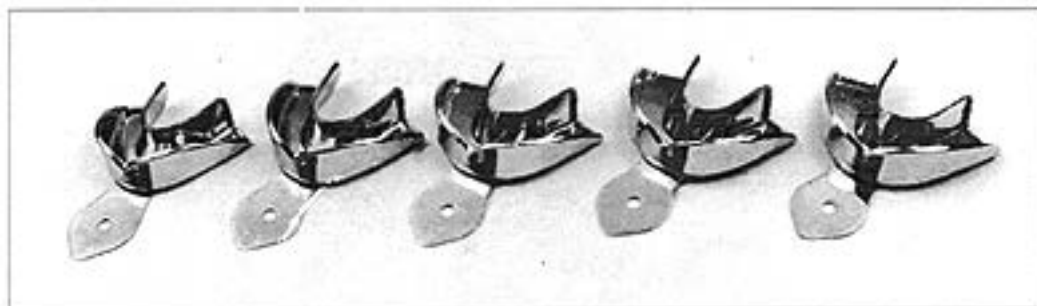

29-010-L5    29-009-L4    29-008-L3    29-007-L2    29-006-L1



STAINLESS STEEL IMPRESSION TRAYS  
 ABDRUCKLOFFEL AUS EDELSTAHL  
 CUBETAS PARA DE ACERO INOXIDABLE

**REGULAR ( Rim Lock )**

29-002-00

→ Set of 10 pieces

Numbers	Size	mm.	mm.
29-011-U1	XXS	61	47
29-012-U2	XS	64	51
29-013-U3	S	66	53
29-014-U4	M	69	57
29-015-U5	L	71	60
29-016-U6	XL	73	62

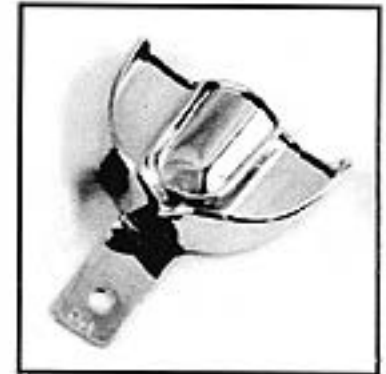
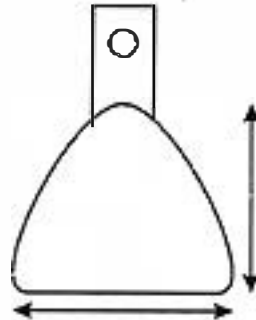

Numbers	Size	mm.	mm.
29-017-L1	XXS	55	47
29-018-L2	XS	60	49
29-019-L3	S	72	54
29-020-L4	M	75	57
29-021-L5	L	76	59
29-022-L6	XL	78	61

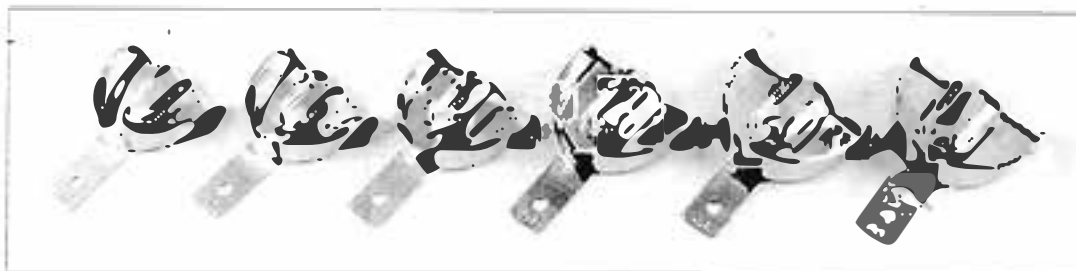
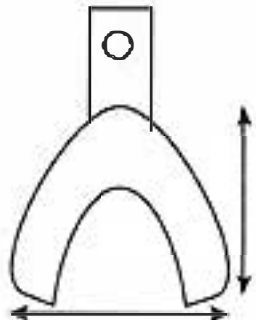

29-011-U1   29-012-U2   29-013-U3   29-014-U4   29-015-U5   29-016-U6



29-017-L1   29-018-L2   29-019-L3   29-020-L4   29-021-L5   29-022-L6



STAINLESS STEEL IMPRESSION TRAYS  
 ABDRUCKLOFFEL AUS EDELSTAHL  
 CUBETAS PARA DE ACERO INOXIDABLE



## Crown and bridge work Impression trays STAINLESS STEEL

**29-003.00**  
 Set of 6 pieces

Number	Size
29-023-L6D	S
29-024-L4D	M
29-025-L2D	L
29-026-L6S	S
29-027-L4S	M
29-028-L2S	L

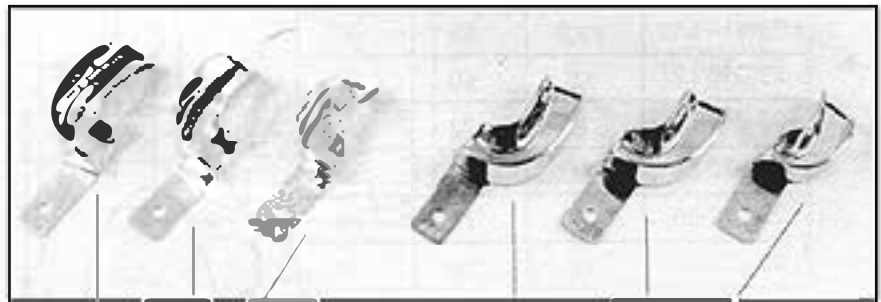

29-025-L2D  
 29-024-L4D  
 29-023-L6D

29-028-L2S  
 29-027-L4S  
 29-026-L6S

Number	Size
29-029-L1P	S
29-30-U1P	S



29-029-L1P 29-30-U1P



STAINLESS STEEL IMPRESSION TRAYS  
 ABDRUCKKLOFFEL AUS EDELSTAHL  
 CUBETAS PARA DE ACERO INOXIDABLE

**29-004.44**

Set of 12 Pieces (Without Rim Lock)

Numbers	Size	mm.	mm.
29-031-U1	XXS	61	47
29-032-U2	XS	64	51
29-033-U3	S	68	53
29-034-U4	M	69	57
29-035-U5	L	71	60
29-035-U6	XL	73	62

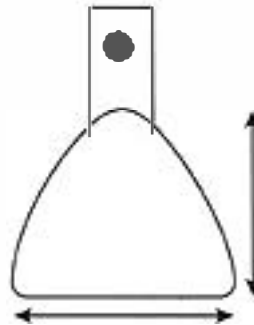

Numbers	Size	mm.	mm.
29-037-L1	XXS	55	47
29-038-L2	XS	60	49
29-039-L3	S	72	54
29-040-L4	M	74	57
29-041-L5	L	76	59
29-042-L6	XL	78	61

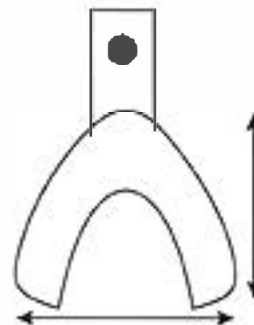

29-031-U1    29-032-U2    29-033-U3    29-034-U4    29-035-U5    29-035-U6

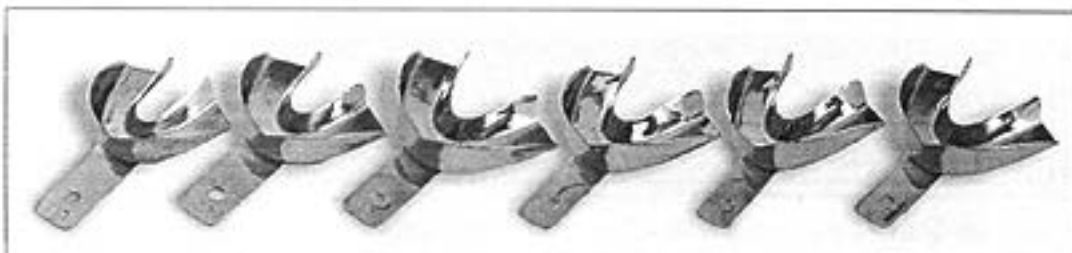

29-037-L1    29-038-L2    29-039-L3    29-040-L4    29-041-L5    29-042-L6



## DEPRESSED ANTERIOR ( Rim Lock )

**29-005-00**  
 Set of 6 pieces

Number	Size	mm.	mm.
29-043-U1	L	81	67
29-044-U4	M	71	64
29-045-U7	S	70	57

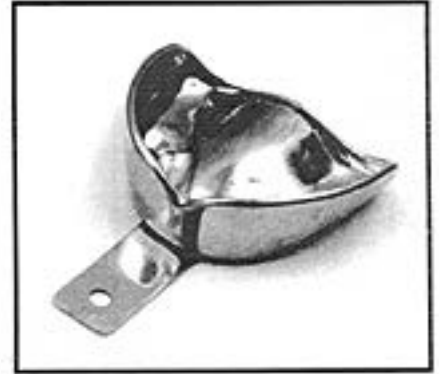
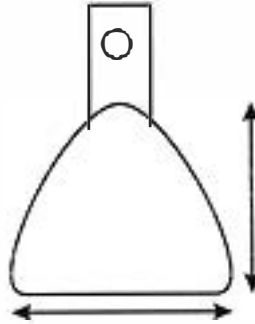

Number	Size	mm.	mm.
29-046-L20	L	81	60
29-047-L21	M	79	57
29-048-L22	S	76	56

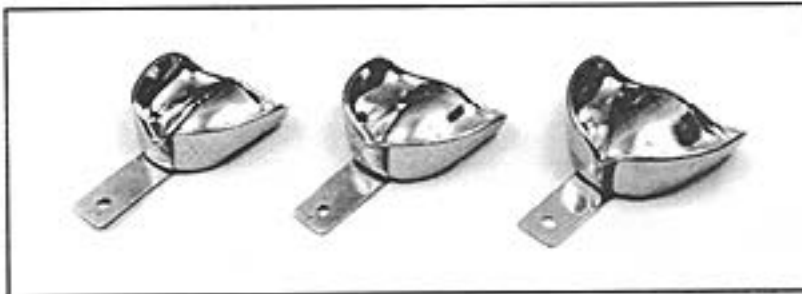
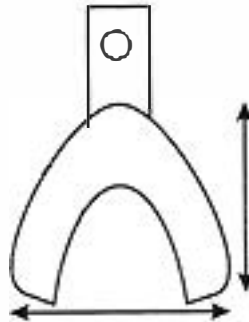

29-045-U7

29-044-U4

29-043-U1

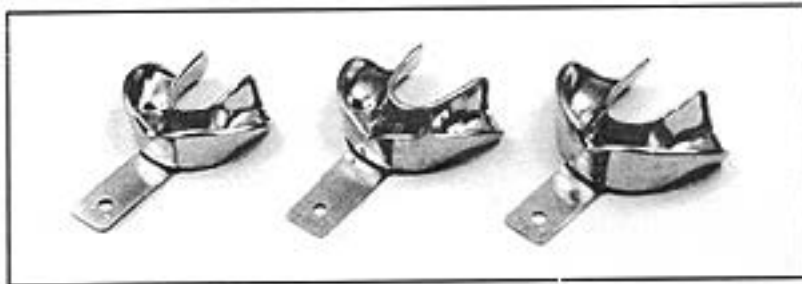

29-048-L22

29-047-L21

29-046-L20



STAINLESS STEEL IMPRESSION TRAYS  
 ABDRUCKKLOFFEL AUS EDELSTAHL  
 CUBETAS PARA DE ACERO INOXIDABLE

**DENTURE / EDENTOLOUS**

**29-006-00**

Set of 8 pieces



Number	Size	mm.	mm.
29-049-U61	L	79	70
29-050-U62	M	76	67
29-051-U63	NM	70	64
29-052-U64	S	73	60

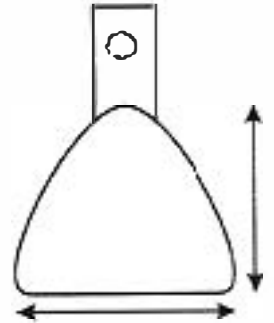

Number	Size	mm.	mm.
29-063-L66	L	86	64
29-064-L67	NL	70	64
29-055-L68	M	73	60
29-056-L69	S	70	57

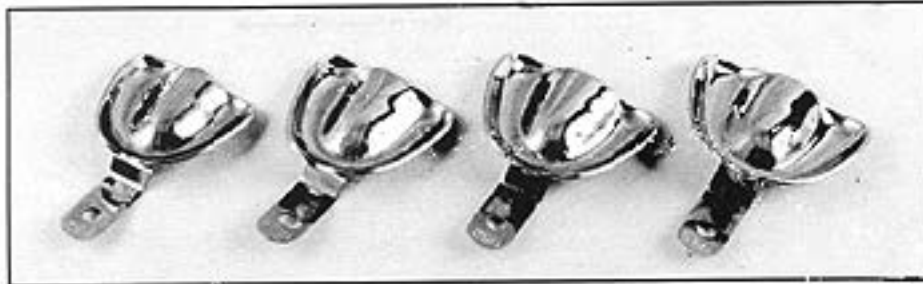
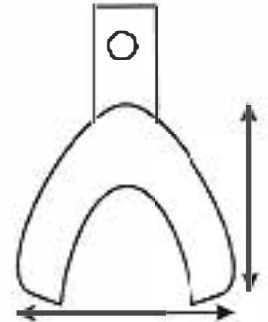

29-052-U64

29-051-U63

29-050-U62

29-049-U61

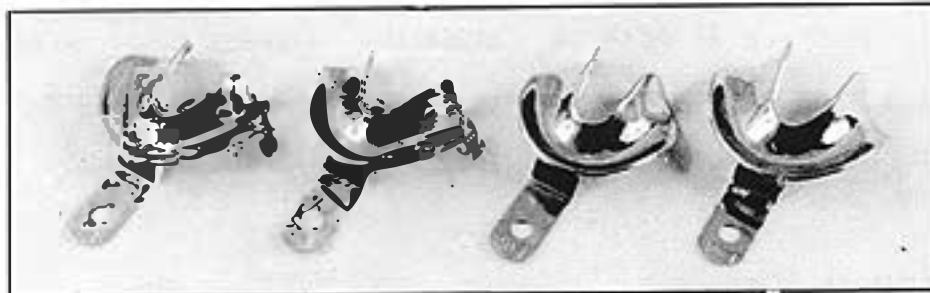

29-056-L69

29-055-L68

29-054-L67

29-053-L66



## REGULAR ( Rim Lock )

29-007.44

Set of 6 Pieces

### UPPER

Numbers	Size	mm.	mm.
29-057-U1	S	55	41
29-059-U2	M	62	46
29-059-U3	L	63	48

### LOWER

Numbers	Size	mm.	mm.
29-060-L1	S	55	44
29-061-L2	M	63	52
29-062-L3	L	69	56

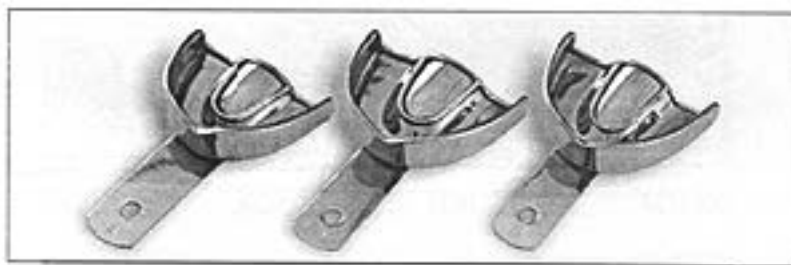
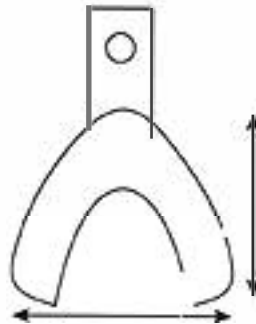
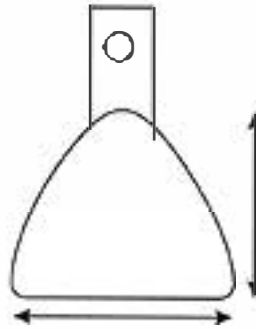

29-057-U1

29-059-U2

29-059-U3



29-060-L1

29-061-L2

29-062-L3



STAINLESS STEEL MPRESS ON TRAYS  
 ABDRUCKLOFFEL AUS EDELSTAHL  
 CUBETAS PARA DE ACERO INOXIDABLE

29

## SUPPER ( Rim Lock )

29 008.44  
 Set of 10 Pieces



Numbers	Size	mm.	mm
29-166 U1	XL	81	63
29-167 U2	L	74	60
29-168 U3	M	71	55
29-169 U4	NM	67	53
29-170 L5	S	65	51

Numbers	Size	mm	mm
29-171 L1	XL	80	63
29-172 L2	L	78	59
29-173 L3	M	76	57
29-174 L4	NM	72	57
29-175 L5	S	69	50

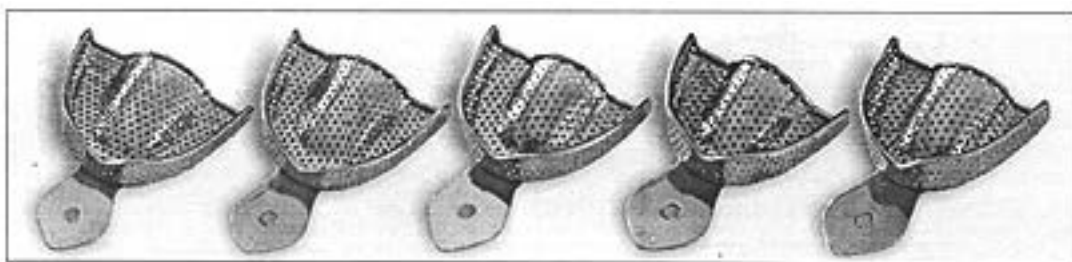
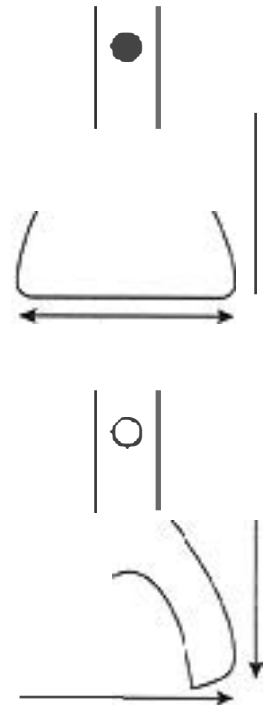

29-166 U1    29-167 U2    29-168 U3    29-169 U4    29-170 U5

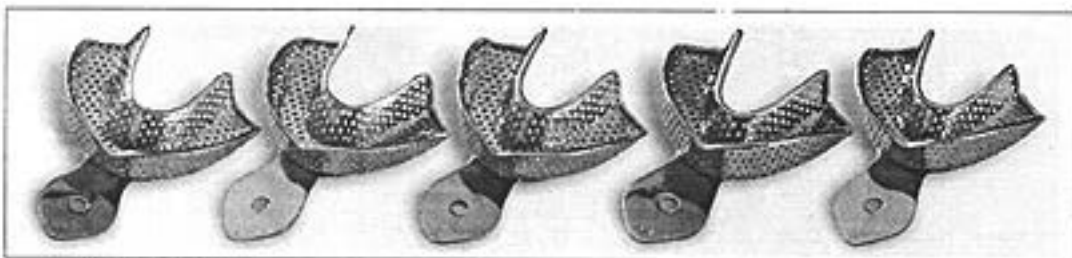

29-171-L1    29-172 L2    29-173-L3    29-174-L4    29-175-L5



## REGULAR ( Rim Lock )

29-009-44  
 Set of 6 Pieces

### UPPER

Numbers	Size	mm.	mm.
29-176-U1	S	55	41
29-177-U2	M	62	49
29-178-U3	L	63	48

### LOWER

Numbers	Size	mm.	mm.
29-179-L1	S	55	44
29-180-L2	M	63	52
29-181-L3	L	69	58

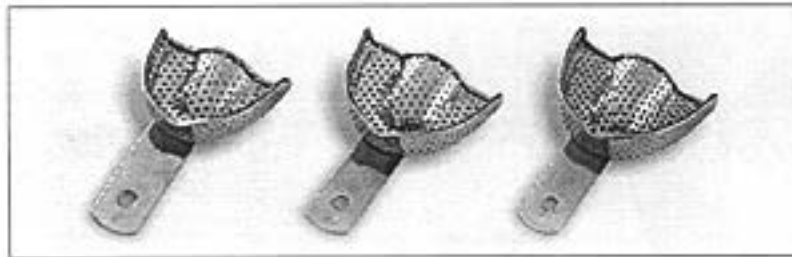
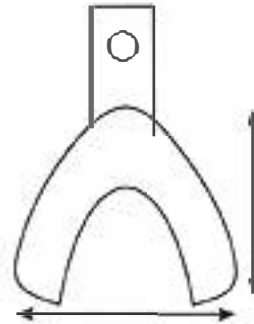
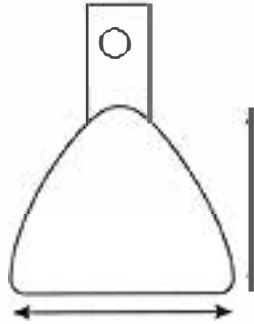

29-176-U1

29-177-U2

29-178-U3

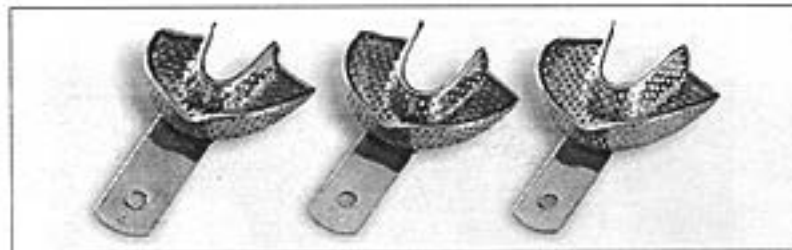

29-179-L1

29-180-L2

29-181-L3



STAINLESS STEEL IMPRESSION TRAYS  
 ABDRUCKLOFFEL AUS EDELSTAHL  
 CUBETAS PARA DE ACERO INOXIDABLE

**REGULAR ( Rim Lock )**

29-010-00

Set of 12 Pieces



Numbers	Size	mm	mm
29-087-U1	XXS	61	47
29-088-U2	XS	64	51
29-089-U3	S	68	53
29-090-U4	M	69	57
29-091-U5	L	71	60
29-092-U6	XL	73	62

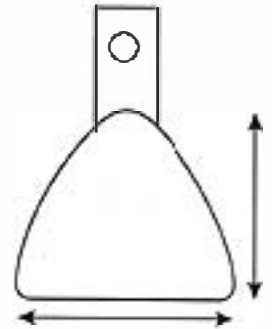

Numbers	Size	mm	mm
29-093-L1	XXS	55	47
29-094-L2	XS	60	49
29-095-L3	S	72	54
29-096-L4	M	75	57
29-097-L5	L	76	59
29-098-L6	XL	78	61

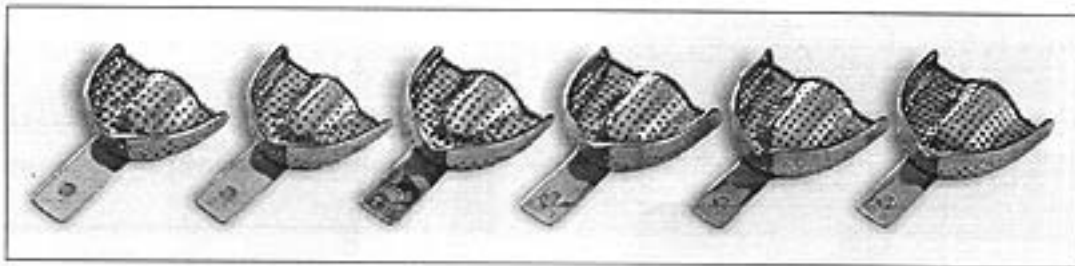
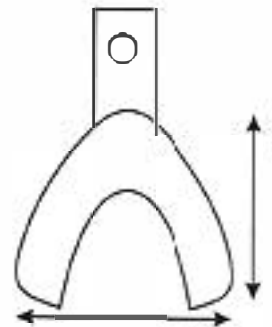

29-087-U1    29-088-U2    29-089-U3    29-090-U4    29-091-U5    29-092-U6

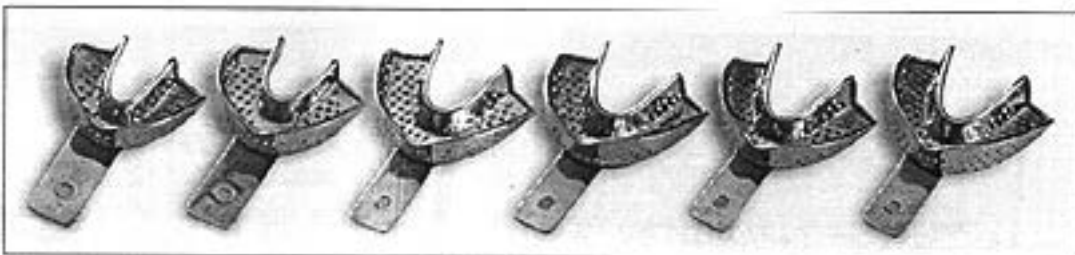

29-093-L1    29-094-L2    29-095-L3    29-096-L4    29-097-L5    29-098-L6





## Crown and bridge work Impression trays STAINLESS STEEL

29-011-00

► Set of 6 pieces

Number	Size
29-099-L6D	L
29-100-L4D	M
29-101-L2D	S

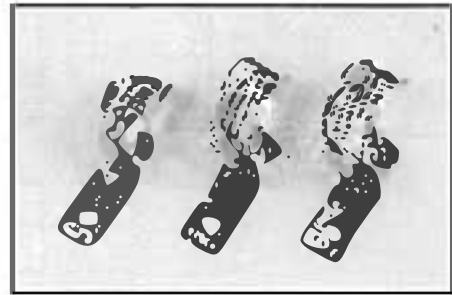

29-101-L2D 29-100-L4D 29-099-L6D

Number	Size
29-102-L6S	L
29-103-L4S	M
29-104-L2S	S

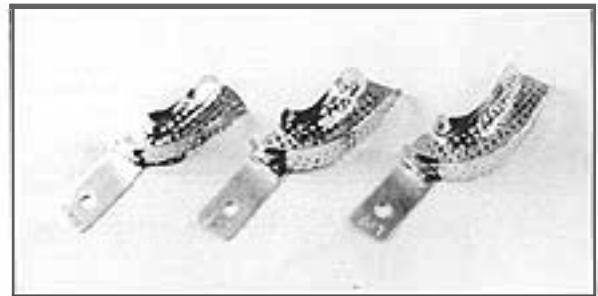

29-104-L2S 29-103-L4S 29-102-L6S

Number	Model
29-030-U1P	UPPER
29-031-L1P	LOWER

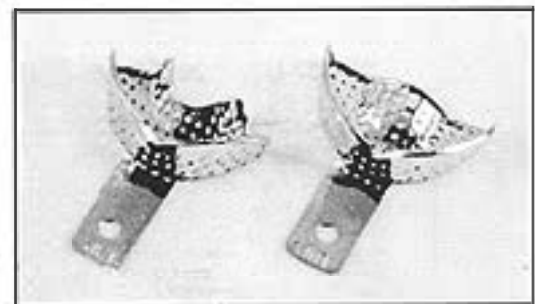

29-106-U1P 29-105-L1P



**29-012-00**

Set of 12 Pieces (Without Rim Lock)

Numbers	Size	mm.	mm.
29-107-U1	XXS	61	47
29-108-U2	XS	64	51
29-109-U3	S	66	53
29-110-U4	M	69	57
29-111-U5	L	71	60
29-112-U6	XL	73	62

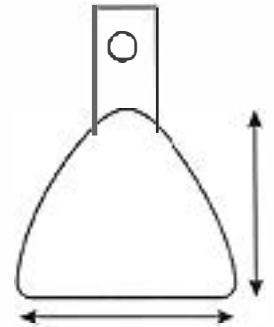

Numbers	Size	mm.	mm.
29-113-L1	XXS	55	47
29-114-L2	XS	60	49
29-115-L3	S	72	54
29-116-L4	M	75	57
29-117-L5	L	76	59
29-118-L6	XL	78	61

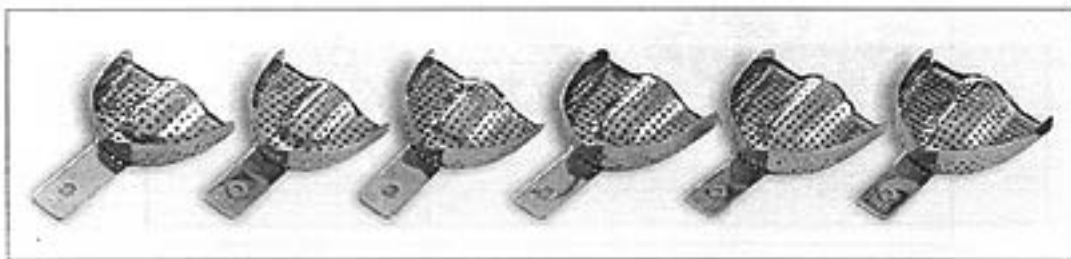
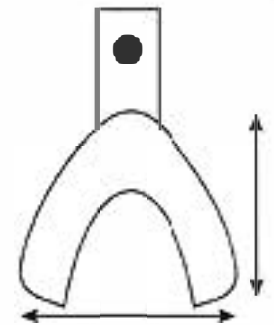

29-107-U1    29-108-U2    29-109-U3    29-110-U4    29-111-U5    29-112-U6

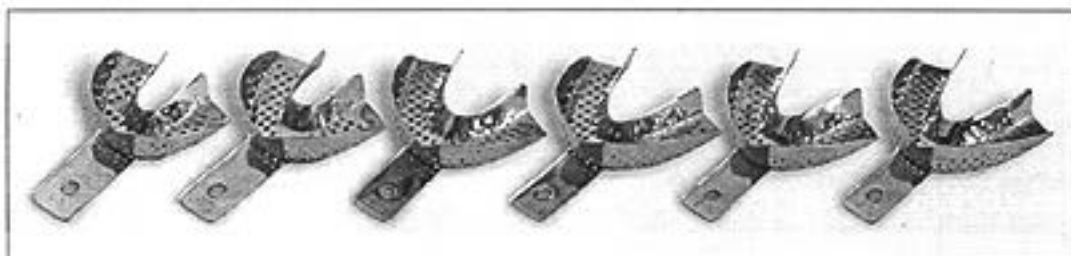

29-113-L1    29-114-L2    29-115-L3    29-116-L4    29-117-L5    29-118-L6



**DEPRESSED ANTERIOR ( Rim Lock )**

29-013-00

Set of 6 pieces

Numbers	Size	mm.	mm.
29-119-U7	L	81	67
29-120-U4	M	71	64
29-121-U1	S	70	57

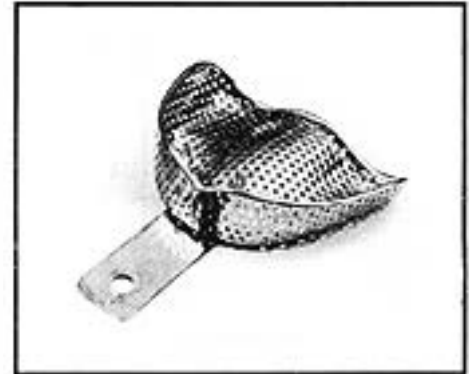
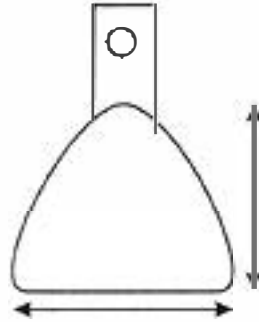

Numbers	Size	mm.	mm.
29-122-L22	L	81	60
29-123-L21	M	79	57
29-124-L20	S	76	54

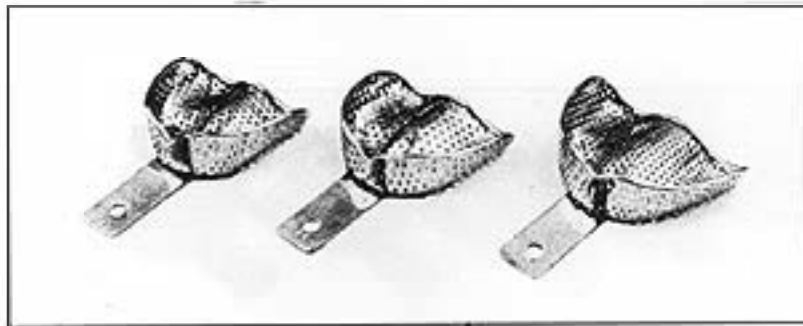
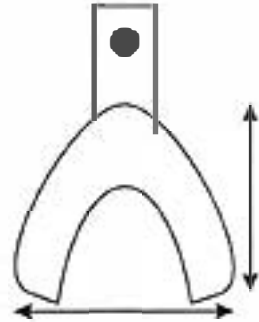

29-121-U1      29-120-U4      29-119-U7

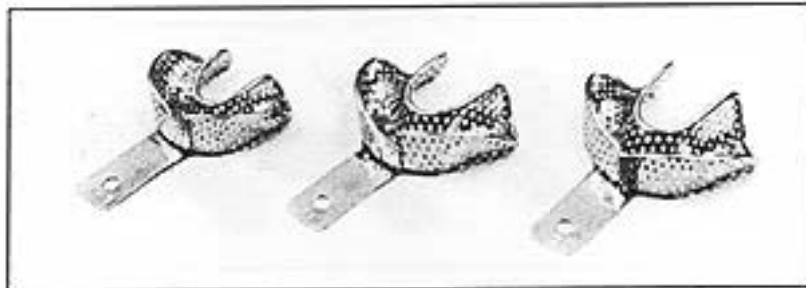

29-124-L20      29-123-L21      29-122-L22



### DENTURE / EDENTOLOUS

29-014.00

Set of 8 pieces



Numbers	Size	mm.	mm.
29-125-U64	L	79	70
29-126-U63	M	76	67
29-127-U62	NM	70	64
29-128-U61	S	73	60

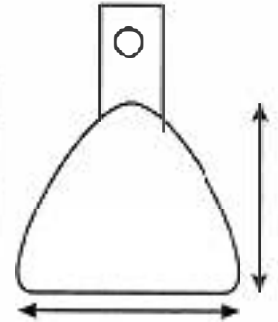

Numbers	Size	mm.	mm.
29-129-L69	L	86	64
29-130-L68	NL	73	60
29-131-L67	M	70	64
29-132-L66	S	70	57

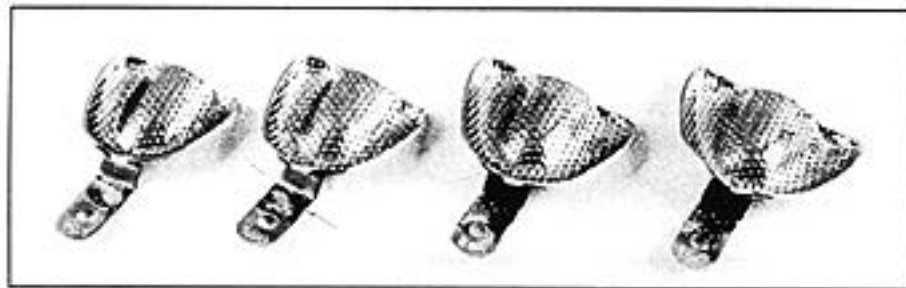
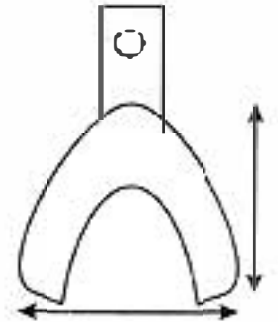

29-128-U61

29-127-L62

29-126-U63

29-125-U64

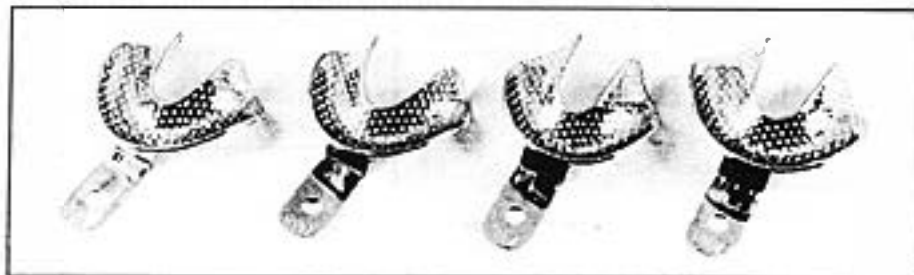

29-132-L66

29-131-L67

29-130-L68

29-129-L69

STAINLESS STEEL IMPRESSION TRAYS  
 ABDRUCKLOFFEL AUS EDELSTAHL  
 CUBETAS PARA DE ACERO INOXIDABLE



## EHRICKE ( Non Perforated )

Numbers	Size
29-185-U01	U01
29-186-U02	U02
29-187-U03	U03



Numbers	Size
29-188-UU1	UU1
29-189-UU2	UU2
29-190-UU3	UU3



Numbers	Size
29-191-B00	B00
29-192-B01	B01
29-193-B02	B02
29-194-B03	B03
29-195-B04	B04



Numbers	Size
29-196-BU0	BU0
29-197-BU1	BU1
29-198-BU2	BU2
29-199-BU3	BU3
29-200-BU4	BU4



Numbers	Size
29-201-PU1	PU1
29-202-PU2	PU2
29-203-PU3	PU3



Numbers	Size
29-204-PU1	PU1
29-205-PU2	PU2
29-206-PU3	PU3



### EHRICKE ( Perforated )

Numbers	Size
29-207-U01	U01
29-208-U02	U02
29-209-U03	U03



Numbers	Size
29-210-UU1	UU1
29-211-UU2	UU2
29-212-UU3	UU3



Numbers	Size
29-213-B00	B00
29-214-B01	B01
29-215-B02	B02
29-216-B03	B03
29-217-B04	B04



Numbers	Size
29-218-BU0	BU0
29-219-BU1	BU1
29-220-BU2	BU2
29-221-BU3	BU3
29-222-BU4	BU4



Numbers	Size
29-223-PU1	PU1
29-224-PU2	PU2
29-225-PU3	PU3

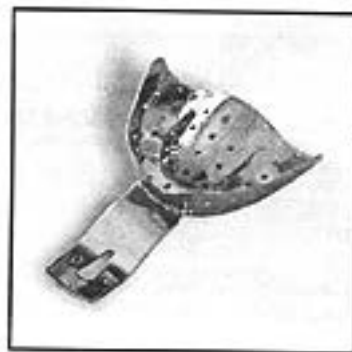

Numbers	Size
29-226-PU1	PU1
29-227-PU2	PU2
29-228-PU3	PU3



**STAINLESS STEEL IMPRESSION TRAYS  
ABDRUCKKLOFFEL AUS EDELSTAHL  
CUBETAS PARA DE ACERO INOXIDABLE**



**NEW**

**EDENTULOUS**

29-018-44

Set of 11 Pieces ( Without Rim Lock )

Numbers	Size	mm	mm
29-230-L1	XXS	60	50
29-231-U2	XS	64	54
29-232-L3	S	68	58
29-233-U4	M	70	59
29-234-U5	L	78	54

Numbers	Size	mm	mm
29-235-L1	XXS	59	54
29-236-L2	XS	67	55
29-237-L3	S	70	58
29-238-L4	M	74	56
29-239-L5	L	75	60
29-240-L6	XL	80	62

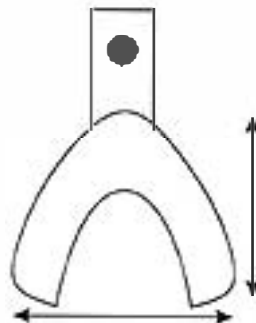
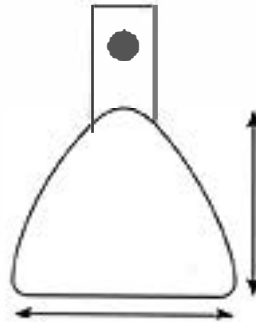

29-230-U1    29-231-U2    29-232-U3    29-233-U4    29-234-U5



29-235-L1    29-236-L2    29-237-L3    29-238-L4    29-239-L5    29-240-L6

Department

30

TRAYS AND BOWLS  
TABLETEN UND BECHER  
BANDEJAS PARA BUCALES

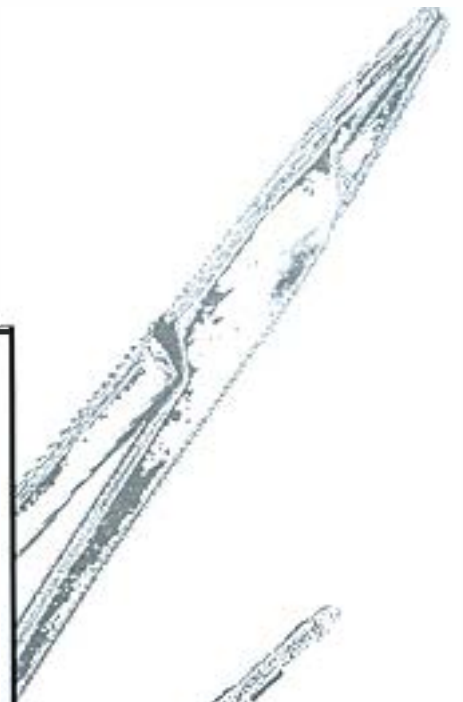



DEPARTMENT NO. 30

FROM  
PAGE#

351

TO  
PAGE#

359

INSTRUMENTS CATEGORY

TRAYS AND BOWLS  
TABLETEN UND BECHER  
BANDEJAS PARA BUCALES



ALCOHOL BURNER  
SPIRITUS LAMPE  
LAMPARA DE ALCOHOL

30

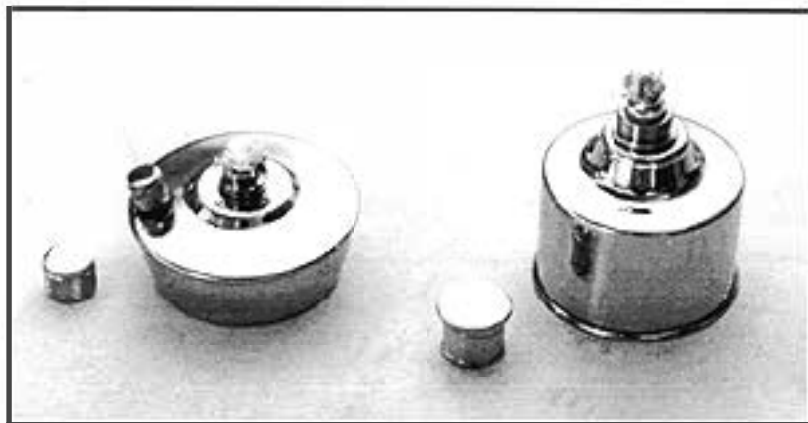

30.001-00  
4 oz

30.002-00  
4 oz  
6 oz

TRAYS AND BOWLS  
 TABLETEN UND BECHER  
 BANDEJAS PARA BUCALES



30-003-10 (10 cm)  
 30-004-12 (12 cm)  
 30-005-15 (15 cm)  
 30-006-20 (20 cm)  
 30-007-25 (25 cm)  
 Lotion Bowl

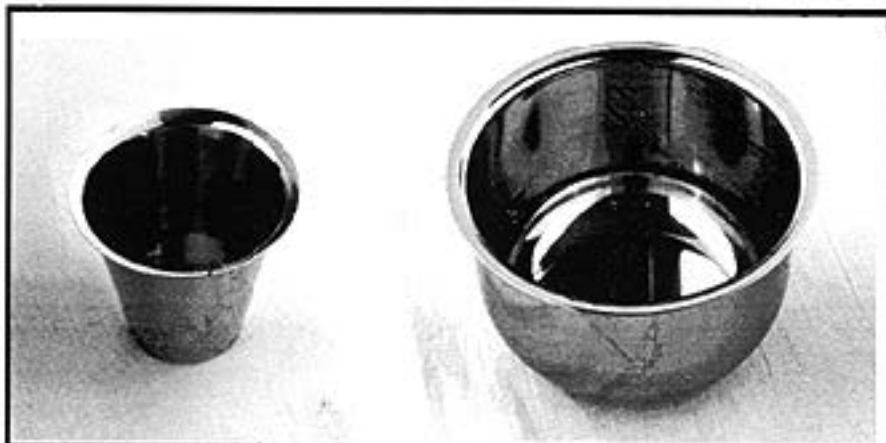
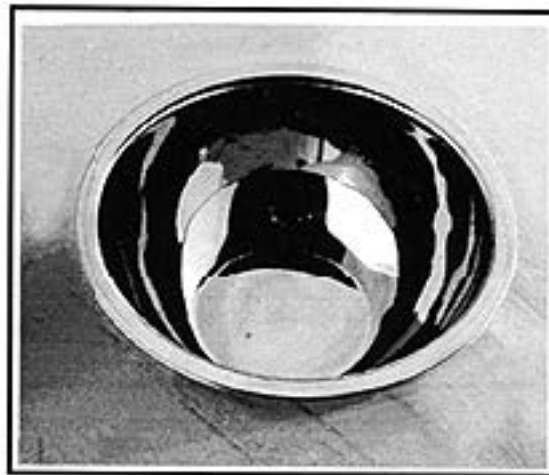

30-008-00 (50 cc)  
 30-009-00 (100 cc)  
 Medicine Cup

30-010-00 (80x50 mm)  
 Medicine Cup

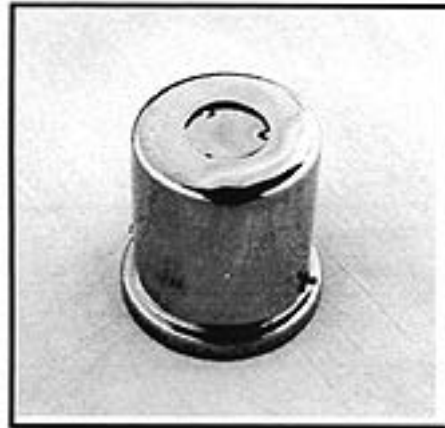

30-011-00  
 Cotton Wool Holder

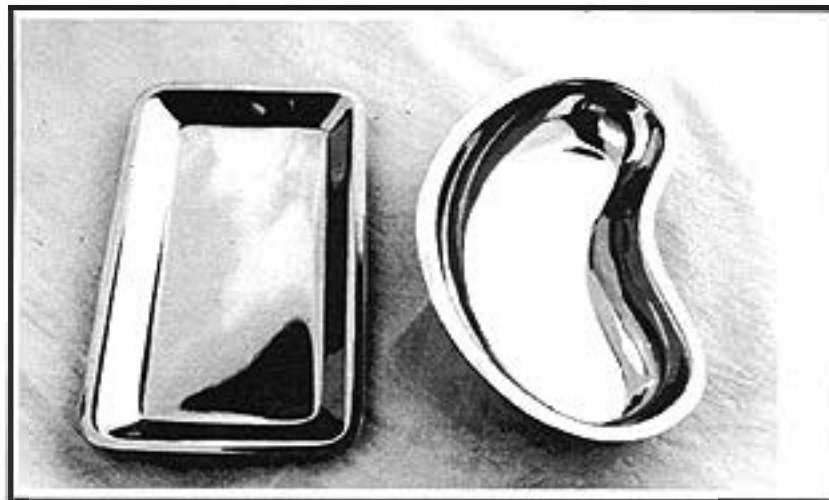

- | L         | W                | H |
|-----------|------------------|---|
| 30-012-00 | (9.2x5.4x1 cm)   |   |
| 30-013-00 | (15x10x1 cm)     |   |
| 30-014-00 | (18.5x10.5x1 cm) |   |
| 30-015-00 | (19x10x1.5 cm)   |   |
| 30-016-00 | (20x10x1 cm)     |   |
| 30-017-00 | (20x15x1 cm)     |   |
| 30-018-00 | (25x15x1 cm)     |   |
| 30-019-00 | (28x19x2 cm)     |   |
| 30-020-00 | (29x19x1 cm)     |   |
- Instrument Tray

- 30-021-12 (12 cm)
  - 30-022-15 (15 cm)
  - 30-023-20 (20 cm)
  - 30-024-25 (25 cm)
  - 30-025-30 (30 cm)
- Kidney Tray

HEAD LAMPS FOR LOW VOLTAGE CURRENT  
STIRNLAMPEN FÜR SCHWACHSTROM  
LAMPARAS FRONTALES PARA CORRIENTE DE BAJA TENSION

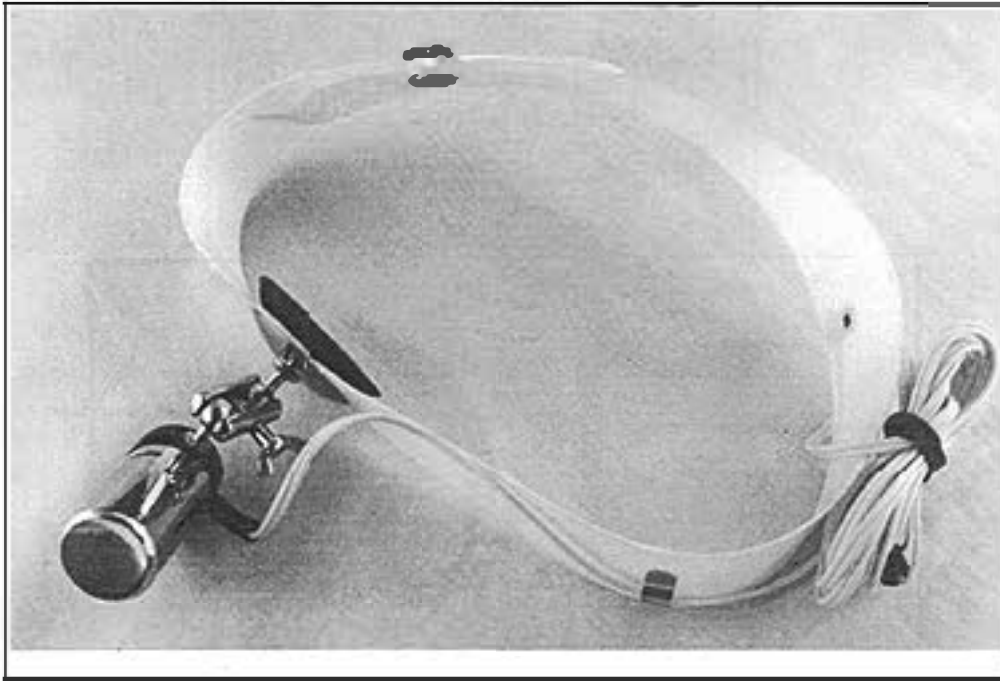
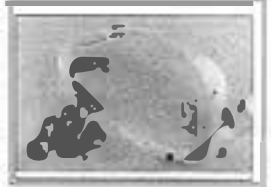

30.026.00  
Mod. Main

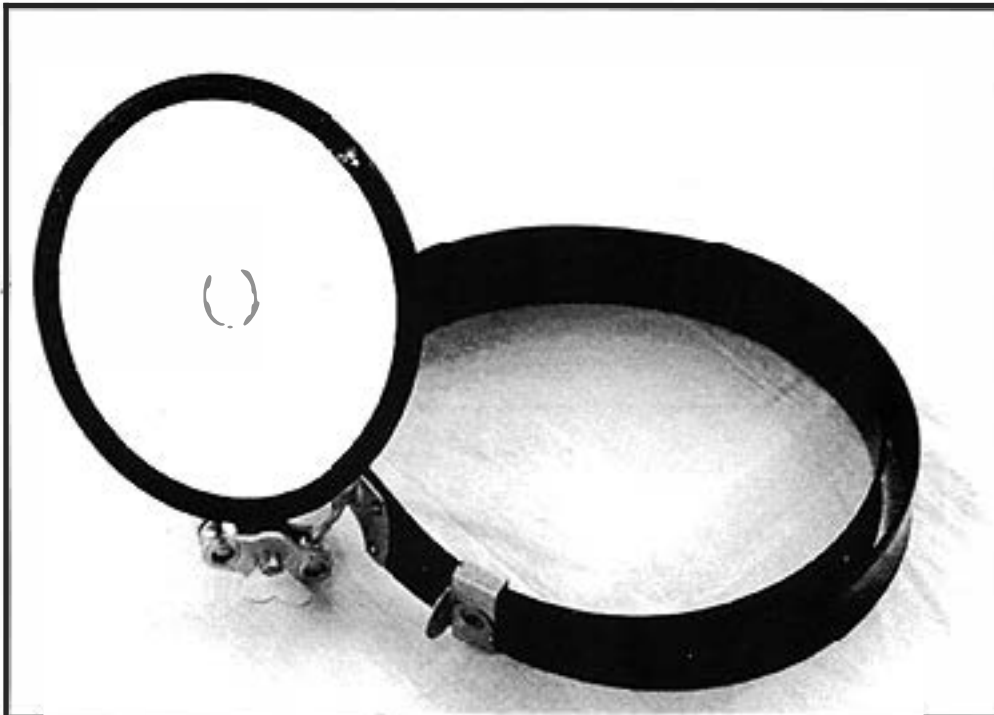

30-027-00  
Head Mirrors

NAPKIN HOLDERS  
SERVIETTENHALTER  
PORTESERVILLETAS



30-028-01



30-028-02



30-028-03



30-028-04



30-028-05



30-028-06

NAPKIN HOLDERS

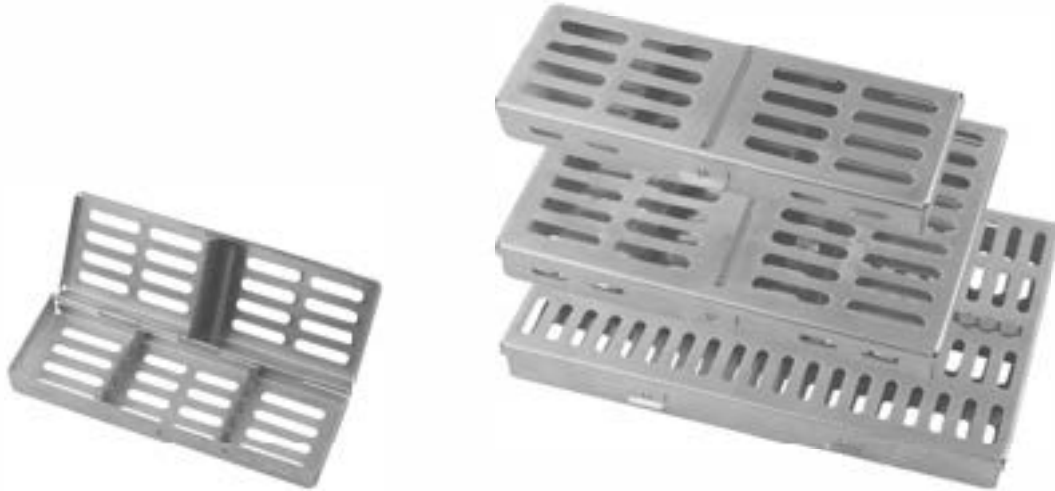

Cassette Trays with fixed lid

30-060-00	180 x 60 x 22 mm
30-061-00	180 x 140 x 22 mm
30-062-00	280 x 184 x 28 mm



Cassette Trays with detachable lid

30-065-00	180 x 70 x 35 mm
30-066-00	180 x 110 x 35 mm
30-067-00	180 x 145 x 35 mm
30-068-00	250 x 180 x 35 mm



TRAYS  
TABLETEN  
BONDEJAS

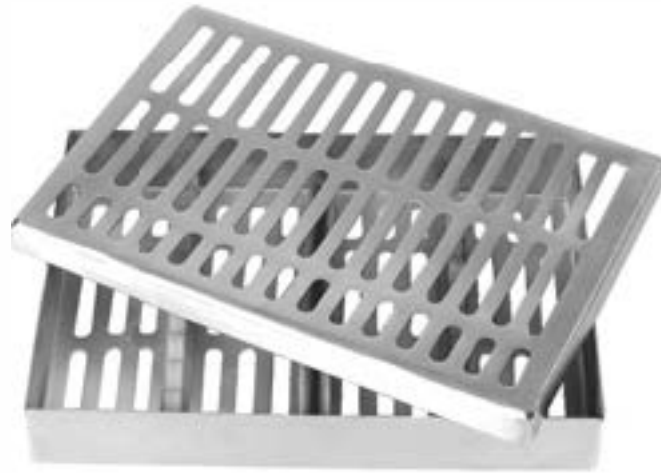

Cassette Trays

30-070-00	180 x 60 x 20 mm
30-071-00	180 x 125 x 20 mm
30-072-00	200 x 140 x 30 mm

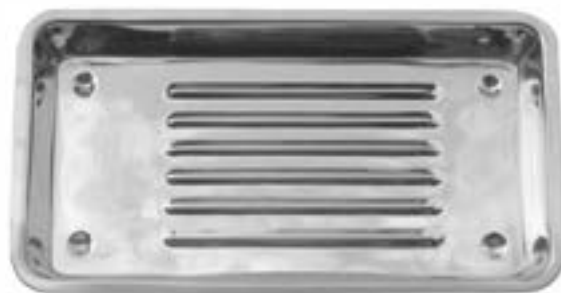

30-074-00 200 x 115 x 20 mm



30-030-00  
Film Holder



30-029-10  
Radiography Clip

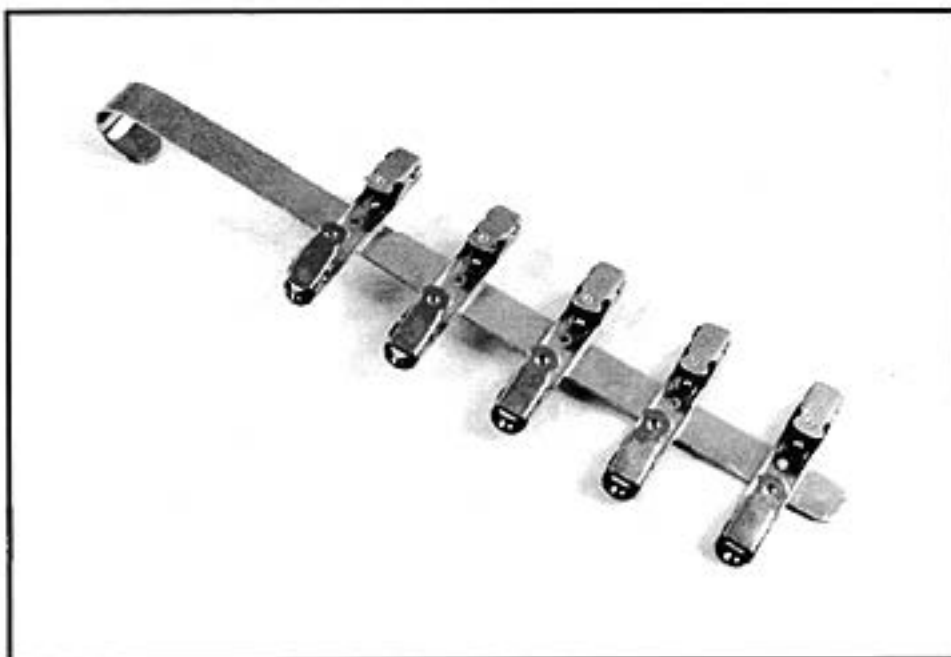

30-031-00 (With 14 Clips)  
30-032-00 (With 10 Clips)  
30-033-00 (With 6 Clips)  
Film Hangers

Department

31

ORTHODONTICS PLIERS  
ORTHODONTIE ZANGEN  
ALICATES DE ORTODONCIA

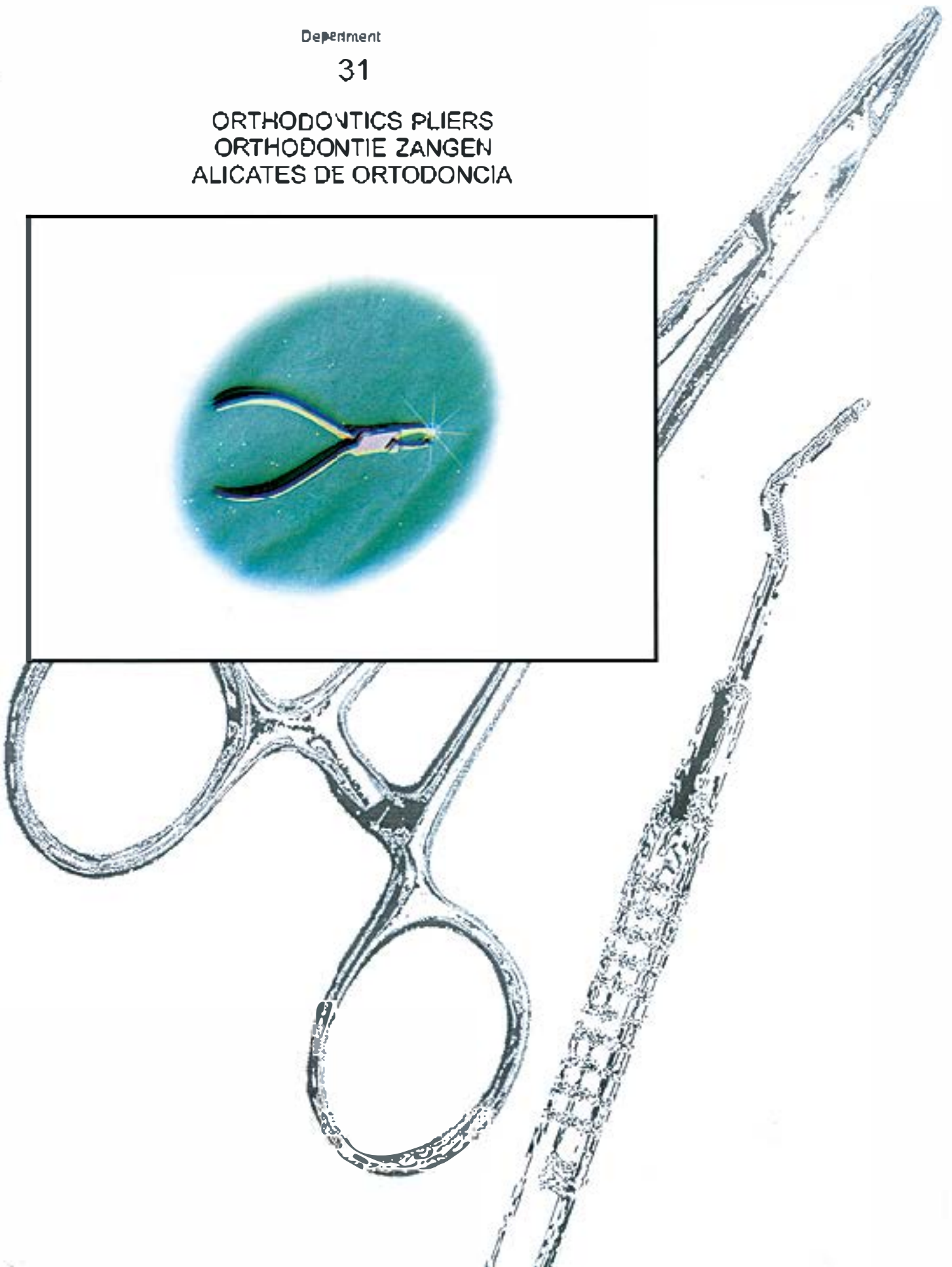
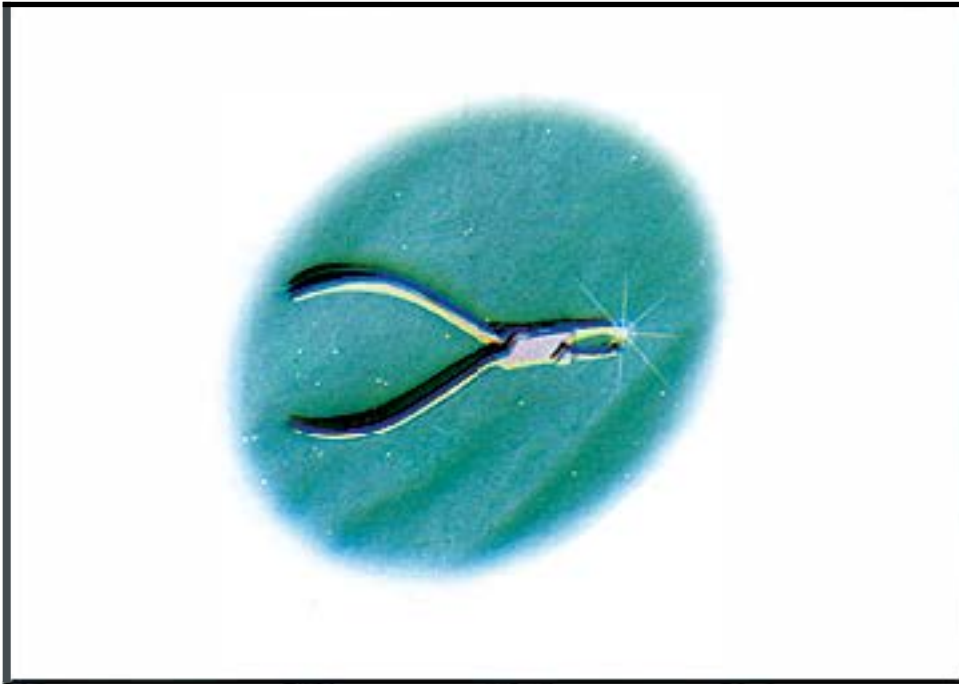

DEPARTMENT NO. 31

FROM  
PAGE#

360

TO  
PAGE#

375

INSTRUMENTS CATEGORY

ORTHODONTICS PLIERS  
ORTHODONTIE ZANGEN  
ALICATES DE ORTODONCIA

ORTHODONTICS PLIERS  
ORTHODONTIE ZANGEN  
ELICATES DE ORTODONCIA

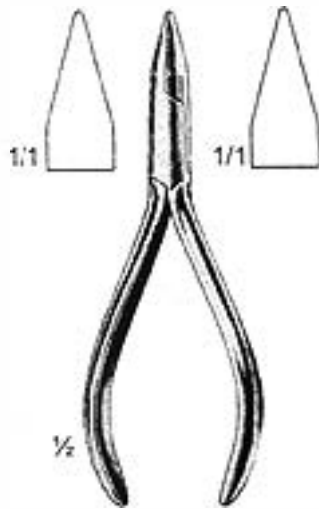

31-001-13  
13.5 cm

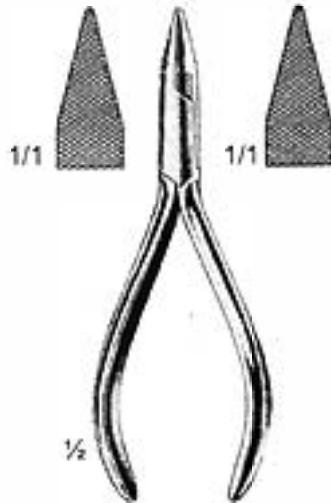

31-002-13  
13.5 cm  
Flat Nose Pliers

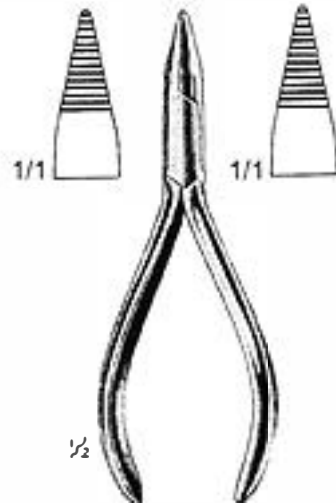

31-003-13  
13.5 cm

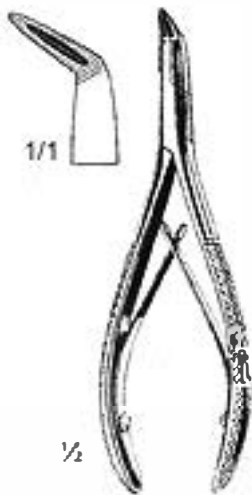

31-004-13  
13.5 cm  
Stieglitz

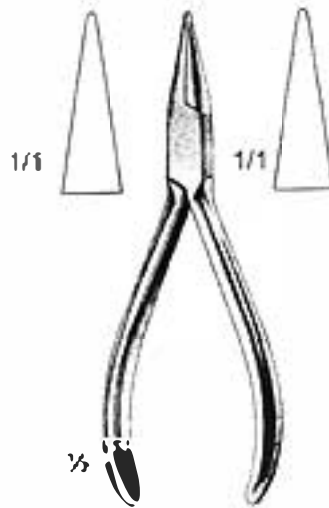

31-005-14  
14 cm

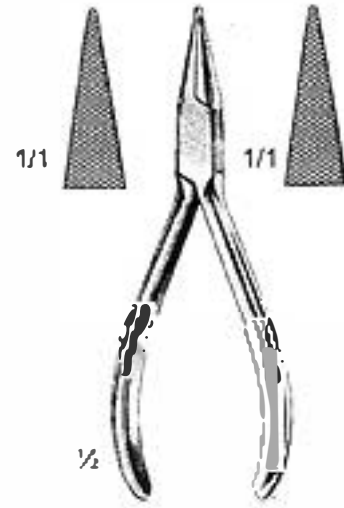

31-008-14  
14 cm

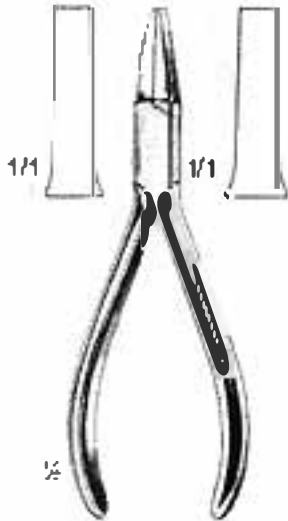

**31-007-14**  
14 cm

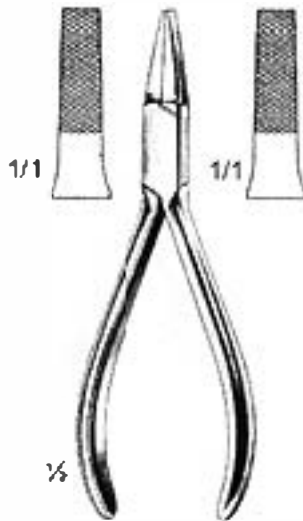

**31-008-14**  
14 cm

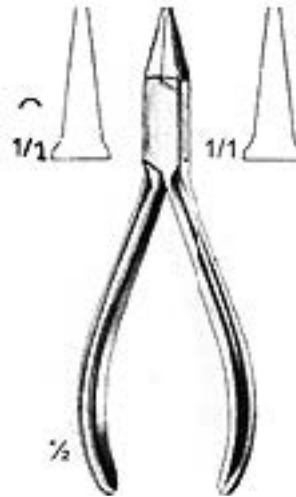

**31-009-13**  
13.5 cm

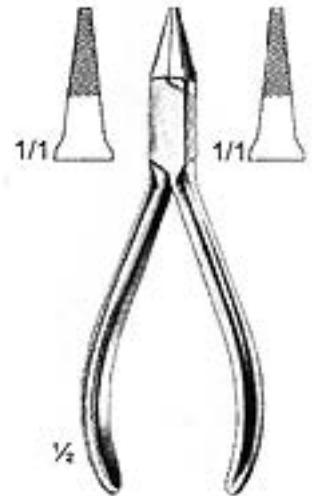

**31-010-13**  
13 cm

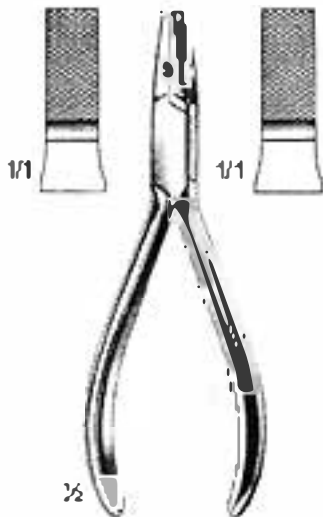

**31-011-14**  
14 cm

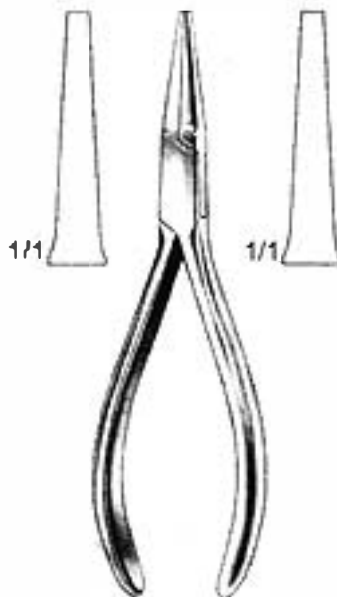

**31-012-16**  
16 cm

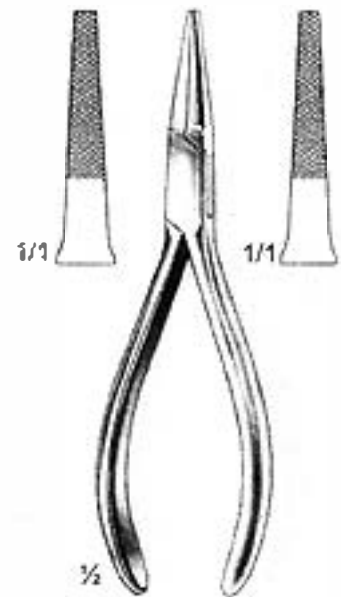

**31-013-16**  
16 cm

Langbeck

ORTHODONTICS PLIERS  
 ORTHODONTIE ZANGEN  
 ELICATES DE ORTODONCIA

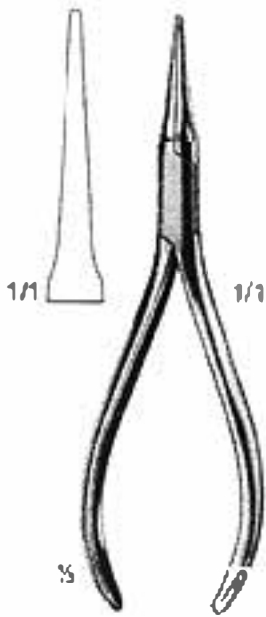
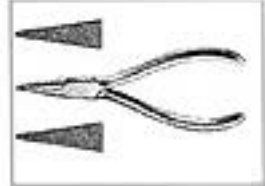

31-014-16  
 16.5 cm

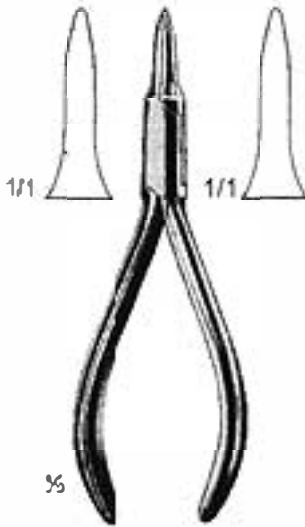

31-015-14  
 14 cm

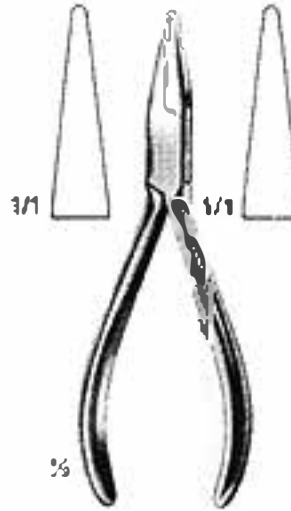

31-016-14  
 14 cm

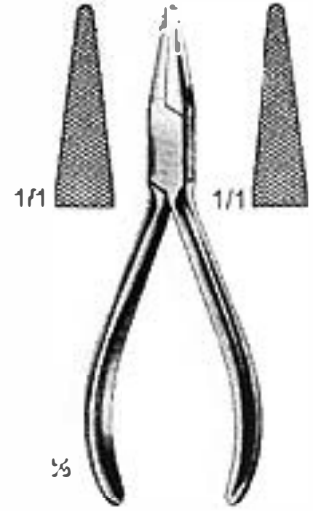

31-017-14  
 14 cm

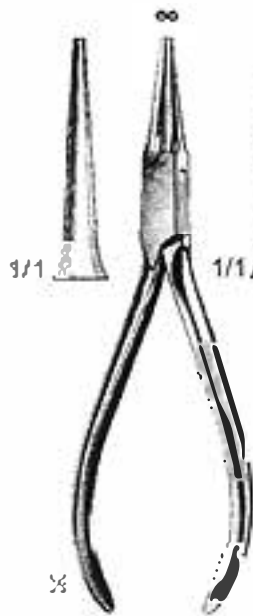

31-018-15  
 15.5 cm

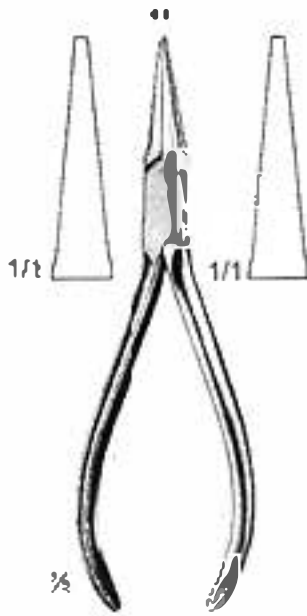

31-019-15  
 15.5 cm

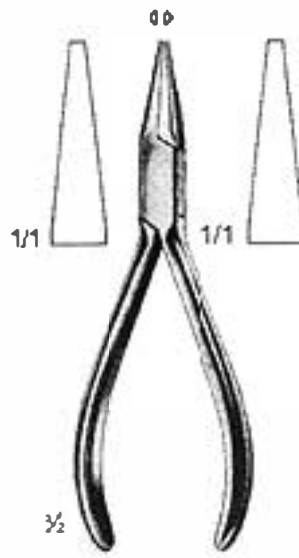

31-020-14  
 14 cm

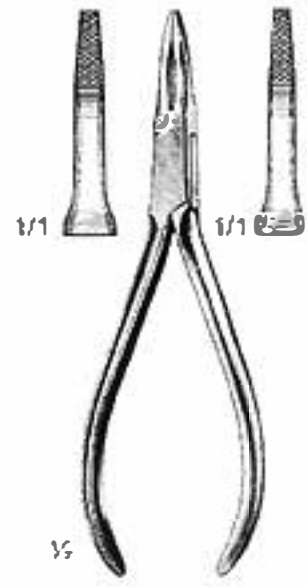

31-021-15  
 15.5 cm  
 Fischer

— Lengbeck —

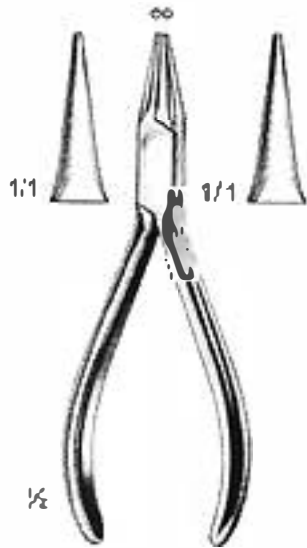
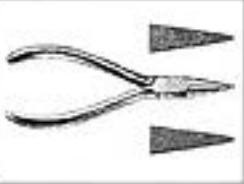

31-022-14  
 14 cm

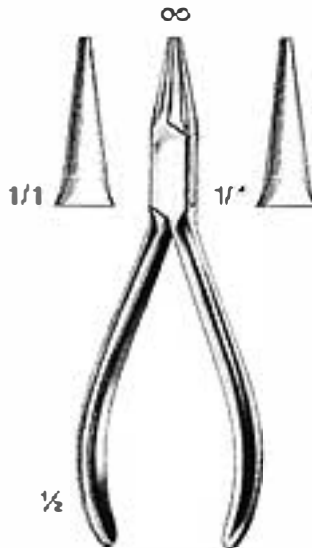

31-023-14  
 14 cm  
 Round Nose Pliers

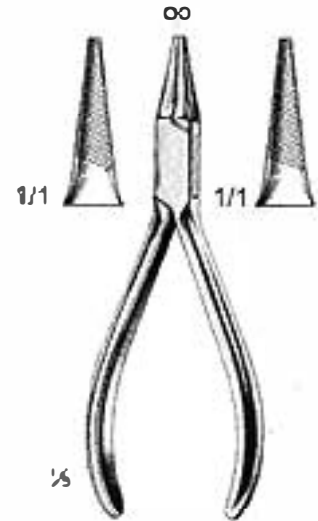

31-024-14  
 14 cm



31-025-14  
 14 cm



31-026-13  
 13 cm



31-027-13  
 13 cm



305  
 31-028-13  
 13 cm  
 Oliver

Angle



ORTHODONTICS PLIERS  
ORTHODONTIE ZANGEN  
ELICATES DE ORTODONCIA

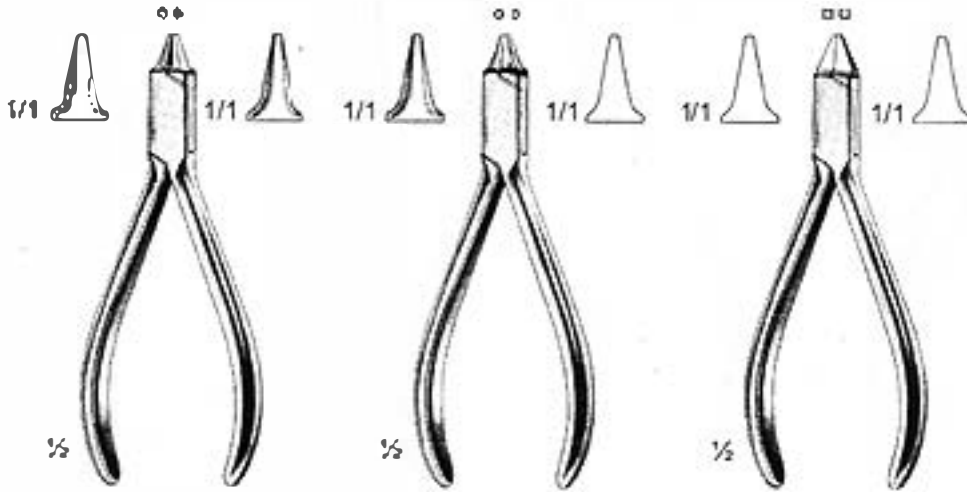
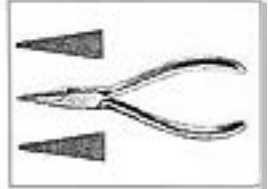

31-029-12.5  
12.5 cm

139  
31-030-12.5  
12.5 cm  
Angle

31-031-12.5  
12.5 cm  
Adams

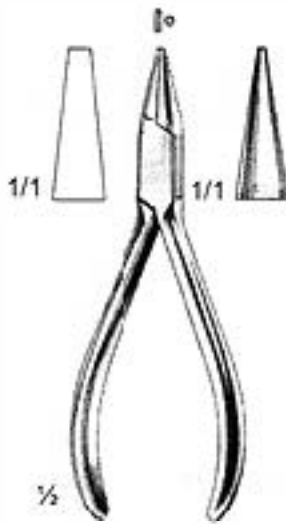

31-032-13  
13 cm

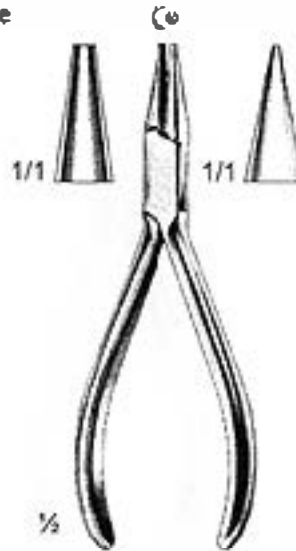

31-033-14  
14 cm  
Schwarz

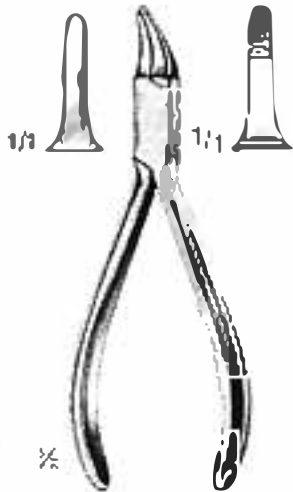
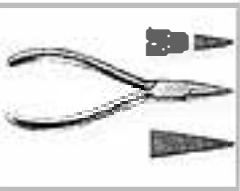

137  
31-034-13  
13.5 cm  
Gordon

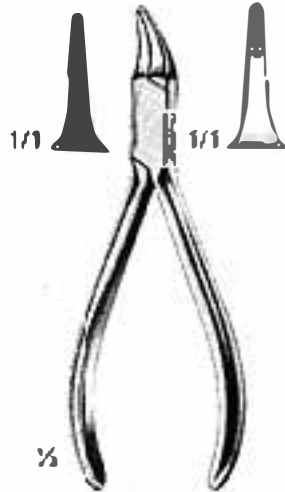

31-035-13  
13.5 cm  
USA Model

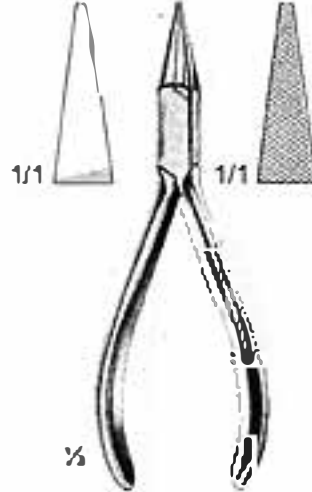

136  
31-036-13  
13.5 cm  
Goslee

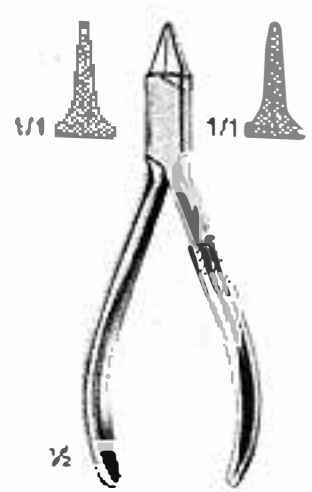

31-037-13  
13 cm  
Fievert

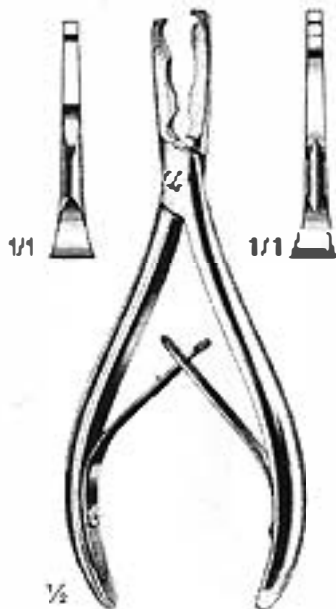

31-038-16  
16.5 cm  
Tylus

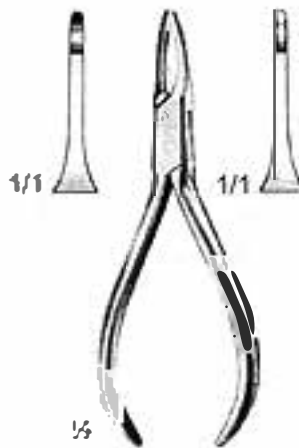

114  
31-039-12  
12 cm  
Johnson

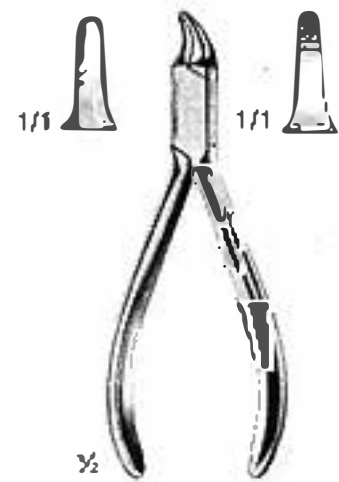

115  
31-040-13  
13 cm  
Reynolds

ORTHODONTICS PLIERS  
 ORTHODONTIE ZANGEN  
 ELICATES DE ORTODONCIA

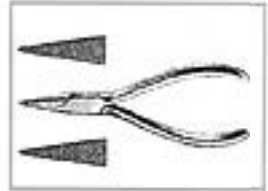

139  
 31-041-16  
 16 cm



134  
 31-042-16  
 16 cm

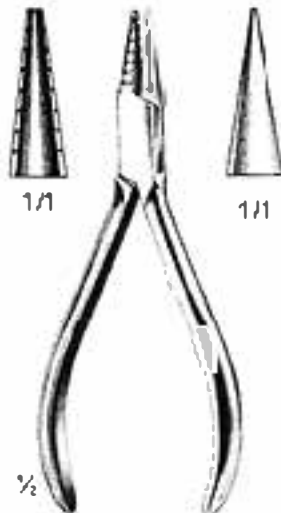

31-043-14  
 14 cm  
 Schwarz

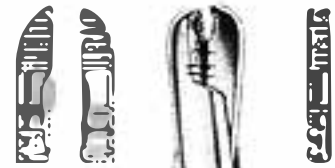

31-044-11  
 11.5 cm



200  
 31-045-13  
 13 cm

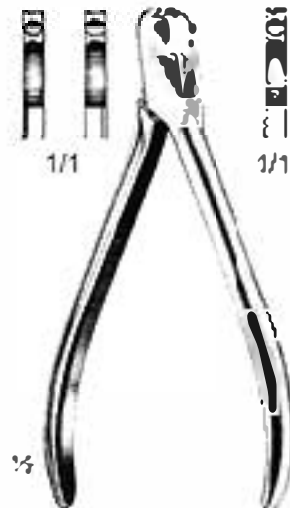

100  
 31-046-14  
 14 cm

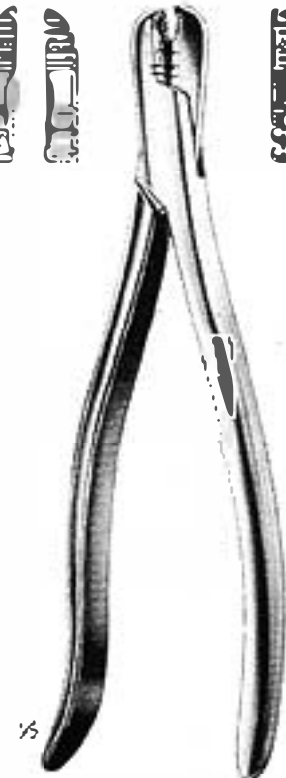

31-047-21  
 21 cm  
 Malotky

Mc Kellops

Aferer

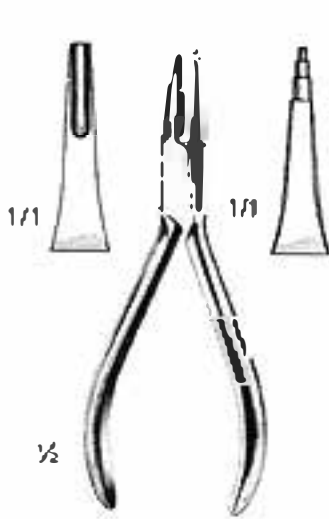

31-048-13  
13.5 cm  
Tweed

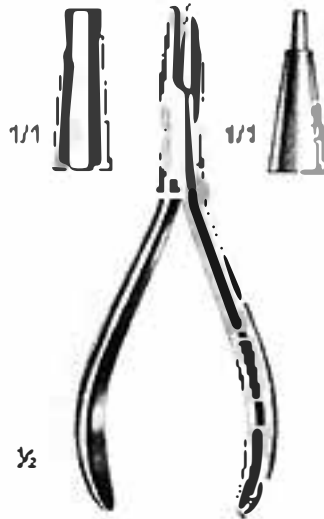

31-049-14  
14 cm  
Andresen



31-050-13  
13 cm  
Nance

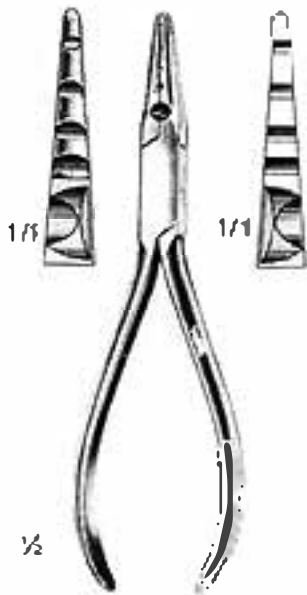

31-051-16  
16 cm

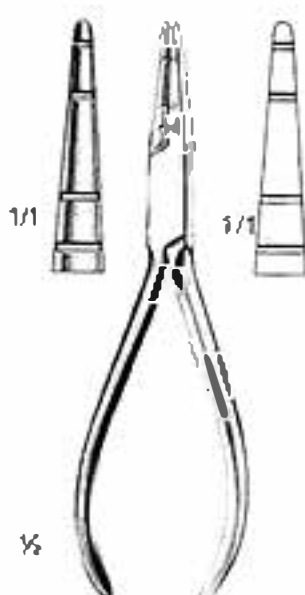

31-052-16  
16 cm  
Jelenka

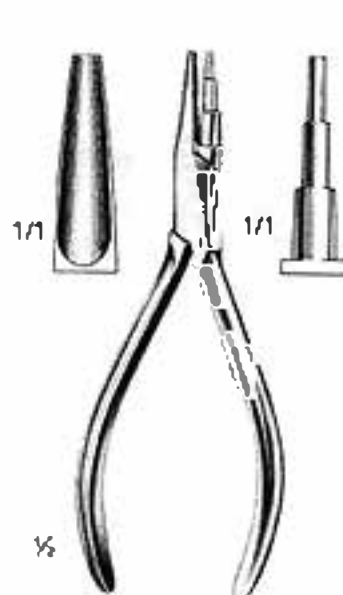

31-053-15  
15 cm

ORTHODONTICS PLIERS  
 ORTHODONTIE ZANGEN  
 ALICATES DE ORTODONCIA

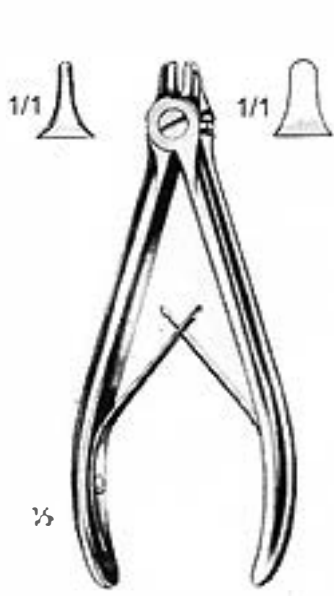
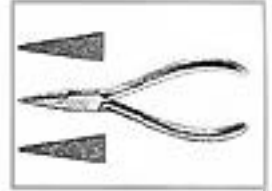

31-054-14  
 14.5 cm  
 Peeso

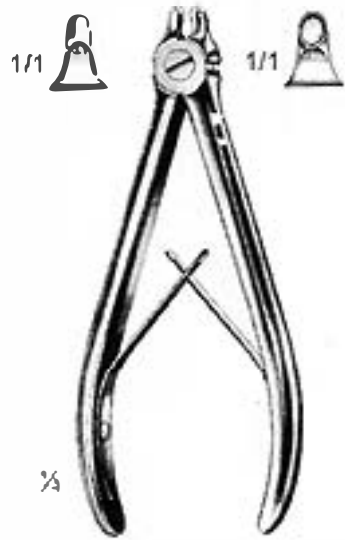

31-055-14  
 14.5 cm



31-056-14  
 14.5 cm

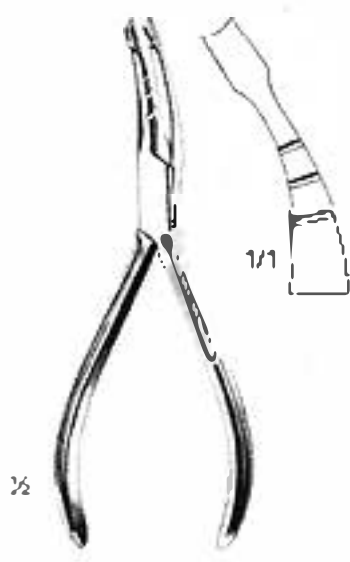

31-057-14  
 14.5 cm  
 Angle



31-058-13  
 13 cm

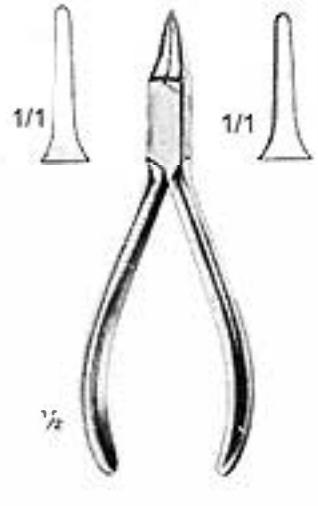

31-059-13  
 13 cm

peeso

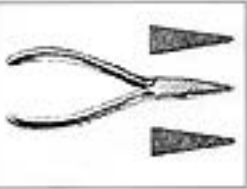

ORTHODONTICS PLIERS  
 ORTHODONTIE ZANGEN  
 ALICATES DE ORTODONCIA



1/2

31-080-16  
 16 cm  
 Saade



2/5

255  
 31-061-14  
 14 cm  
 Furrer



1/2

31-062-14  
 14 cm



1/2

31-063-13  
 13.5 cm

How



31-064-12  
 12 cm

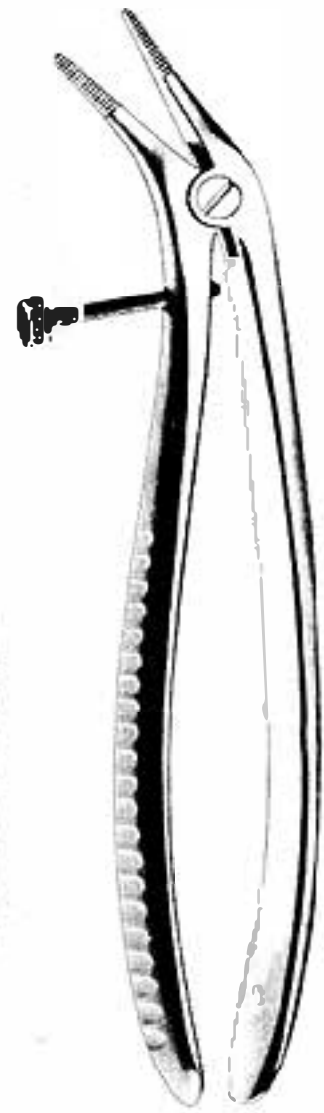

31-065-15  
 15 cm  
 Sohm

ORTHODONTICS PLIERS  
ORTHODONT E ZANGEN  
ALICATES DE CRTODONCIA

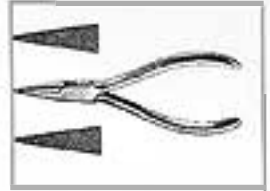

1/2

31-066-14  
14.5 cm  
Triplex



3/2

31-067-15  
15 cm  
Universal



31-068-14  
14.5 cm

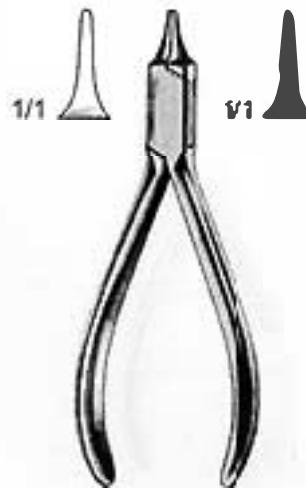

1/1

1/1

31-068-13  
13 cm  
Waldron

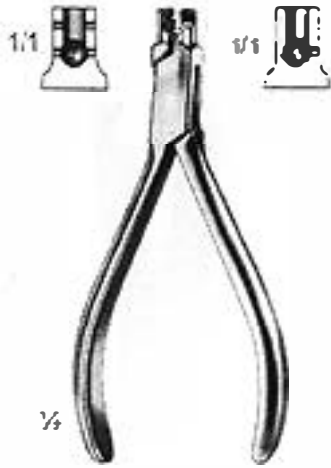

31-070-12  
12 cm  
Schwarz



31-071-13  
13 cm  
Schwarz

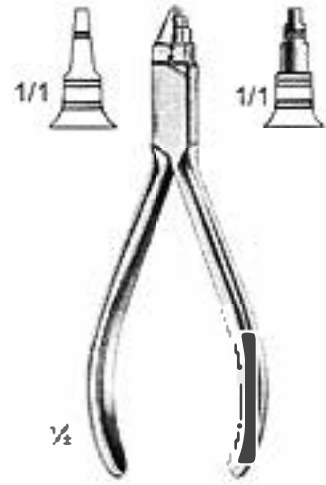

31-072-13  
13 cm  
Young

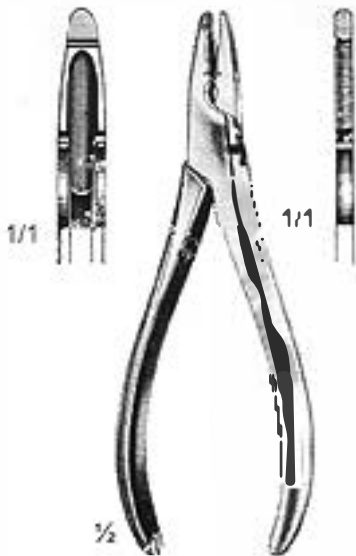

31-073-15  
15 cm  
Waldsachs



31-074-16  
16 cm



31-075-16  
16 cm



ORTHODONTICS PLIERS  
 ORTHODONTIE ZANGEN  
 ALICATES DE ORTODONCIA

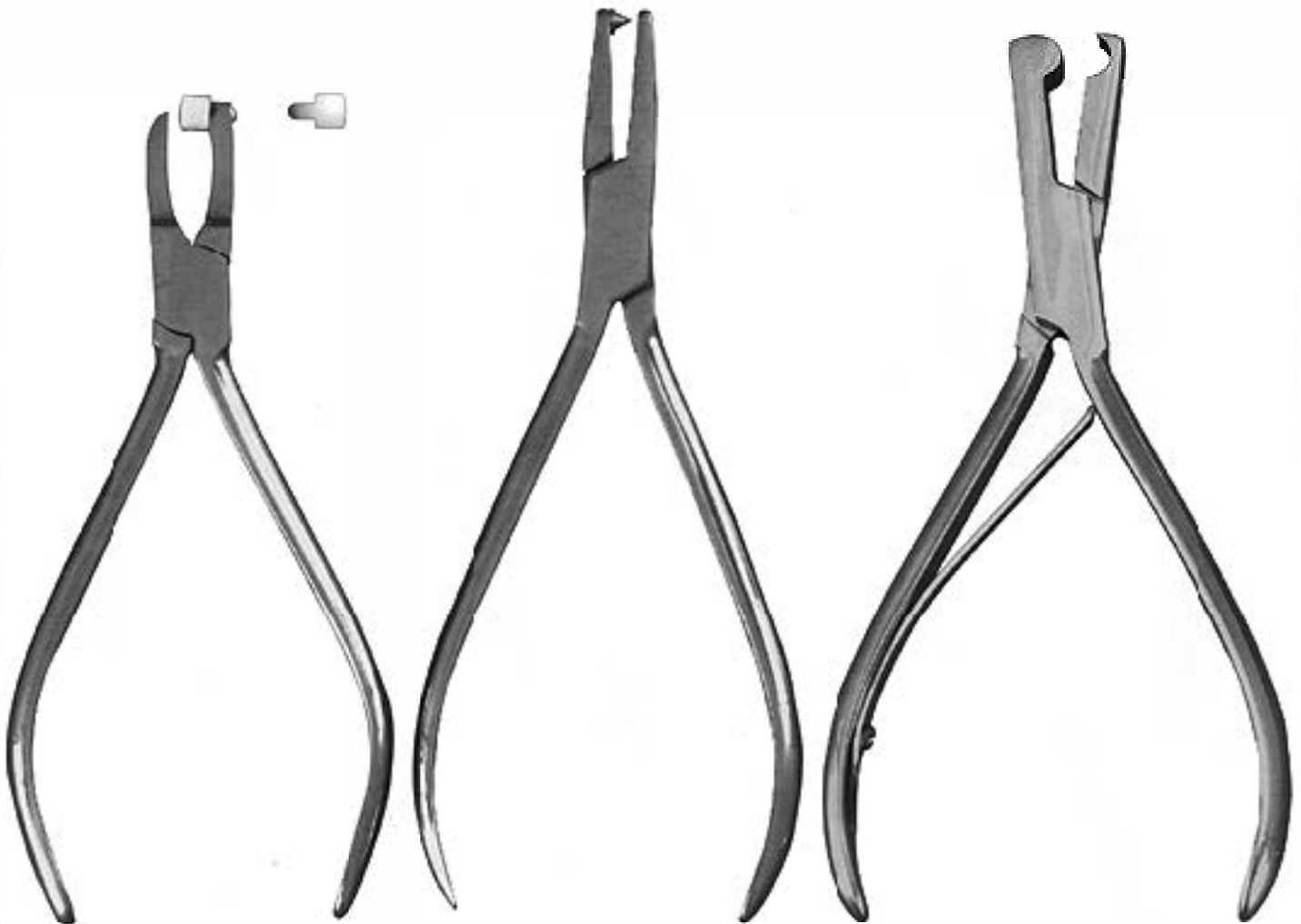
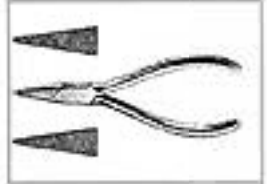

Band Removing  
 with Plastic Pad  
 12 cm  
 31-093-14

No.141  
 14 cm  
 31-092-14

De La Rosa  
 14 cm  
 31-091-14

373A

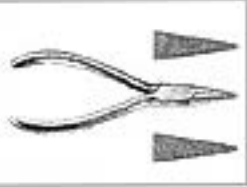

**TUNGSTEN  
CARBIDE  
INSERTS**



Ligature Cutter  
11.7 cm  
31-121-11



Distal Cutter  
11.5 cm  
31-122-11



Ligature Cutter  
11.7 cm  
31-123-11



Distal Cutter  
11.5 cm  
31-124-11

373B

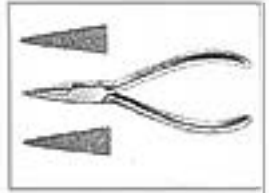

# TUNGSTEN CARBIDE INSERTS

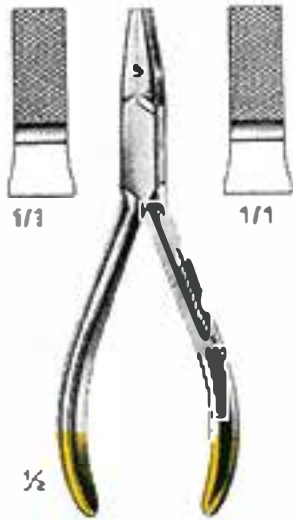

31-125-14  
14 cm

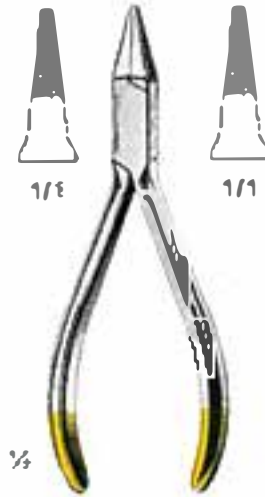

31-126-13  
13.5 cm

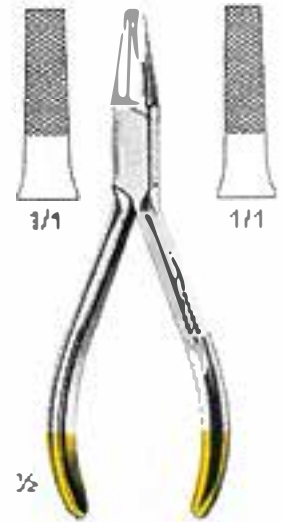

31-127-14  
14 cm

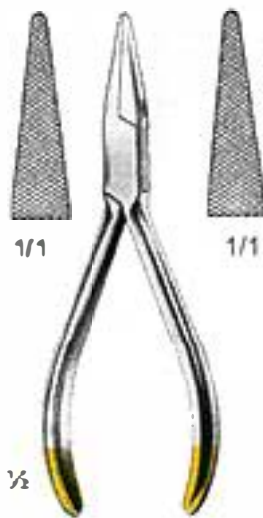

31-128-14  
14 cm

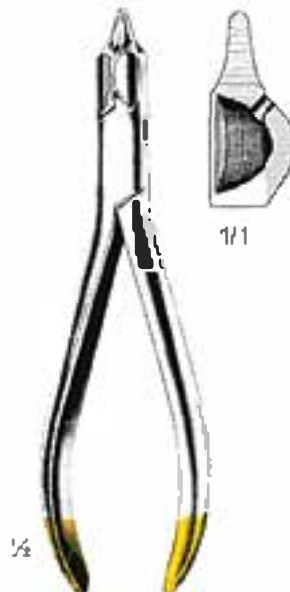

31-129-16  
16 cm  
Universal

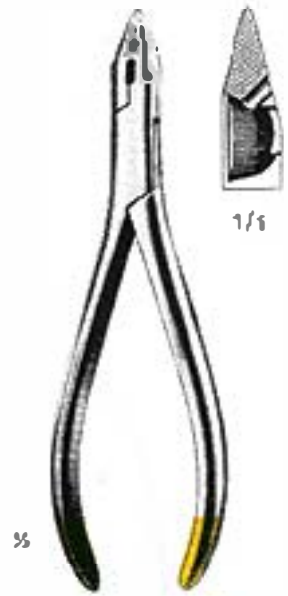

31-130-16  
16 cm  
Universal

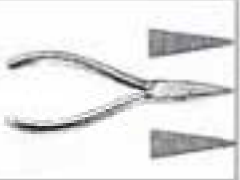

31-131-12  
12.5 cm



31-132-13  
13 cm



31-133-13  
13 cm



31-134-16  
16 cm



31-135-00



31-136-17  
17.5 cm

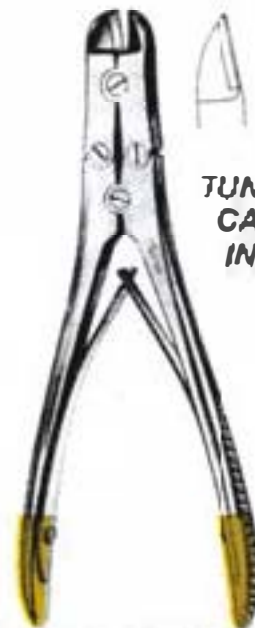

**TUNGSTEN  
 CARBIDE  
 INSERT**



31-137-12  
12 cm



1/1



Wenger  
13 cm  
31-140-43

Department

32

SCISSORS  
SCHEREN  
TIJERAS

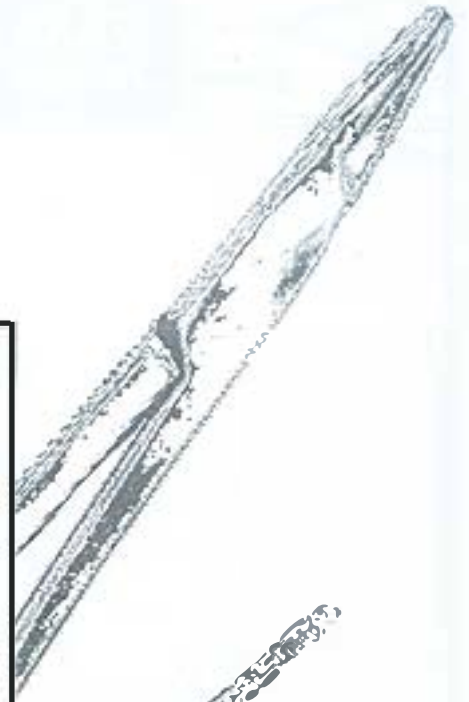
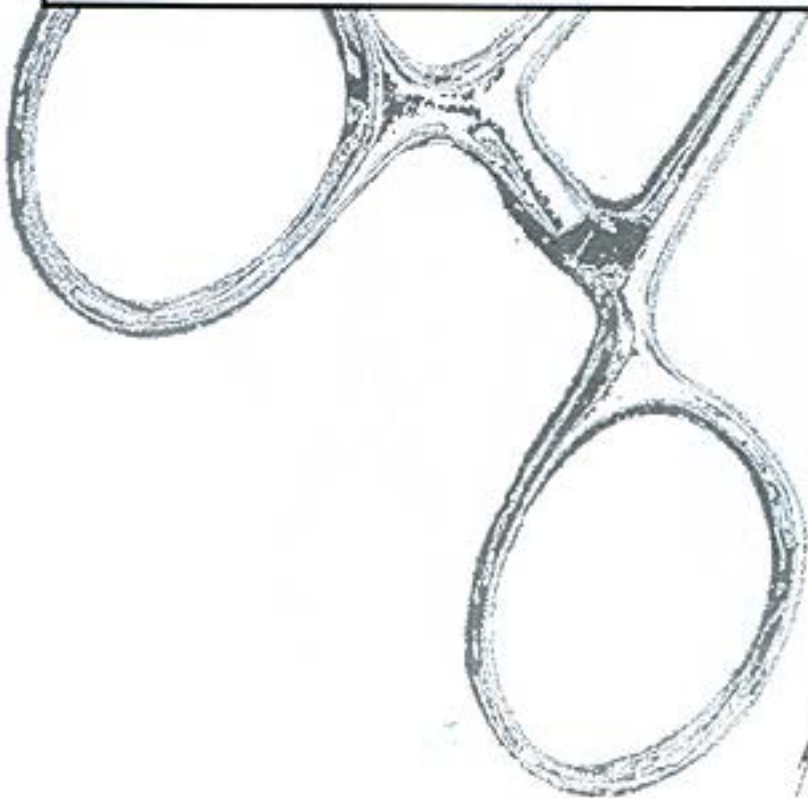

DEPARTMENT NO. 32

FROM  
PAGE#

376

TO  
PAGE#

382

INSTRUMENTS CATEGORY

SCISSORS  
SCHEREN  
TIJERAS

CUTICLE SCISSORS, NAIL FILES  
MAGELHAUTSCHEREN, NAGELFEILEN  
TIJERAS PARA UNAS, LIMES A ONGLES

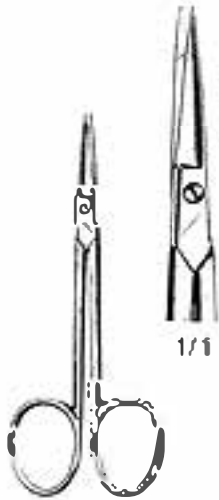

32-001-10  
10 cm

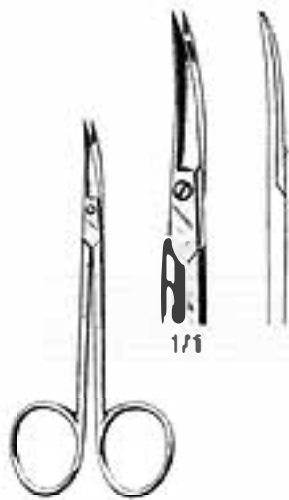

32-002-10  
10.5 cm



32-003-10  
10 cm



32-004-10  
10 cm



32-005-12  
12 cm



32-006-11  
11 cm

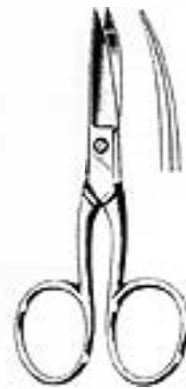

32-007-10  
10 cm

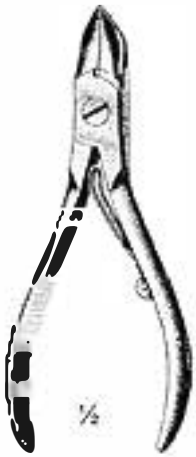

32-058-12  
 12 cm



32-059-11(11cm)  
 32-060-13(13cm)  
 32-061-15(15cm)

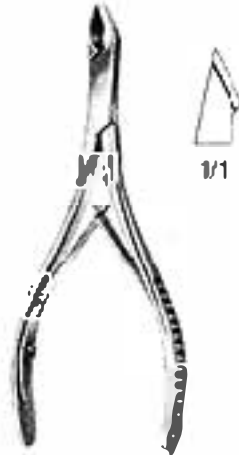

32-062-11(11cm)  
 32-063-13(13cm)

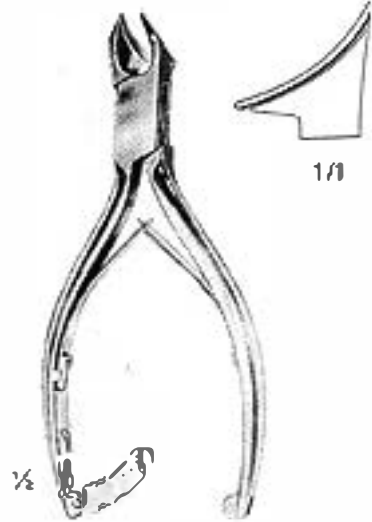

32-064-14  
 14 cm



32-065-14(14cm)  
 32-066-16(16cm)



32-067-11(11cm)  
 32-068-13(13cm)  
 Turnbull

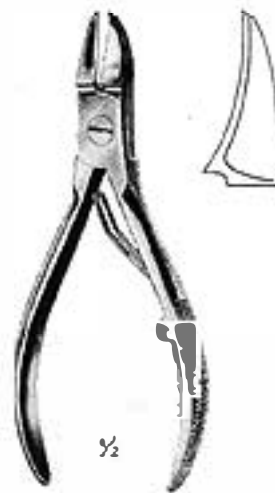

32-069-13  
 13 cm



SCISSORS  
SCHEREN  
TIJERAS

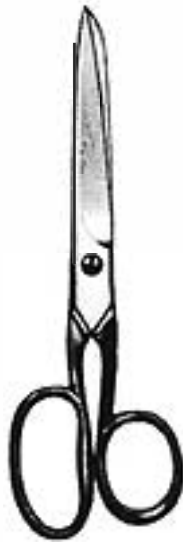
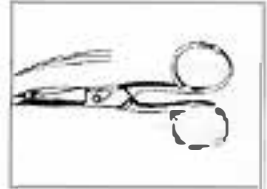

32-120-18  
18 cm



32-121-20(20 cm)  
32-122-25(25 cm)

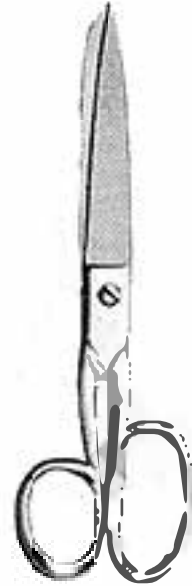

32-123-18  
18 cm



32-124-13(13 cm)  
32-125-16(16 cm)



32-126-13  
13 cm



32-127-11  
11.5 cm

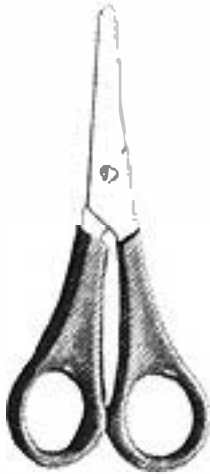

32-128-12  
12 cm

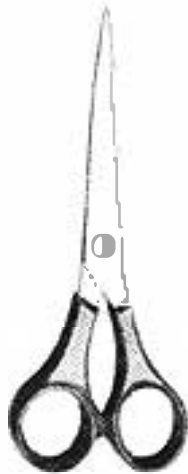

32-129-15  
15 cm

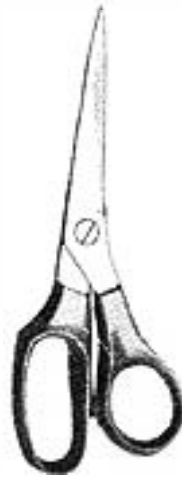

32-130-18  
18 cm



32-131-14(14.5 cm)  
32-132-18(18 cm)  
Lister



32-133-00

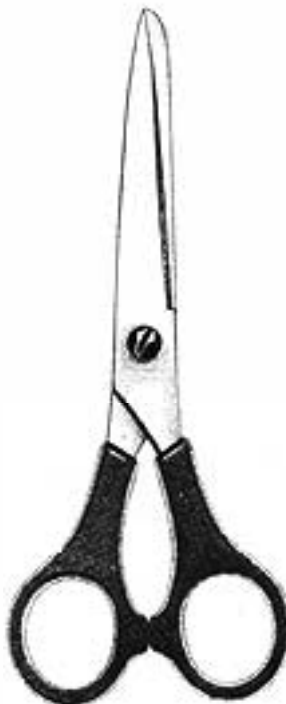

32-134-14  
14 cm



32-135-18  
18 cm  
Universal



Inquiry now Today!



+92 321 6150213



info@alfazeelatcorp.com

**Wazirabad Road, Raheem Pur  
Ugoki Sialkot, PAKISTAN**

www.alfazeelatcorp.com